

**PRODUCT
INFORMATION
SUMMARY**

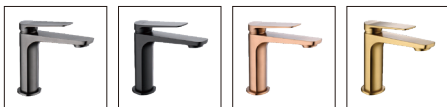

Ref.	EAN	Finish
BDN047-1	8435668034593	Chrome
BDN047-1BGM	8435668034609	Black gun metal
BDN047-1NG	8435668034616	Matte black
BDN047-1ORC	8435668034630	Brushed rose gold
BDN047-1OC	8435668034623	Brushed gold

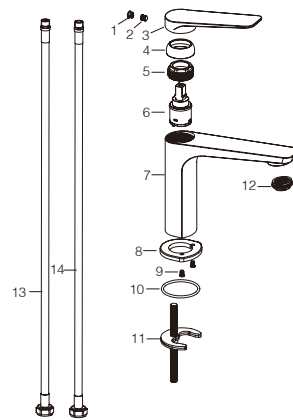

CODE	NAME	MATERIAL	REF
1	Cover	ABS	
2	Screw	SUS 304	
3	handle	Zinc	
4	Cover	ABS	
5	Nut	Brass	
6	Cartridge	26mm up	CRT004*
7	Boby	Brass	
8	Base	Brass	
9	Screw	SUS 304	
10	O-ring	NBR	
11	Single hole fixation sets	SUS 304	
12	Aerator	24x1mm	SAT-AIR072*
13	Connecting Pipe	TAQ-PEX-DN6-ACB H3/8-M10X1 L12-500-R&B	SAT-HOSES7*

* CONSULTAR PARA ACABADOS DE COLOR

Installing instruction

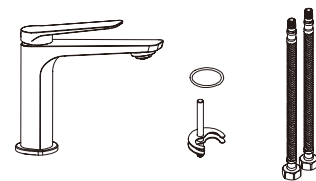

Step 1. Check all spare parts ready

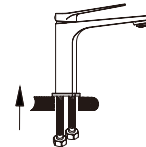

Step 2. Install inlet pipe to faucet body

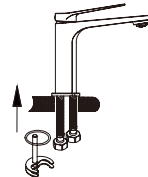

Step 3. Install screw stick to faucet body

FLOW RATE

Detalles	
FLOW RATE REF	BDN047-1
mixer water 0.1Mpa(L/MIN)	4.78
mixer water 0.3Mpa(L/MIN)	7.83
mixer water 0.5Mpa(L/MIN)	9.86
singer cold water 0.1Mpa(L/MIN)	4.44
singer cold water 0.3Mpa(L/MIN)	7.41
singer cold water 0.5Mpa(L/MIN)	9.36

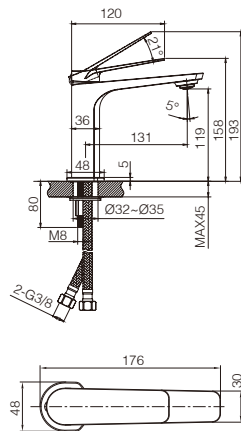
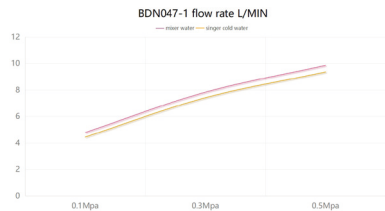

Product sizes (cm)	30*21*5.9
Weight (kg)	1.12
Guarantee	5 years
Max Preassure (bar)	5
Min Preassure (bar)	0.5
Optimum preassure (bar)	1-4 (Recommended 3)
Max. temperature	85°C
Min temperature	65°C

CERTIFIES

That all our products, provided that they are used in normal conditions or installed in accordance with current standards, are guaranteed against any manufacturing defect for a period of five years, except for products purchased before January 1, 2020, which will have the mand atory coverage of 2 years from the date of invoice.

Requirements and exclusions

Failure to comply with the instructions for assembly, use and maintenance of our products on the packaging and in our catalogue and published on our website: www.imexproducts.es, releases IMEX PRODUCTS, S.L. from any liability.

In any case, the acceptance of the defect by our technical department is necessary. In addition, transport costs will be charged only in the event that on IMEX PRODUCTS, S.L. technician determines the proper functioning of our products.

IMEX PRODUCTS, S.L. will decide to repair the product or replace it. It will be necessary to present the purchase invoice.

Assembly, maintenance or repairs carried out by non-specoalists re excluded from the warranty.

Wearing parts such as hoses, handles, seals, filters, aerators, etc. are not covered by the warranty.



**PRODUCT
INFORMATION
SUMMARY**



Ref.	EAN	Finish
BDN047-2	8435668034647	Chrome
BDN047-2BGM	8435668034654	Black gun metal
BDN047-2NG	8435668034661	Matte black
BDN047-2ORC	8435668034685	Brushed rose gold
BDN047-2OC	8435668034678	Brushed gold

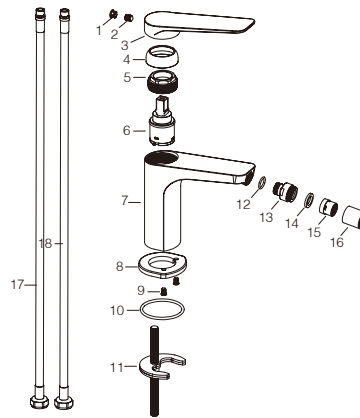

CODE	NAME	MATERIAL	REF
1	Cover	ABS	
2	Screw	SUS 304	
3	handle	Zinc	
4	Cover	ABS	
5	Nut	Brass	
6	Cartridge	26mm up	CRT007*
7	Boby	Brass	
8	Base	Brass	
9	Screw	SUS 304	
10	O-ring	NBR	
11	Single hole fixation sets	SUS 304	
12	Spout gasket	NBR	
13	Spout	Brass	
14	Gasket	NBR	
15	Aerator	16 mm	SAT-AIR032*
16	Reticulated shell	Brass	
17	Connecting Pipe	TAQ-PEX-DNG-ACB H3/8-M10X1 L12-500-R&B	SAT-HOSES7*

* CONSULTAR PARA ACABADOS DE COLOR

Installing instruction

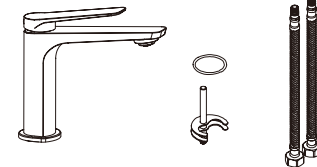

Step 1. Check all spare parts ready

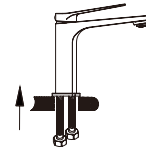

Step 2. Install inlet pipe to faucet body

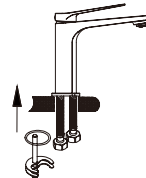

Step 3. Install screw stick to faucet body

FLOW RATE

Detalles	
FLOW RATE REF	BDN047-2
mixer water 0.1Mpa(L/MIN)	4.36
mixer water 0.3Mpa(L/MIN)	7.44
mixer water 0.5Mpa(L/MIN)	9.62
singer cold water 0.1Mpa(L/MIN)	4.39
singer cold water 0.3Mpa(L/MIN)	7.59
singer cold water 0.5Mpa(L/MIN)	9.79

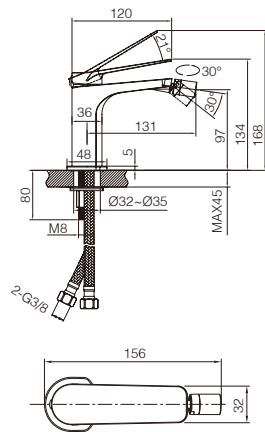
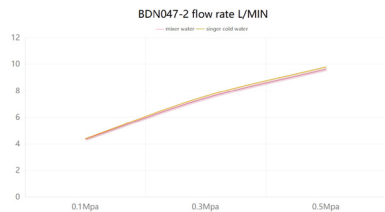

Product sizes (cm)	26.7*18.1*5.9
Weight (kg)	0.9
Guarantee	5 years
Max Preassure (bar)	5
Min Preassure (bar)	0.5
Optimum preassure (bar)	1-4 (Recommended 3)
Max. temperature	85°C
Min temperature	65°C

CERTIFIES

That all our products, provided that they are used in normal conditions or installed in accordance with current standards, are guaranteed against any manufacturing defect for a period of five years, except for products purchased before January 1, 2020, which will have the mand atory coverage of 2 years from the date of invoice.

Requirements and exclusions

Failure to comply with the instructions for assembly, use and maintenance of our products on the packaging and in our catalogue and published on our website: www.imexproducts.es, releases IMEX PRODUCTS, S.L. from any liability.

In any case, the acceptance of the defect by our technical department is necessary. In addition, transport costs will be charged only in the event that on IMEX PRODUCTS, S.L. technician determines the proper functioning of our products.

IMEX PRODUCTS, S.L. will decide to repair the product or replace it. It will be necessary to present the purchase invoice.

Assembly, maintenance or repairs carried out by non-specoalists re excluded from the warranty.

Wearing parts such as hoses, handles, seals, filters, aerators, etc. are not covered by the warranty.



**PRODUCT
INFORMATION
SUMMARY**



Ref.	EAN	Finish
BDN047-3	8435668034692	Chrome
BDN047-3BGM	8435668034708	Black gun metal
BDN047-3NG	8435668034715	Matte black
BDN047-3ORC	8435668034739	Brushed rose gold
BDN047-3OC	8435668034722	Brushed gold

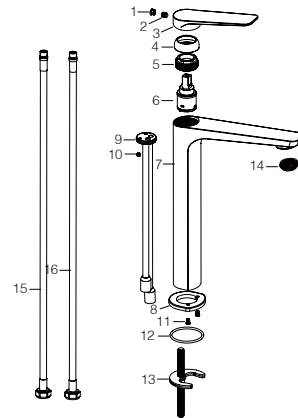

CODE	NAME	MATERIAL	REF
1	Cover	ABS	
2	Screw	SUS 304	
3	handle	Zinc	
4	Cover	ABS	
5	Nut	Brass	
6	Cartridge	26mm up	CRT007*
7	Boby	Brass	
8	Base	Brass	
9	Base	Brass	
10	Screw	SUS 304	
11	Base	Brass	
12	O-ring	NBR	
13	Single hole fixation sets	SUS 304	
14	Aerator	24x1mm	SAT-AIR072*
16	Connecting Pipe	TAQ-PEX-DN6-ACB H3/8-M10X1 L12-500-R&B	SAT-HOSES7*

* CONSULTAR PARA ACABADOS DE COLOR

Installing instruction

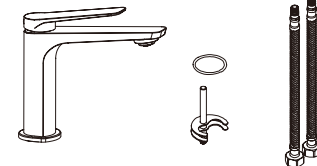

Step 1. Check all spare parts ready

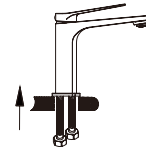

Step 2. Install inlet pipe to faucet body

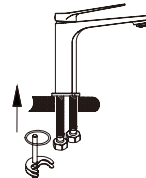

Step 3. Install screw stick to faucet body

FLOW RATE

Detalles	
FLOW RATE REF	BDN047-3
mixer water 0.1Mpa(L/MIN)	6.66
mixer water 0.3Mpa(L/MIN)	11.45
mixer water 0.5Mpa(L/MIN)	14.82
singer cold water 0.1Mpa(L/MIN)	6.11
singer cold water 0.3Mpa(L/MIN)	10.52
singer cold water 0.5Mpa(L/MIN)	13.65

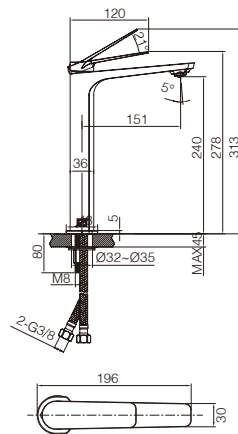

Product sizes (cm)	39*21*5.9
Weight (kg)	1.5
Guarantee	5 years
Max Preassure (bar)	5
Min Preassure (bar)	0.5
Optimum preassure (bar)	1-4 (Recommended 3)
Max. temperature	85°C
Min temperature	65°C

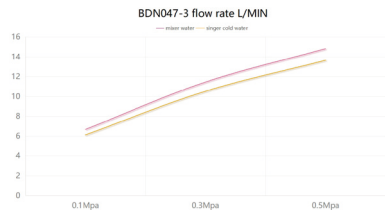

CERTIFIES

That all our products, provided that they are used in normal conditions or installed in accordance with current standards, are guaranteed against any manufacturing defect for a period of five years, except for products purchased before January 1, 2020, which will have the mand atory coverage of 2 years from the date of invoice.

Requirements and exclusions

Failure to comply with the instructions for assembly, use and maintenance of our products on the packaging and in our catalogue and published on our website: www.imexproducts.es, releases IMEX PRODUCTS, S.L. from any liability.

In any case, the acceptance of the defect by our technical department is necessary. In addition, transport costs will be charged only in the event that on IMEX PRODUCTS, S.L. technician determines the proper functioning of our products.

IMEX PRODUCTS, S.L. will decide to repair the product or replace it. It will be necessary to present the purchase invoice.

Assembly, maintenance or repairs carried out by non-specoalists re excluded from the warranty.

Wearing parts such as hoses, handles, seals, filters, aerators, etc. are not covered by the warranty.



**PRODUCT
INFORMATION
SUMMARY**

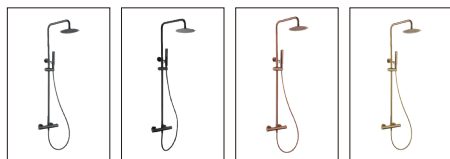

Ref.	EAN	Finish
BTN047	8435668044110	Chrome
BTN047-BGM	8435668044134	Black gun metal
BTN047-NG	8435668044158	Matte black
BTN047-ORC	8435668044196	Brushed rose gold
BTN047-OC	8435668044172	Brushed gold

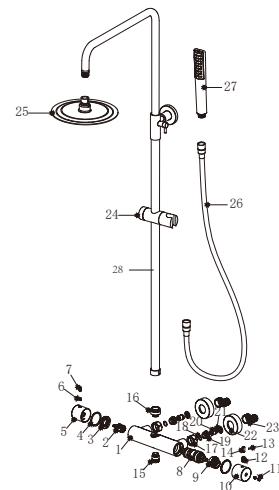

CODE	NAME	MATERIAL	REF	CODE	NAME	MATERIAL	REF
1	Body	Brass		16	Connect	Brass	
2	Cartridge	25mm up		17	Nut	Brass	
3	Nut	Brass		18	O-ring	NBR	
4	Washer	POM		19	Screw	SUS 304	
5	Handle lever	Zinc		20	Valve	ABS	
6	Screw	SUS 304		21	Rubber washer	NBR	
7	Handle lever	Brass		22	Cover	SUS 304	
8	Cartridge	32mm	CRT012*	23	Cabrio leg	SUS 304	
9	Washer	POM		24	Slider	SUS 304	RR0014*
10	Handle	Zinc		25	Shower head	SUS 304	RDN001*
11	Cover	ABS		26	Hose	SUS 304 / PVC	FLX002*
12	Spring	SUS 304		27	Shower hand	ABS	MDD010*
13	Pin	SUS 304		28	Pipe	SUS 304	
14	Handle lever	Brass					
15	Connect	Brass					

* CONSULTAR PARA ACABADOS DE COLOR

Installing instruction

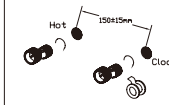

Step 1. Connect curved leg with the inlet pipe inside the wall

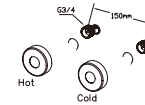

Step 2. Connect decorate cover to curved leg

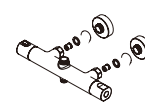

Step 3. Install shower faucet properly, and connect to curved leg on the wall

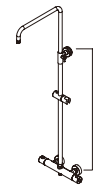

Step 4. Install shower pipe according to the distance of fix part

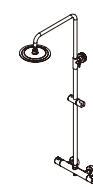

Step 5. Install shower hand and shower head to the set



Step 6. Test function of shower set, clean the set

Usage function instruction

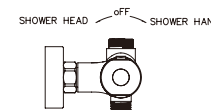
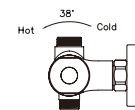

FLOW RATE

Detalles	
FLOW RATE REF	BTN047
hand shower mixer water 0.1Mpa(L/MIN)	5.77
hand shower mixer water 0.3Mpa(L/MIN)	10.57
hand shower mixer water 0.5Mpa(L/MIN)	14.24
hand shower singer cold water 0.1Mpa(L/MIN)	5.58
hand shower singer cold water 0.3Mpa(L/MIN)	10.12
hand shower singer cold water 0.5Mpa(L/MIN)	13.57
shower head mixer water 0.1Mpa(L/MIN)	8.43
shower head mixer water 0.3Mpa(L/MIN)	14.97
shower head mixer water 0.5Mpa(L/MIN)	19.57
shower head singer cold water 0.1Mpa(L/MIN)	7.77
shower head singer cold water 0.3Mpa(L/MIN)	13.7
shower head singer cold water 0.5Mpa(L/MIN)	17.8

hand shower

shower head

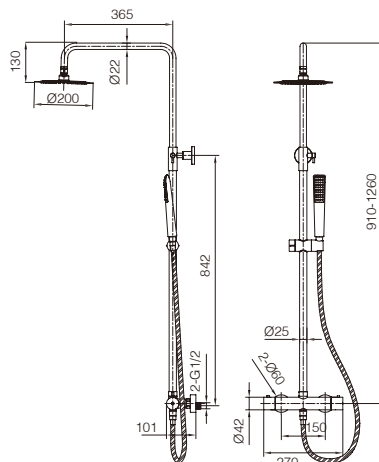
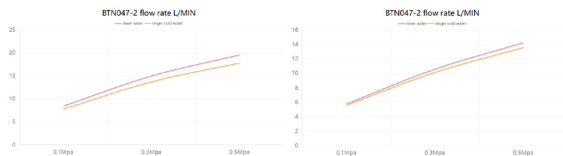

Product sizes (cm)	42.5*13.3*90
Weight (kg)	5.5
Guarantee	5 years
Max Preassure (bar)	5
Min Preassure (bar)	0.5
Optimum preassure (bar)	1-4 (Recommended 3)
Max. temperature	85°C
Min temperature	65°C

CERTIFIES

That all our products, provided that they are used in normal conditions or installed in accordance with current standards, are guaranteed against any manufacturing defect for a period of five years, except for products purchased before January 1, 2020, which will have the mand atory coverage of 2 years from the date of invoice.

Requirements and exclusions

Failure to comply with the instructions for assembly, use and maintenance of our products on the packaging and in our catalogue and published on our website: www.imexproducts.es, releases IMEX PRODUCTS, S.L. from any liability.

In any case, the acceptance of the defect by our technical department is necessary. In addition, transport costs will be charged only in the event that on IMEX PRODUCTS, S.L. technician determines the proper functioning of our products.

IMEX PRODUCTS, S.L. will decide to repair the product or replace it. It will be necessary to present the purchase invoice.

Assembly, maintenance or repairs carried out by non-specoalists re excluded from the warranty.

Wearing parts such as hoses, handles, seals, filters, aerators, etc. are not covered by the warranty.



**PRODUCT
INFORMATION
SUMMARY**



Ref.	EAN	Finish
GTN047	8435668044127	Chrome
GTN047-BGM	8435668044141	Black gun metal
GTN047-NG	8435668044165	Matte black
GTN047-ORC	8435668044202	Brushed rose gold
GTN047-OC	8435668044189	Brushed gold

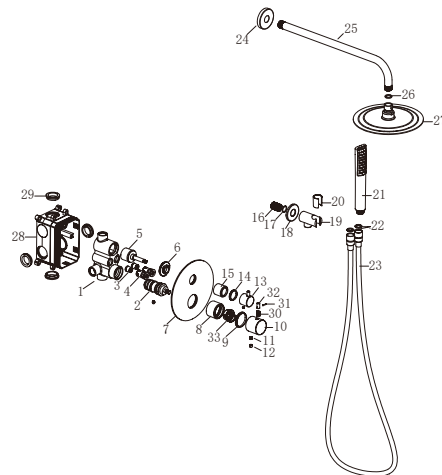

CODE	NAME	MATERIAL	REF	CODE	NAME	MATERIAL	REF
1	Body	Brass		20	Plastic washer	Plastic	
2	Cartridge	32mm	CRT012*	21	Shower	Plastic	MDD010*
3	Check valve	ASSY		22	Rubber ring	NBR	
4	Control valve	ASSY		23	Hose	PVC	FLX002*
5	cartridge	33mm up		24	Cover	SUS 304	
6	Nut	Brass		25	Hose	SUS 304	
7	Decorative plate	SUS 304		26	Rubber ring	NBR	
8	Cartridge cover	Brass		27	Shower head	SUS 304	RDN002*
9	Plastic washer	Plastic		28	BOX	ABS	
10	Handle	Zinc		29	Rubber ring	NBR	
11	Screw	SUS 304		30	Spring	SUS 304	
12	Button	ABS		31	Pin	SUS 304	
13	Handle	Zinc		32	Handle lever	Brass	
14	Plastic washer	Plastic		33	Washer	POM	
15	Cover	Brass					
16	Connect	Brass					
17	Oring	NBR					
18	Cover	Brass					
19	Body	Brass					

* CONSULTAR PARA ACABADOS DE COLOR

Installing instruction

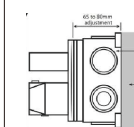

Step 1. Connect curved leg to the inlet pipe inside the wall



Step 2. Connect decorative cover to curved leg

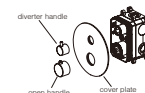

Step 3. Install shower faucet properly and connect to curved leg on the wall



Step 4. Install shower pipe according to the distance of fix part



Step 5. Install shower hand and shower head to the set



Step 6. Test function of shower set, clean the set

NAPLES

Series



FLOW RATE

Detalles	
FLOW RATE REF	GTN047
hand shower mixer water 0.1Mpa(L/MIN)	5.27
hand shower mixer water 0.3Mpa(L/MIN)	9.62
hand shower mixer water 0.5Mpa(L/MIN)	12.84
hand shower singer cold water 0.1Mpa(L/MIN)	4.95
hand shower singer cold water 0.3Mpa(L/MIN)	9.02
hand shower singer cold water 0.5Mpa(L/MIN)	11.95
shower head mixer water 0.1Mpa(L/MIN)	6.1
shower head mixer water 0.3Mpa(L/MIN)	11.16
shower head mixer water 0.5Mpa(L/MIN)	14.76
shower head singer cold water 0.1Mpa(L/MIN)	5.63
shower head singer cold water 0.3Mpa(L/MIN)	10.28
shower head singer cold water 0.5Mpa(L/MIN)	13.6

hand shower

shower head

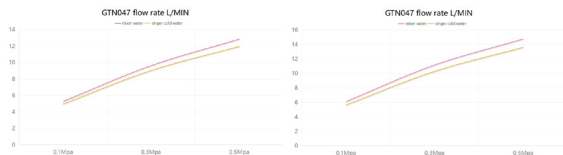

NAPLES

Series

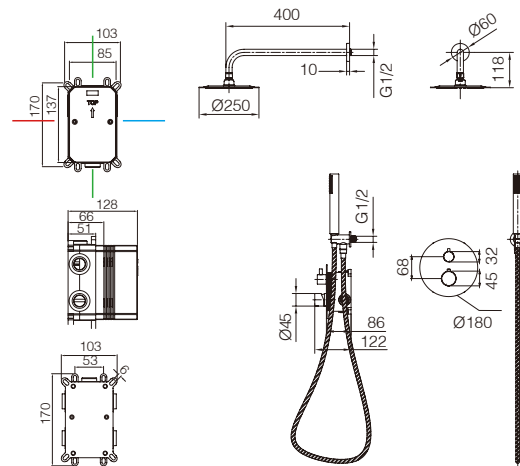

Product sizes (cm)	43*30*14
Weight (kg)	4.8
Guarantee	5 years
Max Preassure (bar)	5
Min Preassure (bar)	0.5
Optimum preassure (bar)	1-4 (Recommended 3)
Max. temperature	85°C
Min temperature	65°C

NAPLES

Series



CERTIFIES

That all our products, provided that they are used in normal conditions or installed in accordance with current standards, are guaranteed against any manufacturing defect for a period of five years, except for products purchased before January 1, 2020, which will have the mand atory coverage of 2 years from the date of invoice.

Requirements and exclusions

Failure to comply with the instructions for assembly, use and maintenance of our products on the packaging and in our catalogue and published on our website: www.imexproducts.es, releases IMEX PRODUCTS, S.L. from any liability.

In any case, the acceptance of the defect by our technical department is necessary. In addition, transport costs will be charged only in the event that on IMEX PRODUCTS, S.L. technician determines the proper functioning of our products.

IMEX PRODUCTS, S.L. will decide to repair the product or replace it. It will be necessary to present the purchase invoice.

Assembly, maintenance or repairs carried out by non-specoalists re excluded from the warranty.

Wearing parts such as hoses, handles, seals, filters, aerators, etc. are not covered by the warranty.



PRODUCT INFORMATION SUMMARY



Ref.	EAN	Finish
GLN047	8435668035293	Chrome
GLN047-BGM	8435668035309	Black gun metal
GLN047-NG	8435668035316	Matte black
GLN047-ORC	8435668035330	Brushed rose gold
GLN047-OC	8435668035323	Brushed gold

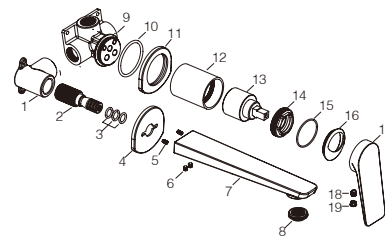

CODE	NAME	MATERIAL	REF
1	Connector	Brass	
2	Connector	Brass	
3	O-ring	NBR	
4	Base ring	Brass	
5	Screw	SUS 304	
6	Screw	SUS 304	
7	Spout	Brass	
8	Aerator	24x1mm	SAT-AIR072*
9	Boby	Brass	
10	O-ring	NBR	
11	Base ring	Brass	
12	Cartridge cover	Brass	
13	Cartridge	30mm	CRT027*
14	Nut	Brass	
15	O-ring	NBR	
16	Dcorative cup	Brass	
17	Handle	Zinc	
18	Screw	SUS304	
19	Button	ABS	

* CONSULTAR PARA ACABADOS DE COLOR

Installing instruction

FLOW RATE

Detalles	
FLOW RATE REF	GLN047
mixer water 0.1Mpa(L/MIN)	4.51
mixer water 0.3Mpa(L/MIN)	7.46
mixer water 0.5Mpa(L/MIN)	9.5
singer cold water 0.1Mpa(L/MIN)	4.48
singer cold water 0.3Mpa(L/MIN)	7.3
singer cold water 0.5Mpa(L/MIN)	9.4

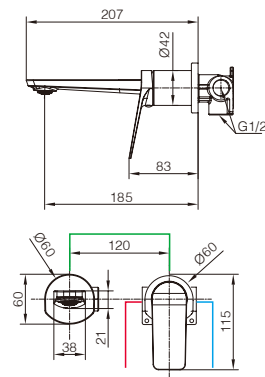

Product sizes (cm)	29*17,5*6.7
Weight (kg)	1.3
Guarantee	5 years
Max Preassure (bar)	5
Min Preassure (bar)	0.5
Optimum preassure (bar)	1-4 (Recommended 3)
Max. temperature	85°C
Min temperature	65°C

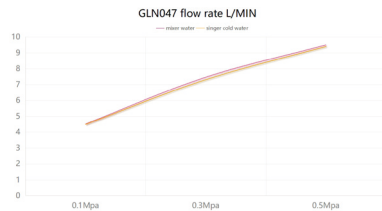

CERTIFIES

That all our products, provided that they are used in normal conditions or installed in accordance with current standards, are guaranteed against any manufacturing defect for a period of five years, except for products purchased before January 1, 2020, which will have the mand atory coverage of 2 years from the date of invoice.

Requirements and exclusions

Failure to comply with the instructions for assembly, use and maintenance of our products on the packaging and in our catalogue and published on our website: www.imexproducts.es, releases IMEX PRODUCTS, S.L. from any liability.

In any case, the acceptance of the defect by our technical department is necessary. In addition, transport costs will be charged only in the event that on IMEX PRODUCTS, S.L. technician determines the proper functioning of our products.

IMEX PRODUCTS, S.L. will decide to repair the product or replace it. It will be necessary to present the purchase invoice.

Assembly, maintenance or repairs carried out by non-specoalists re excluded from the warranty.

Wearing parts such as hoses, handles, seals, filters, aerators, etc. are not covered by the warranty.

