

# POOLIMEX

TEXAS  
Series

POOLIMEX

TEXAS  
Series

POOLIMEX

TEXAS  
Series

POOLIMEX

## PRODUCT INFORMATION SUMMARY



Ref.	EAN	Finish
GPT005/AC	8435668058636	ACERO S.316
GPT005/ANG	8435668058643	NEGRO MATE

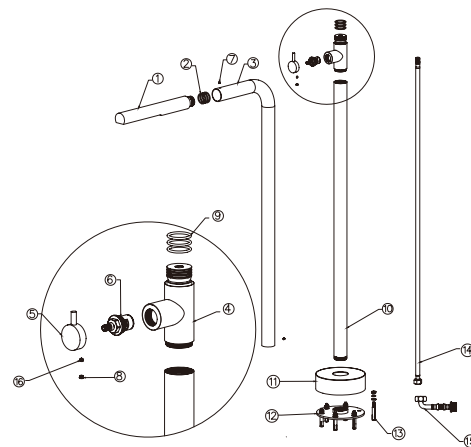

CODE	NAME	MATERIAL	REF
1	shower head	SUS 316	
2	29*3mm rubber	NBR	
3	upper pipe	SUS 316	
4	faucet body	SUS 316	
5	handle	SUS 316	
6	MINGRUI HQ2118 cartridge	assembly	Ø23.5MM
7	6mm*8mm screw	SUS 304	
8	color button	NBR	
9	28*3.5mm rubber	NBR	
10	down pipe	SUS 316	
11	Ø160mm cover plate(42mm hole)	SUS 316	
12	Ø152mm fixed seat(42mm hole)	SUS 316	
13	screw	SUS 304	
14	1.3m*Ø14mm G1/2 inlet pipe	SUS 316	
15	G1/2 elbow connection	SUS 316	
16	5mm*6mm screw	SUS 304	

\* CONSULTAR PARA ACABADOS DE COLOR

### Installing instruction

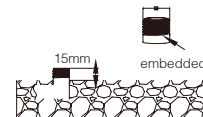

Step 1. Tuyau d'eau incorporé sous terre

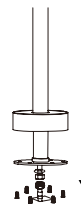

Step 2. Connectez the inlet pipe

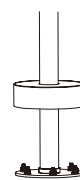

Step 3. Tightcn the screws

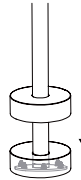

Step 4. Close the cover plate

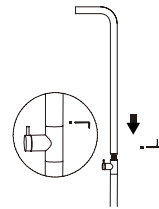

Step 5. Connectez the faucet body with the pips

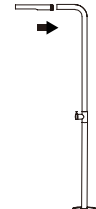

Step 6. Connectez the shower head

TEXAS

Series

POOLIMEX

## FLOW RATE

Detalles	
FLOW RATE REF	GPT005
Top shower 0.1Mpa(L/MIN)	6
Top shower 0.3Mpa(L/MIN)	15.8
Top shower 0.5Mpa(L/MIN)	22.1

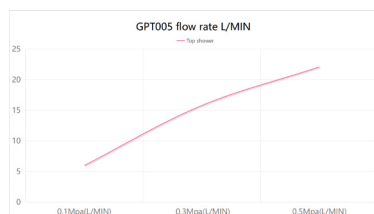

TEXAS

Series

POOLIMEX

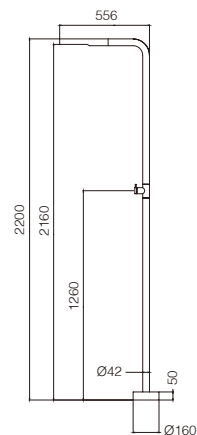

Product sizes (cm)	126.5*53.7*10.7
Weight (kg)	7.8
Guarantee	10 years
Max Preassure (bar)	8
Min Preassure (bar)	1
Optimum preassure (bar)	3-4
Max. temperature	55 °C
Min temperature	0 °C

TEXAS

Series

POOLIMEX

## CERTIFIES

That all our products, provided that they are used in normal conditions or installed in accordance with current standards, are guaranteed against any manufacturing defect for a period of five years, except for products purchased before January 1, 2020, which will have the mandatory coverage of 2 years from the date of invoice.

Requirements and exclusions

Failure to comply with the instructions for assembly, use and maintenance of our products on the packaging and in our catalogue and published on our website: [www.imexproducts.es](http://www.imexproducts.es), releases IMEX PRODUCTS, S.L. from any liability.

In any case, the acceptance of the defect by our technical department is necessary. In addition, transport costs will be charged only in the event that on IMEX PRODUCTS, S.L. technician determines the proper functioning of our products.

IMEX PRODUCTS, S.L. will decide to repair the product or replace it. It will be necessary to present the purchase invoice.

Assembly, maintenance or repairs carried out by non-specialists are excluded from the warranty.

Wearing parts such as hoses, handles, seals, filters, aerators, etc. are not covered by the warranty.

