

POOLIMEX

COLORADO

Series

POOLIMEX

COLORADO

Series

POOLIMEX

COLORADO

Series

POOLIMEX

PRODUCT INFORMATION SUMMARY

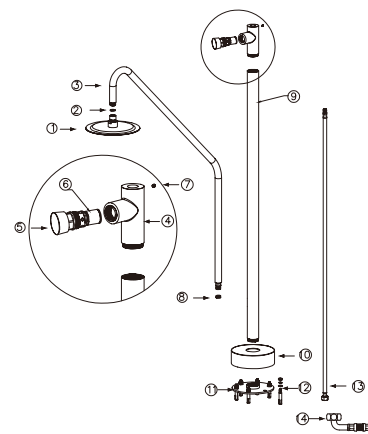

Ref.	EAN	Finish
GPC004/AC	8435668058629	ACERO S.316

CODE	NAME	MATERIAL	REF
1	Ø250mm,G1/2 shower head	SUS 316	
2	G1/2 rubber	NBR	
3	upper pipe	SUS 316	
4	faucet body	SUS 316	
5	handle	SUS 316	
6	cartridge	assembly	Ø23.5MM
7	6mm*8mm screw	SUS 304	
8	17*3.5mm rubber	NBR	
9	down pipe	SUS 316	
10	Ø160mm cover plate(42mm hole)	SUS 316	
11	Ø152mm fixed seat(42mm hole)	SUS 316	
12	screw	SUS 304	
13	1.3m*Ø14mm G1/2 inlet pipe	SUS 316	
14	G1/2 elbow connection	SUS 316	

* CONSULTAR PARA ACABADOS DE COLOR

Installing instruction

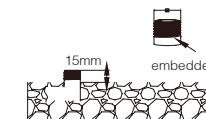

Step 1.Embedd water pipe underground

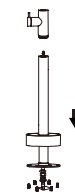

Step 2.Connect the inlet pipe

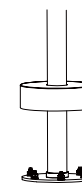

Step 3.Tighten the screws

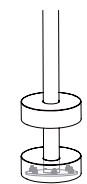

Step 4.Close the cover

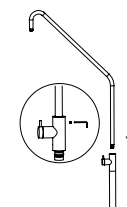

Step 5.Connect the faucet body with the pipes

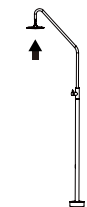

Step 6.Connect the shower head

COLORADO

POOLIMEX

Series

FLOW RATE

Detalles	
FLOW RATE REF	GPC004
Top shower 0.1Mpa(L/MIN)	4.1
Top shower 0.3Mpa(L/MIN)	11.8
Top shower 0.5Mpa(L/MIN)	16.7

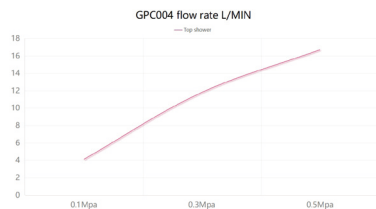

COLORADO

POOLIMEX

Series

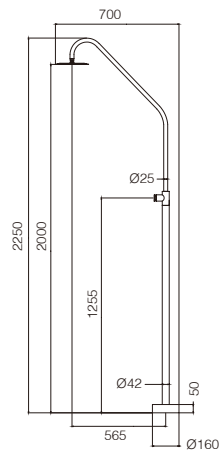

Product sizes (cm)	126.5*53.7*10.7
Weight (kg)	7.8
Guarantee	10 years
Max Preassure (bar)	8
Min Preassure (bar)	1
Optimum preassure (bar)	3-4
Max. temperature	55 °C
Min temperature	0 °C

COLORADO

POOLIMEX

Series

CERTIFIES

That all our products, provided that they are used in normal conditions or installed in accordance with current standards, are guaranteed against any manufacturing defect for a period of five years, except for products purchased before January 1, 2020, which will have the mandatory coverage of 2 years from the date of invoice.

Requirements and exclusions

Failure to comply with the instructions for assembly, use and maintenance of our products on the packaging and in our catalogue and published on our website: www.imexproducts.es, releases IMEX PRODUCTS, S.L. from any liability.

In any case, the acceptance of the defect by our technical department is necessary. In addition, transport costs will be charged only in the event that on IMEX PRODUCTS, S.L. technician determines the proper functioning of our products.

IMEX PRODUCTS, S.L. will decide to repair the product or replace it. It will be necessary to present the purchase invoice.

Assembly, maintenance or repairs carried out by non-specialists are excluded from the warranty.

Wearing parts such as hoses, handles, seals, filters, aerators, etc. are not covered by the warranty.

