

**PRODUCT
INFORMATION
SUMMARY**

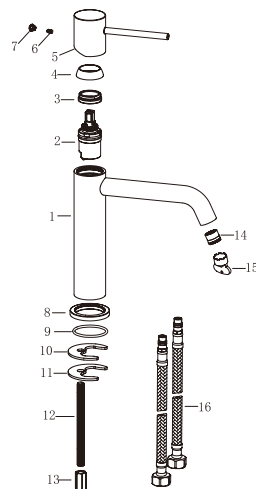

Ref.	EAN	Finish
BDM039-1	8435668030717	Chrome
BDM039-1BGM	8435668030724	Black gun metal
BDM039-1NG	8435668030731	Matte black
BDM039-1ORC	8435668030755	Brushed rose gold
BDM039-1OC	8435668030748	Brushed gold
BDM039-1NQ	8435668056489	Brushed nickel



CODE	NAME	MATERIAL	REF
1	Main body	brass	
2	Cartridge	26mmup	CRT007*
3	Cartridge cover	brass	
4	Decorative cover	ABS	
5	handle	Zinc	
6	screw	SUS 304/5x5mm	
7	Button	ABS	
8	base	brass	
9	O-ring	NBR	
10	Rubber washer	NBR	
11	Metal washer	SS 304	
12	M8-Screw	SS 304	
13	M8-Nut	brass	
14	Aerator	ABS/M16.5x1mm	SAT-AIR060*
15	Aerator spanner	plastic	SAT-KEY*
16	Connecting Pipe	TAQ-PEX-DN6-ACB H3/8-M10X1 L12-500-R&B	SAT-HOSES7*

* CONSULTAR PARA ACABADOS DE COLOR

Installing instruction

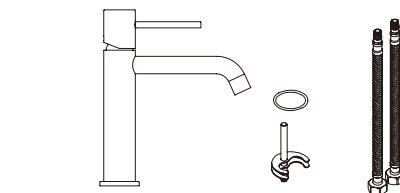

Step 1. Check all spare parts ready

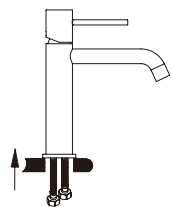

Step 2. Install inlet pipe to faucet body

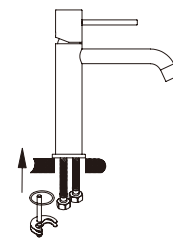

Step 3. Install screw stick to faucet body

Usage function instruction

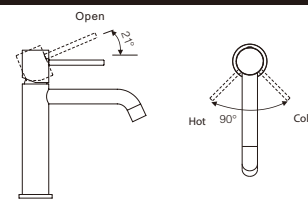

FLOW RATE

Detalles	
FLOW RATE REF	BDM039-1
mixer water 0.1Mpa(L/MIN)	4.74
mixer water 0.3Mpa(L/MIN)	8.16
mixer water 0.5Mpa(L/MIN)	10.52
singer cold water 0.1Mpa(L/MIN)	4.25
singer cold water 0.3Mpa(L/MIN)	7.38
singer cold water 0.5Mpa(L/MIN)	9.47

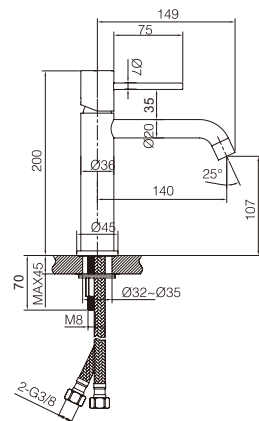
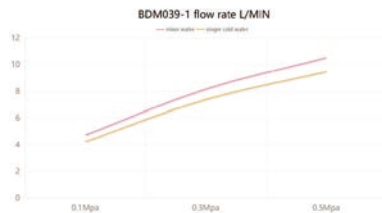

Product sizes (cm)	30*21*5.9
Weight (kg)	0.935
Guarantee	5 years
Max Preasure (bar)	5
Min Preasure (bar)	0.5
Optimum preasure (bar)	1-4 (Recommended 3)
Max. temperature	85°C
Min temperature	65°C

CERTIFIES

That all our products, provided that they are used in normal conditions or installed in accordance with current standards, are guaranteed against any manufacturing defect for a period of five years, except for products purchased before January 1, 2020, which will have the mandatory coverage of 2 years from the date of invoice.

Requirements and exclusions

Failure to comply with the instructions for assembly, use and maintenance of our products on the packaging and in our catalogue and published on our website: www.imexproducts.es, releases IMEX PRODUCTS, S.L. from any liability.

In any case, the acceptance of the defect by our technical department is necessary. In addition, transport costs will be charged only in the event that on IMEX PRODUCTS, S.L. technician determines the proper functioning of our products.

IMEX PRODUCTS, S.L. will decide to repair the product or replace it. It will be necessary to present the purchase invoice.

Assembly, maintenance or repairs carried out by non-specialists are excluded from the warranty.

Wearing parts such as hoses, handles, seals, filters, aerators, etc. are not covered by the warranty.



**PRODUCT
INFORMATION
SUMMARY**



Ref.	EAN	Finish
BDM039-2	8435668030465	Chrome
BDM039-2BGM	8435668030472	Black gun metal
BDM039-2NG	8435668030489	Matte black
BDM039-2ORC	8435668030502	Brushed rose gold
BDM039-2OC	8435668030496	Brushed gold
BDM039-2NQ	8435668056502	Brushed nickel

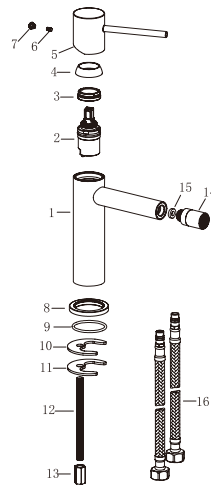

CODE	NAME	MATERIAL	REF
1	Main body	brass	
2	Cartridge	26mm up	CRT007*
3	Cartridge cover	brass	
4	Decorative cover	ABS	
5	handle	Zinc	
6	screw	SU5 304/5x5mm	
7	Button	ABS	
8	base	brass	
9	O-ring	NBR	
10	Rubber washer	NBR	
11	Metal washer	SS 304	
12	M8-Screw	SS 304	
13	M8-Nut	brass	
14	Aerator	ABS/16mm	SAT-AIR* SAT-KEY*
15	Washer	NBR	SAT-KEY*
16	Connecting Pipe	TAQ-PEX-DN6-ACB H3/8-M10X1 L12-500-R&B	SAT-HOSES7*

* CONSULTAR PARA ACABADOS DE COLOR

Installing instruction

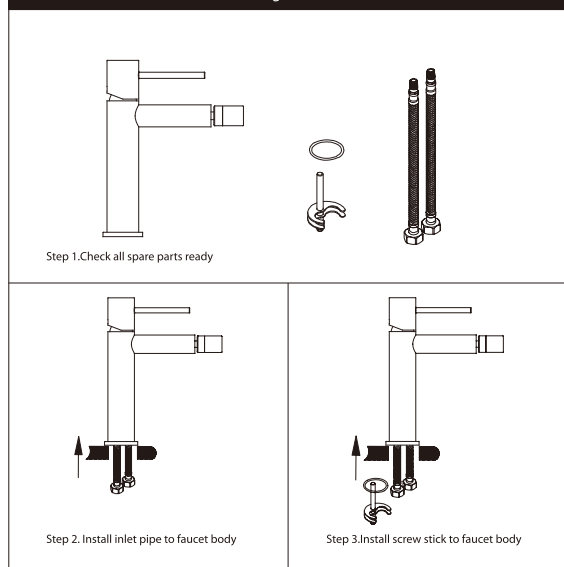

Usage function instruction

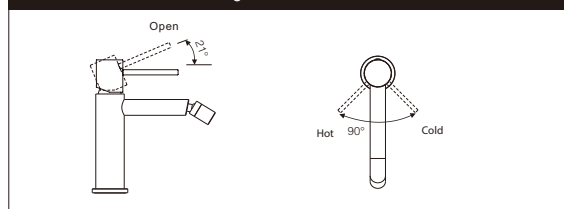

FLOW RATE

Detalles	
FLOW RATE REF	BDM039-2
mixer water 0.1Mpa(L/MIN)	4.26
mixer water 0.3Mpa(L/MIN)	7.35
mixer water 0.5Mpa(L/MIN)	9.54
singer cold water 0.1Mpa(L/MIN)	4.22
singer cold water 0.3Mpa(L/MIN)	7.22
singer cold water 0.5Mpa(L/MIN)	9.37

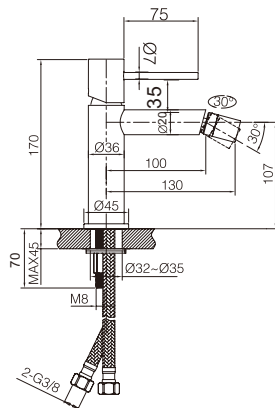
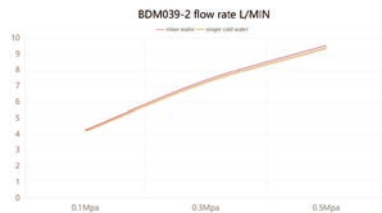

Product sizes (cm)	26.7*18.1*5.9
Weight (kg)	0.885
Guarantee	5 years
Max Preasure (bar)	5
Min Preasure (bar)	0.5
Optimum preasure (bar)	1-4 (Recommended 3)
Max. temperature	85°C
Min temperature	65°C

CERTIFIES

That all our products, provided that they are used in normal conditions or installed in accordance with current standards, are guaranteed against any manufacturing defect for a period of five years, except for products purchased before January 1, 2020, which will have the mandatory coverage of 2 years from the date of invoice.

Requirements and exclusions

Failure to comply with the instructions for assembly, use and maintenance of our products on the packaging and in our catalogue and published on our website: www.imexproducts.es, releases IMEX PRODUCTS, S.L. from any liability.

In any case, the acceptance of the defect by our technical department is necessary. In addition, transport costs will be charged only in the event that on IMEX PRODUCTS, S.L. technician determines the proper functioning of our products.

IMEX PRODUCTS, S.L. will decide to repair the product or replace it. It will be necessary to present the purchase invoice.

Assembly, maintenance or repairs carried out by non-specialists are excluded from the warranty.

Wearing parts such as hoses, handles, seals, filters, aerators, etc. are not covered by the warranty.



**PRODUCT
INFORMATION
SUMMARY**



Ref.	EAN	Finish
BDM039-3	8435668030618	Chrome
BDM039-3BGM	8435668030625	Black gun metal
BDM039-3NG	8435668030632	Matte black
BDM039-3ORC	8435668030656	Brushed rose gold
BDM039-3OC	8435668030649	Brushed gold
BDM039-3NQ	8435668056526	Brushed nickel

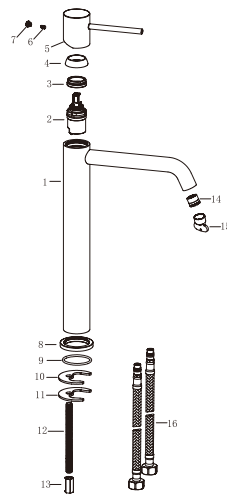

CODE	NAME	MATERIAL	REF
1	Main body	brass	
2	Cartridge	26mm up	CRT007*
3	Cartridge cover	brass	
4	Decorative cover	ABS	
5	Handle	Zinc	
6	screw	SUS 304/5x5mm	
7	Button	ABS	
8	base	brass	
9	O-ring	NBR	
10	Rubber washer	NBR	
11	Metal washer	SS 304	
12	M8-Screw	SS 304	
13	M8-Nut	brass	
14	Aerator	ABS/M16.5x1mm	SAT-AIR060*
15	Aerator spanner	ABS/16.5mm	SAT-KEY*
16	Connecting Pipe	TAQ-PEX-DN6-ACB H3/8-M10X1 L12-500-R&B	SAT-HOSES7*

* CONSULTAR PARA ACABADOS DE COLOR

Installing instruction

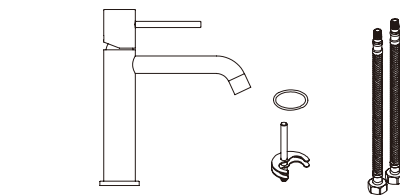

Step 1. Check all spare parts ready

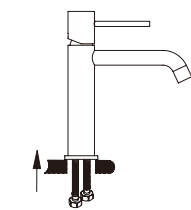

Step 2. Install inlet pipe to faucet body

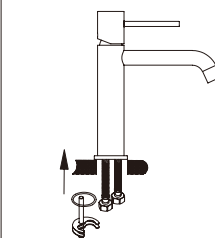

Step 3. Install screw stick to faucet body

Usage function instruction

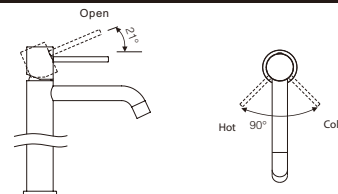

FLOW RATE

Detalles

FLOW RATE REF	BDM039-3
mixer water 0.1Mpa(L/MIN)	5
mixer water 0.3Mpa(L/MIN)	8.55
mixer water 0.5Mpa(L/MIN)	11.04
singer cold water 0.1Mpa(L/MIN)	4.69
singer cold water 0.3Mpa(L/MIN)	8.08
singer cold water 0.5Mpa(L/MIN)	10.41

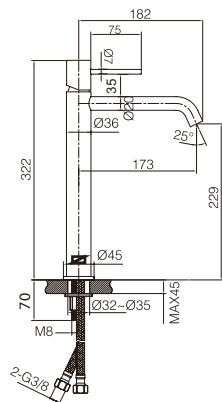
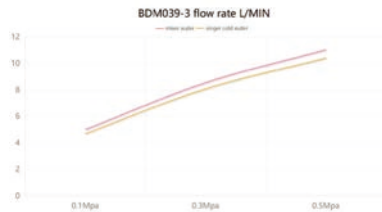

Product sizes (cm)	39*21*5.9
Weight (kg)	1.153
Guarantee	5 years
Max Preasure (bar)	5
Min Preasure (bar)	0.5
Optimum preasure (bar)	1-4 (Recommended 3)
Max. temperature	85°C
Min temperature	65°C

CERTIFIES

That all our products, provided that they are used in normal conditions or installed in accordance with current standards, are guaranteed against any manufacturing defect for a period of five years, except for products purchased before January 1, 2020, which will have the mandatory coverage of 2 years from the date of invoice.

Requirements and exclusions

Failure to comply with the instructions for assembly, use and maintenance of our products on the packaging and in our catalogue and published on our website: www.imexproducts.es, releases IMEX PRODUCTS, S.L. from any liability.

In any case, the acceptance of the defect by our technical department is necessary. In addition, transport costs will be charged only in the event that on IMEX PRODUCTS, S.L. technician determines the proper functioning of our products.

IMEX PRODUCTS, S.L. will decide to repair the product or replace it. It will be necessary to present the purchase invoice.

Assembly, maintenance or repairs carried out by non-specialists are excluded from the warranty.

Wearing parts such as hoses, handles, seals, filters, aerators, etc. are not covered by the warranty.



**PRODUCT
INFORMATION
SUMMARY**



Ref.	EAN	Finish
BDM039-4	8435668030519	Chrome
BDM039-4BGM	8435668030526	Black gun metal
BDM039-4NG	8435668030533	Matte black
BDM039-4ORC	8435668030557	Brushed rose gold
BDM039-4OC	8435668030540	Brushed gold
BDM039-4NQ	8435668056540	Brushed nickel

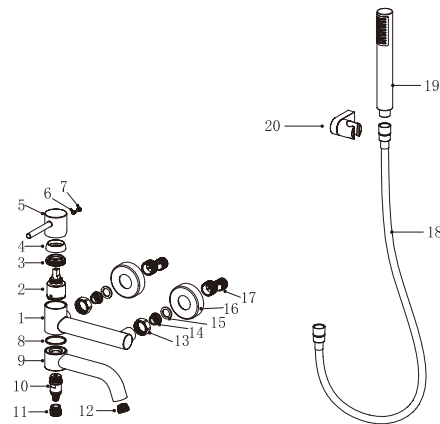

CODE	NAME	MATERIAL	REF
1	Body	Brass	
2	Cartridge	35mm	CRT006*
3	Nut	Brass	
4	Cover	ABS	
5	Handle	Zinc	
6	Screw	SUS 304	
7	Cover	ABS	
8	Washer	POM	
9	Outlet pipe	Brass	
10	Cartridge	Brass/24mm	
11	Connector	Brass	
12	Aerator	ABS/M18.5x1mm	SAT-AIR018*
13	Nut	Brass	
14	Valve	SUS 304	
15	Rubber washer	NBR	
16	Cover	SUS 304	
17	Cabrio leg	SUS 304	
18	Hose	PVC	FLX010*
19	Shower hand	ABS	MDR015*
20	Shower base	ABS	SMD007*

* CONSULTAR PARA ACABADOS DE COLOR

Installing instruction

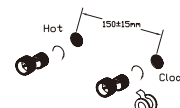

Step 1. Connect curved leg with the inlet pipe inside the wall

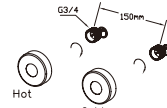

Step 2. Connect decorative cover to curved leg



Step 3. Install shower faucet properly, and connect to curved leg on the wall



Step 4. Test function of shower set, clean the set

Usage function instruction

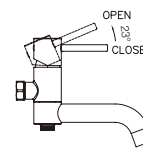
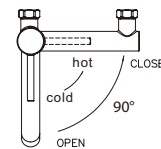

FLOW RATE

Detalles	
FLOW RATE REF	BDM039-4
water outlet mixer water 0.1Mpa(L/MIN)	7.41
water outlet mixer water 0.3Mpa(L/MIN)	13.33
water outlet mixer water 0.5Mpa(L/MIN)	16.38
water outlet singer cold water 0.1Mpa(L/MIN)	6.89
water outlet singer cold water 0.3Mpa(L/MIN)	11.79
water outlet singer cold water 0.5Mpa(L/MIN)	15.2
hand shower mixer water 0.1Mpa(L/MIN)	5.76
hand shower mixer water 0.3Mpa(L/MIN)	10.38
hand shower mixer water 0.5Mpa(L/MIN)	13.86
hand shower singer cold water 0.1Mpa(L/MIN)	5.46
hand shower singer cold water 0.3Mpa(L/MIN)	9.83
hand shower singer cold water 0.5Mpa(L/MIN)	13.07

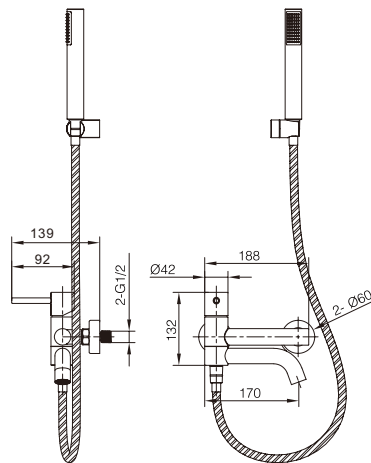
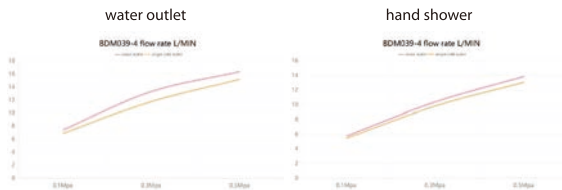

Product sizes (cm)	28*16*12.2
Weight (kg)	1.85
Guarantee	5 years
Max Preassure (bar)	5
Min Preassure (bar)	0.5
Optimum preassure (bar)	1-4 (Recommended 3)
Max. temperature	85°C
Min temperature	65°C

CERTIFIES

That all our products, provided that they are used in normal conditions or installed in accordance with current standards, are guaranteed against any manufacturing defect for a period of five years, except for products purchased before January 1, 2020, which will have the mandatory coverage of 2 years from the date of invoice.

Requirements and exclusions

Failure to comply with the instructions for assembly, use and maintenance of our products on the packaging and in our catalogue and published on our website: www.imexproducts.es, releases IMEX PRODUCTS, S.L. from any liability.

In any case, the acceptance of the defect by our technical department is necessary. In addition, transport costs will be charged only in the event that on IMEX PRODUCTS, S.L. technician determines the proper functioning of our products.

IMEX PRODUCTS, S.L. will decide to repair the product or replace it. It will be necessary to present the purchase invoice.

Assembly, maintenance or repairs carried out by non-specialists are excluded from the warranty.

Wearing parts such as hoses, handles, seals, filters, aerators, etc. are not covered by the warranty.



**PRODUCT
INFORMATION
SUMMARY**



Ref.	EAN	Finish
BTM039-4	8435668038041	Chrome
BTM039-4BGM	8435668038058	Black gun metal
BTM039-4NG	8435668038065	Matte black
BTM039-4ORC	8435668038089	Brushed rose gold
BTM039-4OC	8435668038072	Brushed gold
BTM039-4NQ	8435668056595	Brushed nickel

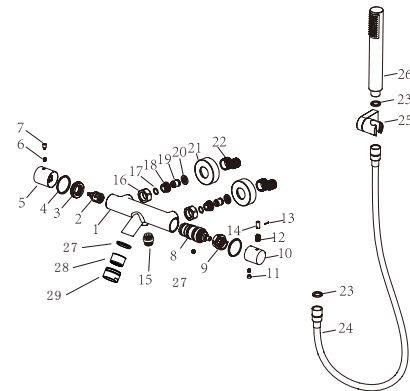

CODE	NAME	MATERIAL	REF	CODE	NAME	MATERIAL	REF
1	Body	Brass	20	20	Rubber washer	NBR	
2	Cartridge	25mm up	21	21	Cover	SUS 304	
3	Nut	Brass	22	22	Cabrio leg	SUS 304	
4	Washer	POM	23	23	Rubber washer	NBR	
5	Handle	Zinc	24	24	Hose	PVC	FLX010*
6	Screw	SUS 304	25	25	Shower seat	ABS	SMD007*
7	Handle lever	Brass	26	26	Shower hand	ABS	MDR015*
8	Cartridge	32mm	27	27	Rubber washer	NBR	
9	Washer	POM	28	28	Aerator	24mm	
10	Handle	Zinc	29	29	percolator	SUS 304	
11	Cover	ABS					
12	Spring	SUS 304					
13	Pin	SUS 304					
14	Handle lever	Brass					
15	Connect	Brass					
16	Nut	Brass					
17	O-ring	NBR					
18	Screw	SUS 304					
19	Valve	ABS					

* CONSULTAR PARA ACABADOS DE COLOR

Installing instruction



Step 1. Connect curved leg with the inlet pipe inside the wall

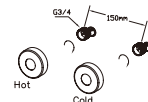

Step 2. Connect decorative cover to curved leg



Step 3. Install shower faucet properly, and connect to curved leg on the wall



Step 4. Test function of shower set, clean the set

Usage function instruction

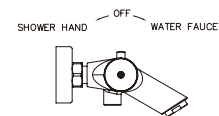
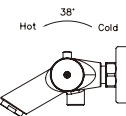

FLOW RATE

Detalles	
FLOW RATE REF	BTM039-4
water outlet mixer water 0.1Mpa(L/MIN)	10.48
water outlet mixer water 0.3Mpa(L/MIN)	18.37
water outlet mixer water 0.5Mpa(L/MIN)	24.02
water outlet singer cold water 0.1Mpa(L/MIN)	9.65
water outlet singer cold water 0.3Mpa(L/MIN)	17.04
water outlet singer cold water 0.5Mpa(L/MIN)	22.2
hand shower mixer water 0.1Mpa(L/MIN)	6.05
hand shower mixer water 0.3Mpa(L/MIN)	11.24
hand shower mixer water 0.5Mpa(L/MIN)	15.2
hand shower singer cold water 0.1Mpa(L/MIN)	5.82
hand shower singer cold water 0.3Mpa(L/MIN)	10.8
hand shower singer cold water 0.5Mpa(L/MIN)	14.6

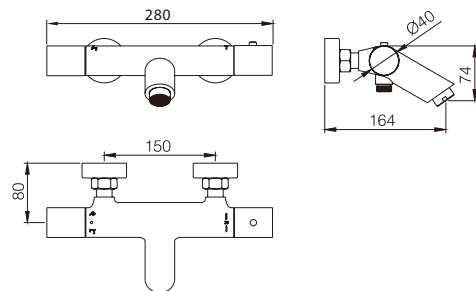

Product sizes (cm)	33*19.5*10.5
Weight (kg)	2.6
Guarantee	5 years
Max Preassure (bar)	5
Min Preassure (bar)	0.5
Optimum preassure (bar)	1-4 (Recommended 3)
Max. temperature	85°C
Min temperature	65°C

water outlet

hand shower

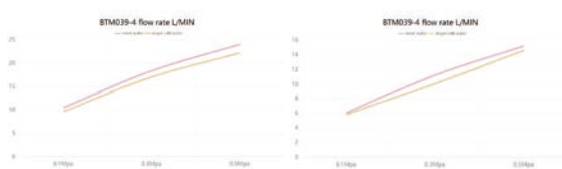

CERTIFIES

That all our products, provided that they are used in normal conditions or installed in accordance with current standards, are guaranteed against any manufacturing defect for a period of five years, except for products purchased before January 1, 2020, which will have the mandatory coverage of 2 years from the date of invoice.

Requirements and exclusions

Failure to comply with the instructions for assembly, use and maintenance of our products on the packaging and in our catalogue and published on our website: www.imexproducts.es, releases IMEX PRODUCTS, S.L. from any liability.

In any case, the acceptance of the defect by our technical department is necessary. In addition, transport costs will be charged only in the event that on IMEX PRODUCTS, S.L. technician determines the proper functioning of our products.

IMEX PRODUCTS, S.L. will decide to repair the product or replace it. It will be necessary to present the purchase invoice.

Assembly, maintenance or repairs carried out by non-specialists are excluded from the warranty.

Wearing parts such as hoses, handles, seals, filters, aerators, etc. are not covered by the warranty.



**PRODUCT
INFORMATION
SUMMARY**



Ref.	EAN	Finish
BDM039-5	8435668030564	Chrome
BDM039-5BGM	8435668030571	Black gun metal
BDM039-5NG	8435668030588	Matte black
BDM039-5ORC	8435668030601	Brushed rose gold
BDM039-5OC	8435668030595	Brushed gold
BDM039-5NQ	8435668056564	Brushed nickel

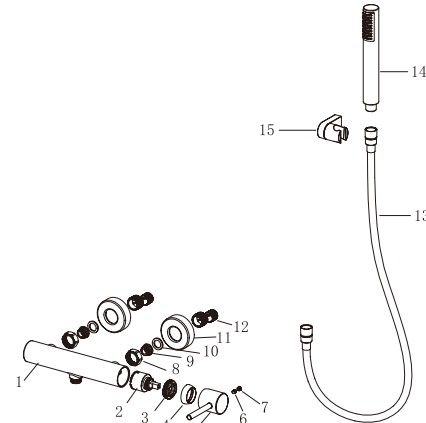

CODE	NAME	MATERIAL	REF
1	Body	Brass	
2	Cartridge	35mm	CRT006*
3	Nut	Brass	
4	Cover	ABS	
5	Handle	Zinc	
6	Screw	SUS 304	
7	Cover	ABS	
8	Nut	Brass	
9	Valve	SUS 304	
10	Rubber washer	NBR	
11	Connector	SUS 304	
12	Cabrio leg	SUS 304	
13	Hose	PVC	FLX010*
14	Shower hand	ABS	MDR015*
15	Shower base	ABS	SMD007*

* CONSULTAR PARA ACABADOS DE COLOR

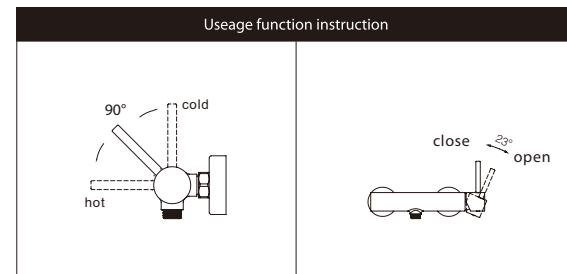
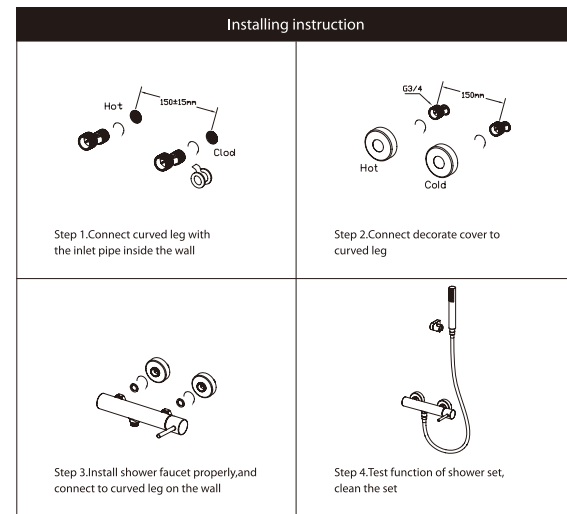

FLOW RATE

Detalles	
FLOW RATE REF	BDM039-5
mixer water 0.1Mpa(L/MIN)	6.37
mixer water 0.3Mpa(L/MIN)	11.76
mixer water 0.5Mpa(L/MIN)	15.9
singer cold water 0.1Mpa(L/MIN)	6.36
singer cold water 0.3Mpa(L/MIN)	11.58
singer cold water 0.5Mpa(L/MIN)	15.7

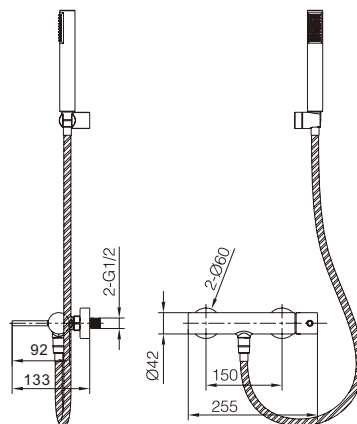
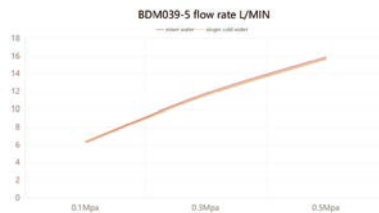

Product sizes (cm)	28*16*12.2
Weight (kg)	1.95
Guarantee	5 years
Max Preassure (bar)	5
Min Preassure (bar)	0.5
Optimum preassure (bar)	1-4 (Recommended 3)
Max. temperature	85°C
Min temperature	65°C

CERTIFIES

That all our products, provided that they are used in normal conditions or installed in accordance with current standards, are guaranteed against any manufacturing defect for a period of five years, except for products purchased before January 1, 2020, which will have the mandatory coverage of 2 years from the date of invoice.

Requirements and exclusions

Failure to comply with the instructions for assembly, use and maintenance of our products on the packaging and in our catalogue and published on our website: www.imexproducts.es, releases IMEX PRODUCTS, S.L. from any liability.

In any case, the acceptance of the defect by our technical department is necessary. In addition, transport costs will be charged only in the event that on IMEX PRODUCTS, S.L. technician determines the proper functioning of our products.

IMEX PRODUCTS, S.L. will decide to repair the product or replace it. It will be necessary to present the purchase invoice.

Assembly, maintenance or repairs carried out by non-specialists are excluded from the warranty.

Wearing parts such as hoses, handles, seals, filters, aerators, etc. are not covered by the warranty.



**PRODUCT
INFORMATION
SUMMARY**



Ref.	EAN	Finish
BTM039-5	8435668038096	Chrome
BTM039-5BGM	8435668038102	Black gun metal
BTM039-5NG	8435668038119	Matte black
BTM039-5ORC	8435668038133	Brushed rose gold
BTM039-5OC	8435668038126	Brushed gold
BTM039-5NQ	8435668056601	Brushed nickel

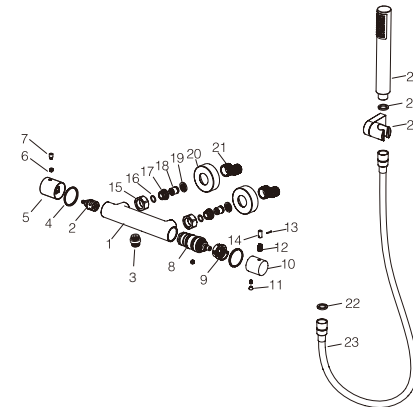

CODE	NAME	MATERIAL	REF	CODE	NAME	MATERIAL	REF
1	Body	Brass		20	Cover	SUS 304	
2	Cartridge	21mm	???	21	Cabrio leg	SUS 304	
3	Connect	Brass		22	Rubber washer	NBR	
4	Washer	POM		23	Hose	PVC	FLX010*
5	Handle	Zinc		24	Shower seat	ABS	SMD007*
6	Screw	SUS 304		25	Shower hand	ABS	MDR015*
7	Handle lever	Brass					
8	Cartridge	32mm	CRT012*				
9	Washer	POM					
10	Handle	Zinc					
11	Cover	ABS					
12	Spring	SUS 304					
13	Pin	SUS 304					
14	Handle lever	Brass					
15	Nut	Brass					
16	O-ring	NBR					
17	Screw	SUS 304					
18	Valve	ABS					
19	Rubber washer	NBR					

* CONSULTAR PARA ACABADOS DE COLOR

Installing instruction

Step 1. Connect curved leg with the inlet pipe inside the wall

Step 2. Connect decorative cover to curved leg

Step 3. Install shower faucet properly, and connect to curved leg on the wall

Step 4. Test function of shower set, clean the set

Usage function instruction

Hot 38° Cold

open 90° close

FLOW RATE

Detalles	
FLOW RATE REF	BTM039-5
mixer water 0.1Mpa(L/MIN)	5.71
mixer water 0.3Mpa(L/MIN)	10.44
mixer water 0.5Mpa(L/MIN)	14.1
singer cold water 0.1Mpa(L/MIN)	5.68
singer cold water 0.3Mpa(L/MIN)	10.39
singer cold water 0.5Mpa(L/MIN)	13.96

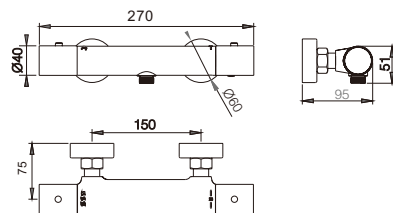
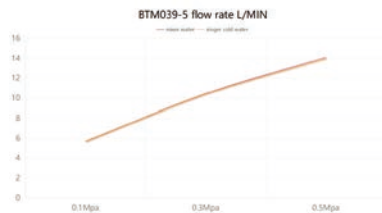

Product sizes (cm)	33*19.5*10.5
Weight (kg)	2.2
Guarantee	5 years
Max Preassure (bar)	5
Min Preassure (bar)	0.5
Optimum preassure (bar)	1-4 (Recommended 3)
Max. temperature	85°C
Min temperature	65°C

CERTIFIES

That all our products, provided that they are used in normal conditions or installed in accordance with current standards, are guaranteed against any manufacturing defect for a period of five years, except for products purchased before January 1, 2020, which will have the mandatory coverage of 2 years from the date of invoice.

Requirements and exclusions

Failure to comply with the instructions for assembly, use and maintenance of our products on the packaging and in our catalogue and published on our website: www.imexproducts.es, releases IMEX PRODUCTS, S.L. from any liability.

In any case, the acceptance of the defect by our technical department is necessary. In addition, transport costs will be charged only in the event that on IMEX PRODUCTS, S.L. technician determines the proper functioning of our products.

IMEX PRODUCTS, S.L. will decide to repair the product or replace it. It will be necessary to present the purchase invoice.

Assembly, maintenance or repairs carried out by non-specialists are excluded from the warranty.

Wearing parts such as hoses, handles, seals, filters, aerators, etc. are not covered by the warranty.



PRODUCT INFORMATION SUMMARY



Ref.	EAN	Finish
GPM039	8435668030106	Chrome
GPM039-BGM	8435668030113	Black gun metal
GPM039-NG	8435668030120	Matte black
GPM039-ORC	8435668030144	Brushed rose gold
GPM039-OC	8435668030137	Brushed gold
GPM039-NQ	8435668056632	Brushed nickel

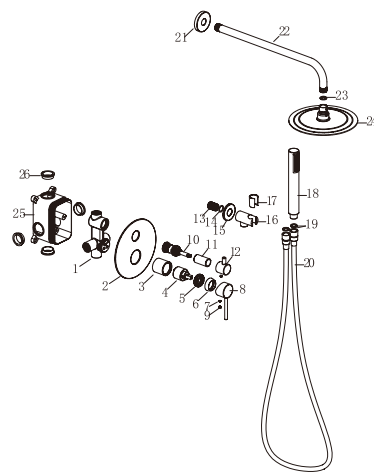

CODE	NAME	MATERIAL	REF	CODE	NAME	MATERIAL	REF
1	Body	Brass		20	Hose	PVC	FLX002*
2	Decorative plate	SUS 304		21	Cover	SUS 304	
3	Cartridge cover	Brass		22	Hose	SUS 304	BPR001*
4	Cartridge	35mm	CRT006*	23	Rubber ring	NBR	
5	Nut	Brass		24	Shower head	SUS 304	RDN002*
6	Decorative cup	ABS		25	BOX	ABS	
7	Screw	SUS 304		26	Rubber ring	NBR	
8	Handle	Zinc					
9	Button	ABS					
10	Cartridge	Brass/27mm	CRT060*				
11	Cover	Brass					
12	Handle	Zinc					
13	Connect	Brass					
14	O-ring	NBR					
15	Cover	Brass					
16	Body	Brass					
17	Plastic washer	Plastic					
18	Shower	Plastic	MDR015*				
19	Rubber ring	NBR					

* CONSULTAR PARA ACABADOS DE COLOR

Installing instruction

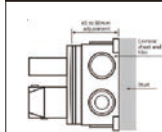

Step 1. Connect curved leg with the inlet pipe inside the wall



Step 2. Connect decorative cover to curved leg

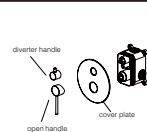

Step 3. Install shower faucet properly, and connect to curved leg on the wall

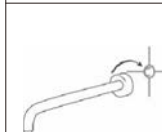

Step 4. Install shower pipe according to the distance of fix part



Step 5. Install shower hand and shower head to the set

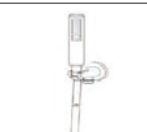

Step 6. Test function of shower set, clean the set

Usage function instruction

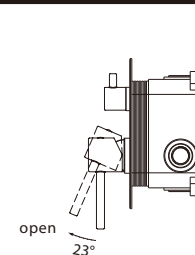
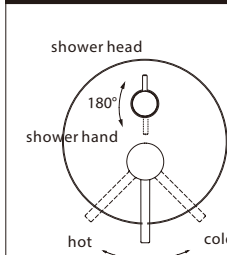

FLOW RATE

Detailles	
FLOW RATE REF	GPM039
hand shower mixer water 0.1Mpa(L/MIN)	5.85
hand shower mixer water 0.3Mpa(L/MIN)	10.74
hand shower mixer water 0.5Mpa(L/MIN)	14.43
hand shower singer cold water 0.1Mpa(L/MIN)	5.55
hand shower singer cold water 0.3Mpa(L/MIN)	10.05
hand shower singer cold water 0.5Mpa(L/MIN)	13.48
shower head mixer water 0.1Mpa(L/MIN)	5.87
shower head mixer water 0.3Mpa(L/MIN)	12.34
shower head mixer water 0.5Mpa(L/MIN)	15.75
shower head singer cold water 0.1Mpa(L/MIN)	6.1
shower head singer cold water 0.3Mpa(L/MIN)	11.58
shower head singer cold water 0.5Mpa(L/MIN)	15.37

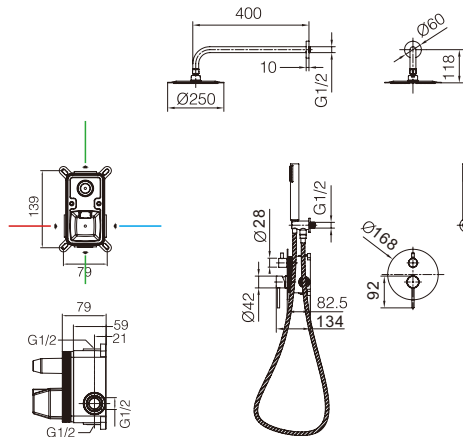
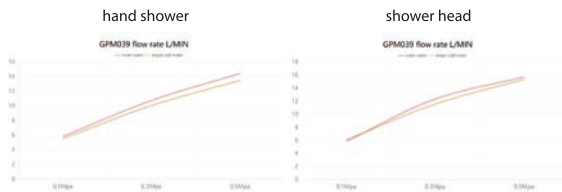

Product sizes (cm)	43*30*14
Weight (kg)	4.3
Guarantee	5 years
Max Preasure (bar)	5
Min Preasure (bar)	0.5
Optimum preasure (bar)	1-4 (Recommended 3)
Max. temperature	85°C
Min temperature	65°C

CERTIFIES

That all our products, provided that they are used in normal conditions or installed in accordance with current standards, are guaranteed against any manufacturing defect for a period of five years, except for products purchased before January 1, 2020, which will have the mandatory coverage of 2 years from the date of invoice.

Requirements and exclusions

Failure to comply with the instructions for assembly, use and maintenance of our products on the packaging and in our catalogue and published on our website: www.imexproducts.es, releases IMEX PRODUCTS, S.L. from any liability.

In any case, the acceptance of the defect by our technical department is necessary. In addition, transport costs will be charged only in the event that on IMEX PRODUCTS, S.L. technician determines the proper functioning of our products.

IMEX PRODUCTS, S.L. will decide to repair the product or replace it. It will be necessary to present the purchase invoice.

Assembly, maintenance or repairs carried out by non-specoalists re excluded from the warranty.

Wearing parts such as hoses, handles, seals, filters, aerators, etc. are not covered by the warranty.



**PRODUCT
INFORMATION
SUMMARY**

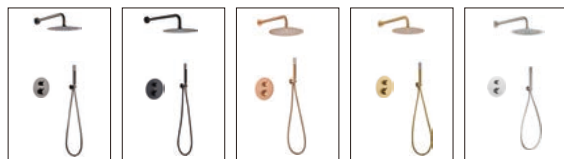

Ref.	EAN	Finish
GTM039	8435668030205	Chrome
GTM039-BGM	8435668030212	Black gun metal
GTM039-NG	8435668030229	Matte black
GTM039-ORC	8435668030243	Brushed rose gold
GTM039-OC	8435668030236	Brushed gold
GTM039-NQ	8435668056656	Brushed nickel

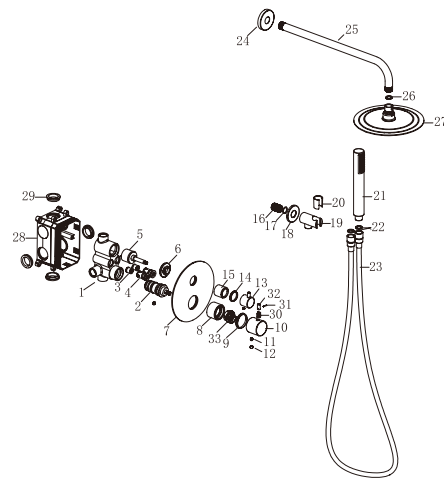

CODE	NAME	MATERIAL	REF	CODE	NAME	MATERIAL	REF
1	Body	Brass		20	Plastic washer	Plastic	
2	Cartridge	32mm	CRT012*	21	Shower	Plastic	MDR015*
3	Check valve	ASSY		22	Rubber ring	NBR	
4	Control valve	ASSY		23	Hose	PVC	FLX002*
5	cartridge	33mm up	???	24	Caver	SUS 304	
6	Nut	Brass		25	Hose	SUS 304	BPR001*
7	Decorative plate	SUS 304		26	Rubber ring	NBR	
8	Cartridge cover	Brass		27	Shower head	SUS 304	RDN002*
9	Plastic washer	Plastic		28	BOX	ABS	
10	Handle	Zinc		29	Rubber ring	NBR	
11	Screw	SUS 304		30	Spring	SUS 304	
12	Button	ABS		31	Pin	SUS 304	
13	Handle	Zinc		32	Handle lever	Brass	
14	Plastic washer	Plastic		33	Washer	POM	
15	Cover	Brass					
16	Connect	Brass					
17	Oring	NBR					
18	Cover	Brass					
19	Body	Brass					

* CONSULTAR PARA ACABADOS DE COLOR

Installing instruction

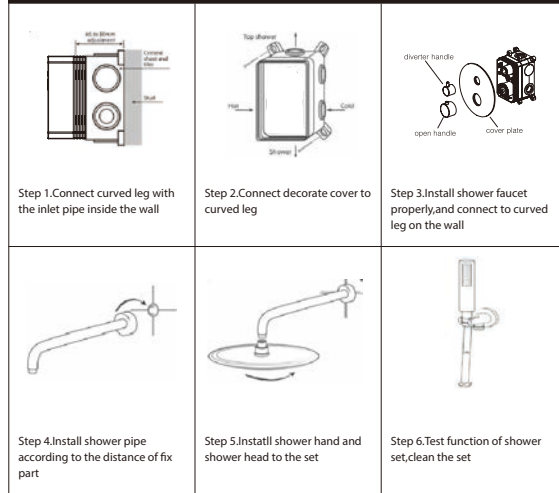

Usage function instruction

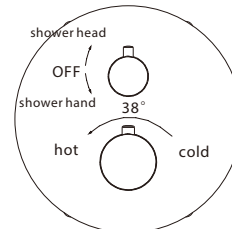

FLOW RATE

Detalles	
FLOW RATE REF	GTM039
hand shower mixer water 0.1Mpa(L/MIN)	5.27
hand shower mixer water 0.3Mpa(L/MIN)	9.62
hand shower mixer water 0.5Mpa(L/MIN)	12.84
hand shower singer cold water 0.1Mpa(L/MIN)	4.95
hand shower singer cold water 0.3Mpa(L/MIN)	9.02
hand shower singer cold water 0.5Mpa(L/MIN)	11.95
shower head mixer water 0.1Mpa(L/MIN)	6.1
shower head mixer water 0.3Mpa(L/MIN)	11.16
shower head mixer water 0.5Mpa(L/MIN)	14.76
shower head singer cold water 0.1Mpa(L/MIN)	5.63
shower head singer cold water 0.3Mpa(L/MIN)	10.28
shower head singer cold water 0.5Mpa(L/MIN)	13.6

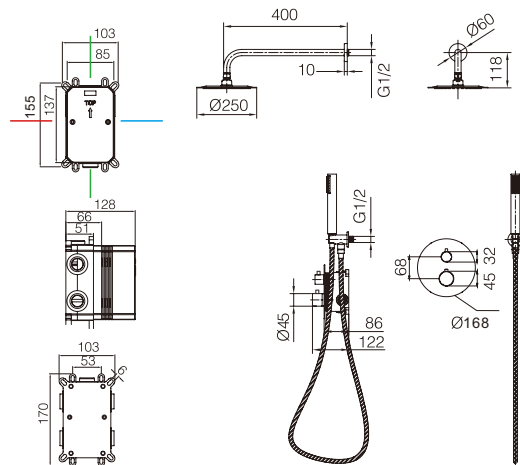

Product sizes (cm)	43*30*14
Weight (kg)	4.8
Guarantee	5 years
Max Preasure (bar)	5
Min Preasure (bar)	0.5
Optimum preasure (bar)	1-4 (Recommended 3)
Max. temperature	85°C
Min temperature	65°C

hand shower

shower head

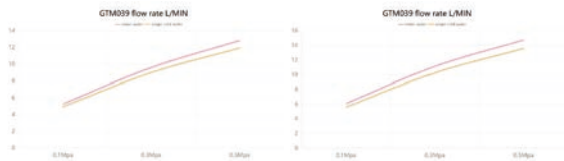

CERTIFIES

That all our products, provided that they are used in normal conditions or installed in accordance with current standards, are guaranteed against any manufacturing defect for a period of five years, except for products purchased before January 1, 2020, which will have the mandatory coverage of 2 years from the date of invoice.

Requirements and exclusions

Failure to comply with the instructions for assembly, use and maintenance of our products on the packaging and in our catalogue and published on our website: www.imexproducts.es, releases IMEX PRODUCTS, S.L. from any liability.

In any case, the acceptance of the defect by our technical department is necessary. In addition, transport costs will be charged only in the event that on IMEX PRODUCTS, S.L. technician determines the proper functioning of our products.

IMEX PRODUCTS, S.L. will decide to repair the product or replace it. It will be necessary to present the purchase invoice.

Assembly, maintenance or repairs carried out by non-specialists are excluded from the warranty.

Wearing parts such as hoses, handles, seals, filters, aerators, etc. are not covered by the warranty.



**PRODUCT
INFORMATION
SUMMARY**

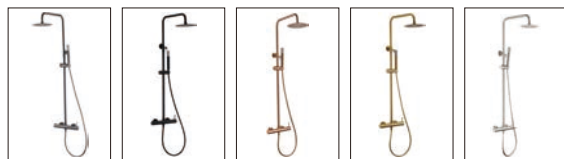

Ref.	EAN	Finish
BDM039	8435668030151	Chrome
BDM039-BGM	8435668030168	Black gun metal
BDM039-NG	8435668030175	Matte black
BDM039-ORC	8435668030199	Brushed rose gold
BDM039-OC	8435668030182	Brushed gold
BDM039-NQ	8435668056700	Brushed nickel

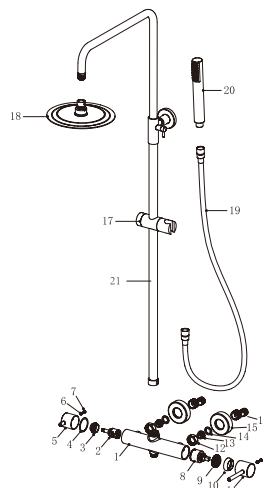

CODE	NAME	MATERIAL	REF	CODE	NAME	MATERIAL	REF
1	Body	Brass		16	Cabrio leg	SUS 304	
2	Cartridge	25mm up	CRT068*	17	Slider	SUS 304	AR00014*
3	Nut	Brass		18	Shower head	SUS 304	RDN0001*
4	Washer	POM		19	Hose	SUS 304 / PVC	FLX0001*
5	Handle	Zinc		20	Shower hand	ABS	MDR015*
6	Screw	SUS 304		21	Pipe	SUS 304	
7	Cover	ABS					
8	Cartridge	35mm	CRT006*				
9	Nut	Brass					
10	Cover	ABS					
11	Handle	Zinc					
12	Nut	Brass					
13	Valve	SUS 304					
14	Rubber ring	NBR					
15	Cover	SUS 304					

* CONSULTAR PARA ACABADOS DE COLOR

Installing instruction

Step 1. Connect curved leg with the inlet pipe inside the wall

Step 2. Connect decorate cover to curved leg

Step 3. Install shower faucet properly and connect to curved leg on the wall

Step 4. Install shower pipe according to the distance of fix part

Step 5. Install shower hand and shower head to the set

Step 6. Test function of shower set, clean the set

Usage function instruction

90° Cold Hot

close open

SHOWER HEAD SHOWER HAND

MONZA

Series

IMEX
BATH EQUIPMENTS

MONZA

Series

IMEX
BATH EQUIPMENTS

MONZA

Series

IMEX
BATH EQUIPMENTS

FLOW RATE

Detalles	
FLOW RATE REF	BDM039
hand shower mixer water 0.1Mpa(L/MIN)	6.03
hand shower mixer water 0.3Mpa(L/MIN)	10.95
hand shower mixer water 0.5Mpa(L/MIN)	14.84
hand shower singer cold water 0.1Mpa(L/MIN)	5.98
hand shower singer cold water 0.3Mpa(L/MIN)	10.86
hand shower singer cold water 0.5Mpa(L/MIN)	14.61
shower head mixer water 0.1Mpa(L/MIN)	8.92
shower head mixer water 0.3Mpa(L/MIN)	15.58
shower head mixer water 0.5Mpa(L/MIN)	20.27
shower head singer cold water 0.1Mpa(L/MIN)	8.76
shower head singer cold water 0.3Mpa(L/MIN)	15.24
shower head singer cold water 0.5Mpa(L/MIN)	19.75

hand shower

shower head

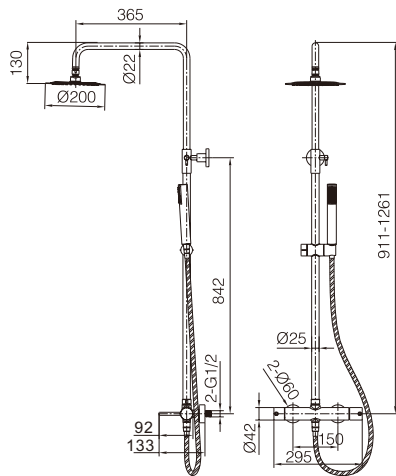
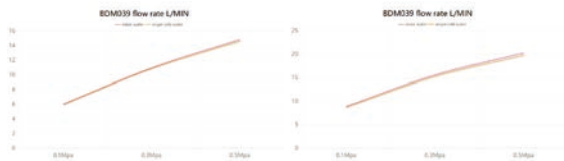

Product sizes (cm)	42.5*13.3*90
Weight (kg)	5.6
Guarantee	5 years
Max Preassure (bar)	5
Min Preassure (bar)	0.5
Optimum preassure (bar)	1-4 (Recommended 3)
Max. temperature	85°C
Min temperature	65°C

CERTIFIES

That all our products, provided that they are used in normal conditions or installed in accordance with current standards, are guaranteed against any manufacturing defect for a period of five years, except for products purchased before January 1, 2020, which will have the mandatory coverage of 2 years from the date of invoice.

Requirements and exclusions

Failure to comply with the instructions for assembly, use and maintenance of our products on the packaging and in our catalogue and published on our website: www.imexproducts.es, releases IMEX PRODUCTS, S.L. from any liability.

In any case, the acceptance of the defect by our technical department is necessary. In addition, transport costs will be charged only in the event that on IMEX PRODUCTS, S.L. technician determines the proper functioning of our products.

IMEX PRODUCTS, S.L. will decide to repair the product or replace it. It will be necessary to present the purchase invoice.

Assembly, maintenance or repairs carried out by non-specialists are excluded from the warranty.

Wearing parts such as hoses, handles, seals, filters, aerators, etc. are not covered by the warranty.



**PRODUCT
INFORMATION
SUMMARY**

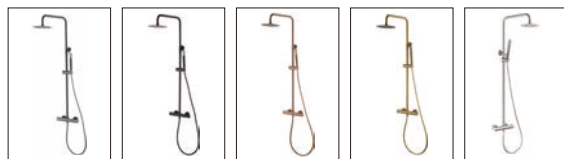

Ref.	EAN	Finish
BTM039	8435668030250	Chrome
BTM039-BGM	8435668030267	Black gun metal
BTM039-NG	8435668030274	Matte black
BTM039-ORC	8435668030298	Brushed rose gold
BTM039-OC	8435668030281	Brushed gold
BTM039-NQ	8435668056724	Brushed nickel

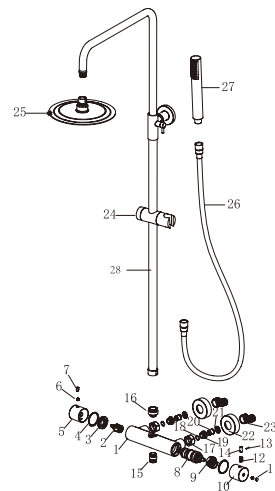

CODE	NAME	MATERIAL	REF	CODE	NAME	MATERIAL	REF
1	Body	Brass	16	Connect	Brass		
2	Cartridge	25mm up	???	17	Nut	Brass	
3	Nut	Brass	18	O-ring	NBR		
4	Washer	POM	19	Screw	SUS 304		
5	Handle	Zinc	20	Valve	ABS		
6	Screw	SUS 304	21	Rubber washer	NBR		
7	Handle lever	Brass	22	Cover	SUS 304		
8	Cartridge	32mm	CRT012*	23	Cabrio leg	SUS 304	
9	Washer	POM	24	Slider	SUS 304	RR0014*	
10	Handle	Zinc	25	Shower head	SUS 304	RDN001*	
11	Cover	ABS	26	Hose	SUS 304 / PVC	FLX001*	
12	Spring	SUS 304	27	Shower hand	ABS	MDR015*	
13	Pin	SUS 304	28	Pipe	SUS 304		
14	Handle lever	Brass					
15	Connect	Brass					

* CONSULTAR PARA ACABADOS DE COLOR

Installing instruction

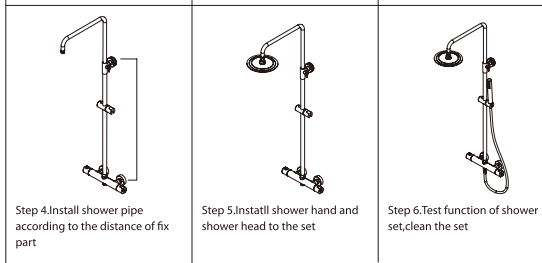
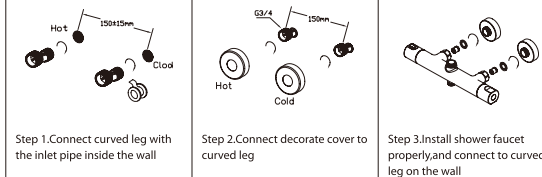

Usage function instruction

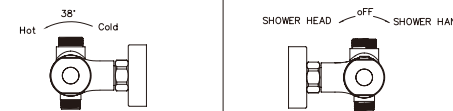

FLOW RATE

Detalles	
FLOW RATE REF	BTM039
hand shower mixer water 0.1Mpa(L/MIN)	5.77
hand shower mixer water 0.3Mpa(L/MIN)	10.57
hand shower mixer water 0.5Mpa(L/MIN)	14.24
hand shower singer cold water 0.1Mpa(L/MIN)	5.58
hand shower singer cold water 0.3Mpa(L/MIN)	10.12
hand shower singer cold water 0.5Mpa(L/MIN)	13.57
shower head mixer water 0.1Mpa(L/MIN)	8.43
shower head mixer water 0.3Mpa(L/MIN)	14.97
shower head mixer water 0.5Mpa(L/MIN)	19.57
shower head singer cold water 0.1Mpa(L/MIN)	7.77
shower head singer cold water 0.3Mpa(L/MIN)	13.7
shower head singer cold water 0.5Mpa(L/MIN)	17.8

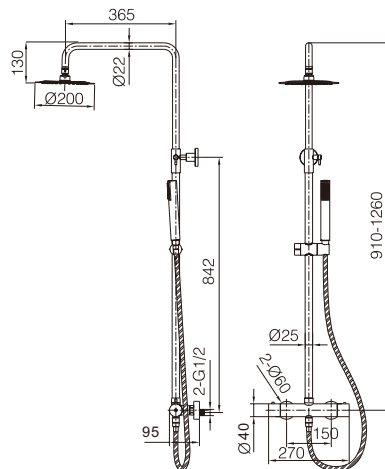
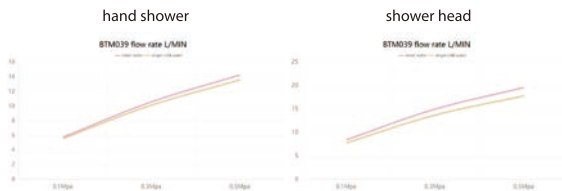

Product sizes (cm)	42.5*13.3*90
Weight (kg)	5.5
Guarantee	5 years
Max Preassure (bar)	5
Min Preassure (bar)	0.5
Optimum preassure (bar)	1-4 (Recommended 3)
Max. temperature	85°C
Min temperature	65°C

CERTIFIES

That all our products, provided that they are used in normal conditions or installed in accordance with current standards, are guaranteed against any manufacturing defect for a period of five years, except for products purchased before January 1, 2020, which will have the mandatory coverage of 2 years from the date of invoice.

Requirements and exclusions

Failure to comply with the instructions for assembly, use and maintenance of our products on the packaging and in our catalogue and published on our website: www.imexproducts.es, releases IMEX PRODUCTS, S.L. from any liability.

In any case, the acceptance of the defect by our technical department is necessary. In addition, transport costs will be charged only in the event that on IMEX PRODUCTS, S.L. technician determines the proper functioning of our products.

IMEX PRODUCTS, S.L. will decide to repair the product or replace it. It will be necessary to present the purchase invoice.

Assembly, maintenance or repairs carried out by non-specialists are excluded from the warranty.

Wearing parts such as hoses, handles, seals, filters, aerators, etc. are not covered by the warranty.



**PRODUCT
INFORMATION
SUMMARY**



Ref.	EAN	Finish
GLM039	8435668030663	Chrome
GLM039-BGM	8435668030670	Black gun metal
GLM039-NG	8435668030687	Matte black
GLM039-ORC	8435668030700	Brushed rose gold
GLM039-OC	8435668030694	Brushed gold
GLM039-NQ	8435668056618	Brushed nickel

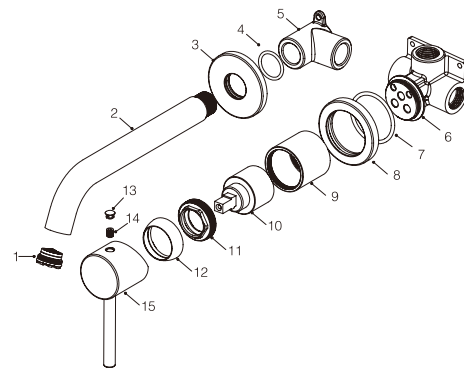

CODE	NAME	MATERIAL	REF
1	Aerator	16.5x1mm	SAT-AIR060*
2	Outlet pipe	Brass	
3	Cover	Brass	
4	O-ring	NBR	
5	Connector	Brass	
6	Body	Brass	
7	O-ring	NBR	
8	Cover	Brass	
9	Cartridge cover	Brass	
10	Cartridge	35mm	CRT006*
11	Nut	Brass	
12	Cover	ABS	
13	Screw	SUS 304	
14	Cover	ABS	
15	Handle	Zinc	

* CONSULTAR PARA ACABADOS DE COLOR

Installing instruction

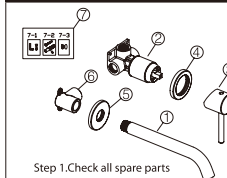

- Step 1. Check all spare parts
 1-pipe
 2-body to handle
 3-handle
 4-cover plate of handle
 5-cover plate of pipe
 6-body to pipe
 7-spare part bag

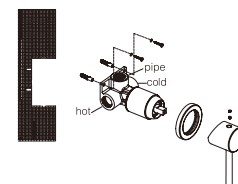

- Step 2. Dig hole for body to handle
 2.1-Hole size 50*50mm, depth from 45 to 75mm
 2.2-Dig two 6mm holes with 54mm distance
 2.3- Assemble spare parts as picture shows

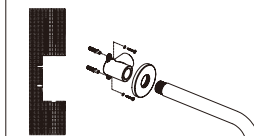

- Step 3. Dig hole for body to pipe
 3.1-Hole size 45*45mm, depth 40mm
 3.2-Dig two 6mm holes with 35mm distance
 3.3- Assemble spare parts as picture shows

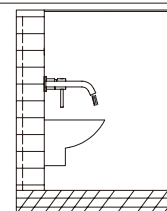

- Step 4. Connect inside pipe and test for leak checking

Usage function instruction

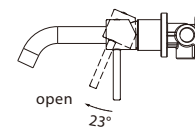
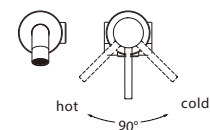

FLOW RATE

Detalles	
FLOW RATE REF	GLM039
mixer water 0.1Mpa(L/MIN)	5.46
mixer water 0.3Mpa(L/MIN)	9.49
mixer water 0.5Mpa(L/MIN)	12.31
singer cold water 0.1Mpa(L/MIN)	5.3
singer cold water 0.3Mpa(L/MIN)	9.08
singer cold water 0.5Mpa(L/MIN)	11.77

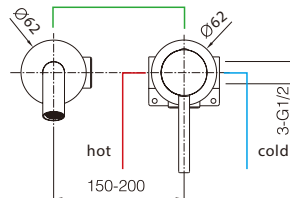
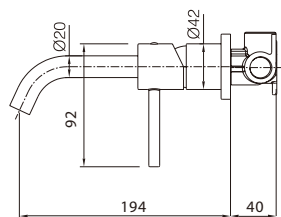
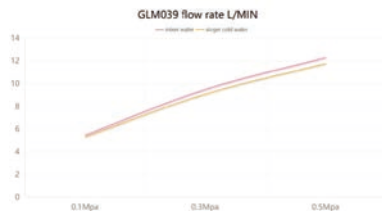

Product sizes (cm)	29*17.5*6.7
Weight (kg)	1.1
Guarantee	5 years
Max Preasure (bar)	5
Min Preasure (bar)	0.5
Optimum preasure (bar)	1-4 (Recommended 3)
Max. temperature	85°C
Min temperature	65°C

CERTIFIES

That all our products, provided that they are used in normal conditions or installed in accordance with current standards, are guaranteed against any manufacturing defect for a period of five years, except for products purchased before January 1, 2020, which will have the mandatory coverage of 2 years from the date of invoice.

Requirements and exclusions

Failure to comply with the instructions for assembly, use and maintenance of our products on the packaging and in our catalogue and published on our website: www.imexproducts.es, releases IMEX PRODUCTS, S.L. from any liability.

In any case, the acceptance of the defect by our technical department is necessary. In addition, transport costs will be charged only in the event that on IMEX PRODUCTS, S.L. technician determines the proper functioning of our products.

IMEX PRODUCTS, S.L. will decide to repair the product or replace it. It will be necessary to present the purchase invoice.

Assembly, maintenance or repairs carried out by non-specialists are excluded from the warranty.

Wearing parts such as hoses, handles, seals, filters, aerators, etc. are not covered by the warranty.

