

PRODUCT INFORMATION SUMMARY

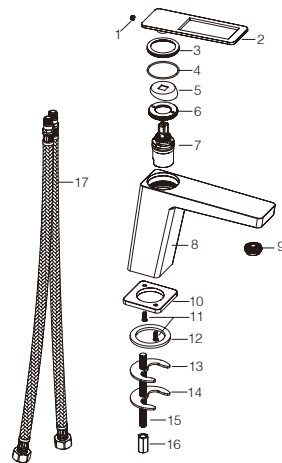

Ref.	EAN	Finish
BDC032-1	8435668002714	Chrome
BDC032-1NG	8435668002721	Negro mate
BDC032-1NGOLD	8435668002738	Negro oro
BDC032-1NOR	8435668002745	Negro oro rosa



CODE	NAME	MATERIAL	REF
1	Screw	SUS 304	
2	Handle	SUS 304	
3	Decorative ring	Brass	
4	O-ring	NBR	
5	Decorative cup	ABS	
6	Nut	Brass	
7	Cartridge	26mm up	CRT007*
8	Body	Brass	
9	Aerator	M24x1mm	SAT-AIR019*
10	Base	Brass	
11	Screw	SUS 304	
12	Rubber ring	NBR	
13	Rubber washer	NBR	
14	Metal washer	SUS 304	
15	M8-screw	SUS 304	
16	M8-nut	Brass	
17	Connecting Pipe	TAQ-PEX-DN6-ACB H3/8-M10X1 L12-500-R8B	SAT-HOSES7*

* CONSULTAR PARA ACABADOS DE COLOR

Installing instruction

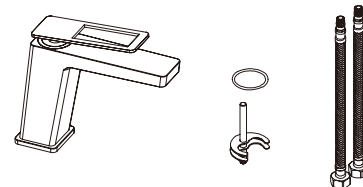

Step 1. Check all spare parts ready

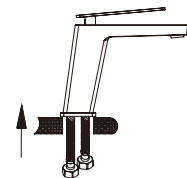

Step 2. Install inlet pipe to faucet body

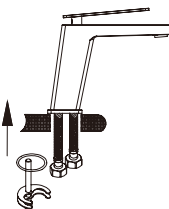

Step 3. Install screw stick to faucet body

FLOW RATE

Detalles	
FLOW RATE REF	BDC032-1
mixer water 0.1Mpa(L/MIN)	4.67
mixer water 0.3Mpa(L/MIN)	7.83
mixer water 0.5Mpa(L/MIN)	9.71
singer cold water 0.1Mpa(L/MIN)	4.43
singer cold water 0.3Mpa(L/MIN)	7.57
singer cold water 0.5Mpa(L/MIN)	9.42

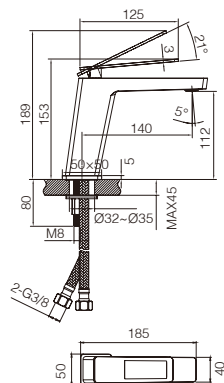
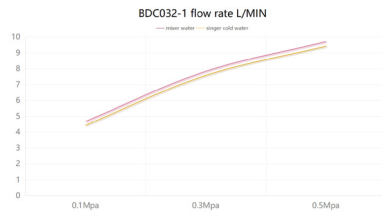

Product sizes (cm)	30*21*5.9
Weight (kg)	1.42
Guarantee	5 years
Max Preassure (bar)	5
Min Preassure (bar)	0.5
Optimum preassure (bar)	1-4 (Recommended 3)
Max. temperature	85°C
Min temperature	65°C

CERTIFIES

That all our products, provided that they are used in normal conditions or installed in accordance with current standards, are guaranteed against any manufacturing defect for a period of five years, except for products purchased before January 1, 2020, which will have the mand atory coverage of 2 years from the date of invoice.

Requirements and exclusions

Failure to comply with the instructions for assembly, use and maintenance of our products on the packaging and in our catalogue and published on our website: www.imexproducts.es, releases IMEX PRODUCTS, S.L. from any liability.

In any case, the acceptance of the defect by our technical department is necessary. In addition, transport costs will be charged only in the event that on IMEX PRODUCTS, S.L. technician determines the proper functioning of our products.

IMEX PRODUCTS, S.L. will decide to repair the product or replace it. It will be necessary to present the purchase invoice.

Assembly, maintenance or repairs carried out by non-specoalists re excluded from the warranty.

Wearing parts such as hoses, handles, seals, filters, aerators, etc. are not covered by the warranty.



**PRODUCT
INFORMATION
SUMMARY**



Ref.	EAN	Finish
BDC032-2	8435668048279	Chrome
BDC032-2NG	8435668002769	Negro mate
BDC032-2NGOLD	8435668002776	Negro oro
BDC032-2NOR	8435668002783	Negro oro rosa

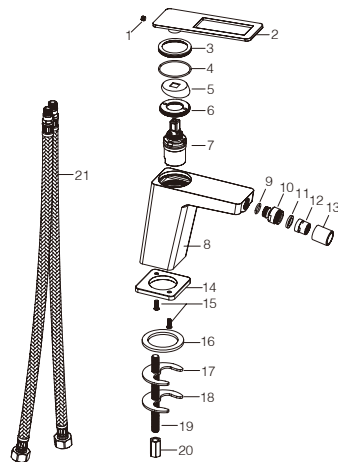

CODE	NAME	MATERIAL	REF	CODE	NAME	MATERIAL	REF
1	Screw	SUS 304		20	M8-nut	Brass	
2	Handle	SUS 304		21	Connecting Pipe	TAQ-PEX-DN6-ACB H3/8-M10X1 L12-500-R&B	SAT-HOSES7*
3	Decorative ring	Brass					
4	O-ring	NBR					
5	Decorative cup	ABS					
6	Nut	Brass					
7	Cartridge	26mm up	CRT007*				
8	Body	Brass					
9	O-ring	NBR					
10	Connector	Brass					
11	Rubber ring	NBR					
12	Aerator	22mm					
13	Aerator cover	Brass	SAT-AIR013*				
14	Base	Brass					
15	Screw	SUS 304					
16	Rubber ring	NBR					
17	Rubber washer	NBR					
18	Metal washer	SUS 304					
19	M8-screw	SUS 304					

* CONSULTAR PARA ACABADOS DE COLOR

Installing instruction

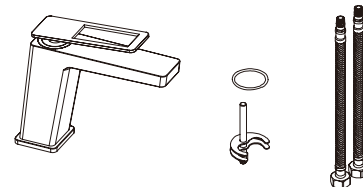

Step 1. Check all spare parts ready

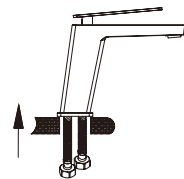

Step 2. Install inlet pipe to faucet body

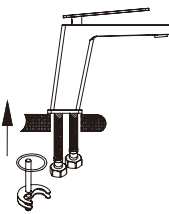

Step 3. Install screw stick to faucet body

FLOW RATE

Detalles	
FLOW RATE REF	BDC032-2
mixer water 0.1Mpa(L/MIN)	6.96
mixer water 0.3Mpa(L/MIN)	11.89
mixer water 0.5Mpa(L/MIN)	15.28
singer cold water 0.1Mpa(L/MIN)	4.83
singer cold water 0.3Mpa(L/MIN)	8.21
singer cold water 0.5Mpa(L/MIN)	10.26

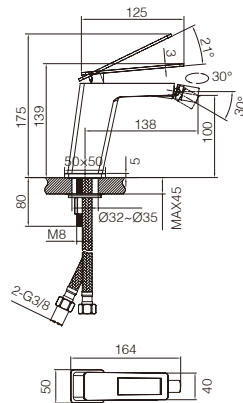
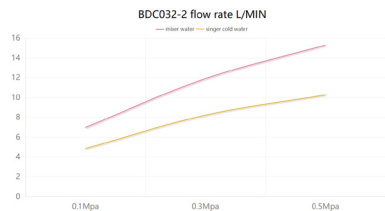

Product sizes (cm)	26.7*18.1*5.9
Weight (kg)	1.26
Guarantee	5 years
Max Preassure (bar)	5
Min Preassure (bar)	0.5
Optimum preassure (bar)	1-4 (Recommended 3)
Max. temperature	85°C
Min temperature	65°C

CERTIFIES

That all our products, provided that they are used in normal conditions or installed in accordance with current standards, are guaranteed against any manufacturing defect for a period of five years, except for products purchased before January 1, 2020, which will have the mand atory coverage of 2 years from the date of invoice.

Requirements and exclusions

Failure to comply with the instructions for assembly, use and maintenance of our products on the packaging and in our catalogue and published on our website: www.imexproducts.es, releases IMEX PRODUCTS, S.L. from any liability.

In any case, the acceptance of the defect by our technical department is necessary. In addition, transport costs will be charged only in the event that on IMEX PRODUCTS, S.L. technician determines the proper functioning of our products.

IMEX PRODUCTS, S.L. will decide to repair the product or replace it. It will be necessary to present the purchase invoice.

Assembly, maintenance or repairs carried out by non-specoalists re excluded from the warranty.

Wearing parts such as hoses, handles, seals, filters, aerators, etc. are not covered by the warranty.



**PRODUCT
INFORMATION
SUMMARY**



Ref.	EAN	Finish
BDC032-3	8435668002790	Chrome
BDC032-3NG	8435668002806	Negro mate
BDC032-3NGOLD	8435668002813	Negro oro
BDC032-3NOR	8435668002820	Negro oro rosa

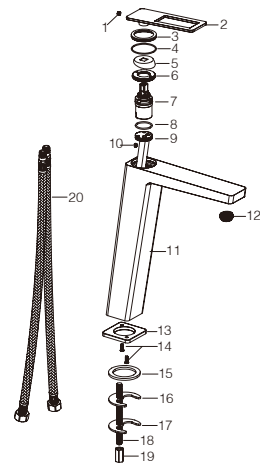

CODE	NAME	MATERIAL	REF	CODE	NAME	MATERIAL	REF
1	Screw	SUS 304					
2	Handle	SUS 304		20	Connecting Pipe	TAQ-PEX-DN6-ACB H3/8-M10X1 L132-500-R&B	SAT-HOSES7*
3	Decorative ring	Brass					
4	O-ring	NBR					
5	Decorative cup	ABS					
6	Nut	Brass					
7	Cartridge	26mm up	CRT007*				
8	O-ring	NBR					
9	Cartridge base	Brass					
10	Screw	SUS 304					
11	Body	Brass					
12	Aerator	M24x1mm	SAT-AIR019*				
13	Base	Brass					
14	Screw	SUS 304					
15	Rubber ring	NBR					
16	Rubber washer	NBR					
17	Metal washer	SUS 304					
18	M8-screw	SUS 304					
19	M8-nut	Brass					

* CONSULTAR PARA ACABADOS DE COLOR

Installing instruction

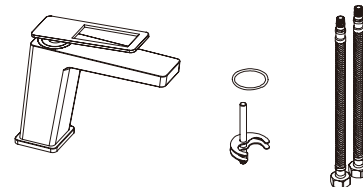

Step 1. Check all spare parts ready

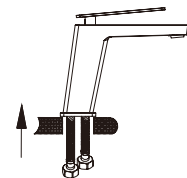

Step 2. Install inlet pipe to faucet body

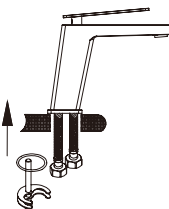

Step 3. Install screw stick to faucet body

FLOW RATE

Detalles	
FLOW RATE REF	BDC032-3
mixer water 0.1Mpa(L/MIN)	4.8
mixer water 0.3Mpa(L/MIN)	8.21
mixer water 0.5Mpa(L/MIN)	10.02
singer cold water 0.1Mpa(L/MIN)	4.51
singer cold water 0.3Mpa(L/MIN)	7.77
singer cold water 0.5Mpa(L/MIN)	9.62

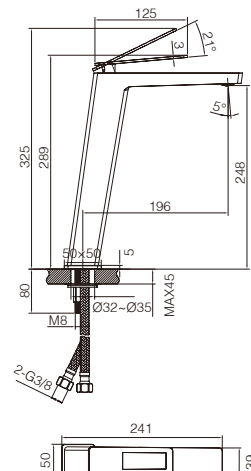
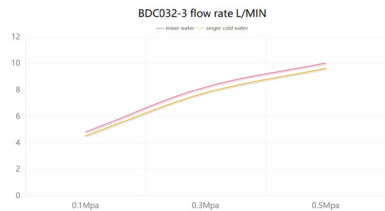

Product sizes (cm)	39*21*5.9
Weight (kg)	1.87
Guarantee	5 years
Max Preassure (bar)	5
Min Preassure (bar)	0.5
Optimum preassure (bar)	1-4 (Recommended 3)
Max. temperature	85°C
Min temperature	65°C

CERTIFIES

That all our products, provided that they are used in normal conditions or installed in accordance with current standards, are guaranteed against any manufacturing defect for a period of five years, except for products purchased before January 1, 2020, which will have the mand atory coverage of 2 years from the date of invoice.

Requirements and exclusions

Failure to comply with the instructions for assembly, use and maintenance of our products on the packaging and in our catalogue and published on our website: www.imexproducts.es, releases IMEX PRODUCTS, S.L. from any liability.

In any case, the acceptance of the defect by our technical department is necessary. In addition, transport costs will be charged only in the event that on IMEX PRODUCTS, S.L. technician determines the proper functioning of our products.

IMEX PRODUCTS, S.L. will decide to repair the product or replace it. It will be necessary to present the purchase invoice.

Assembly, maintenance or repairs carried out by non-specoalists re excluded from the warranty.

Wearing parts such as hoses, handles, seals, filters, aerators, etc. are not covered by the warranty.



PRODUCT INFORMATION SUMMARY

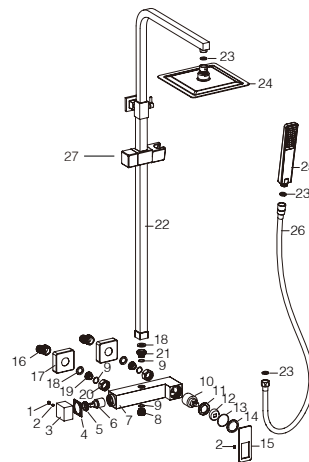

Ref.	EAN	Finish
BDC032	8435668002950	Chrome
BDC032/NG	8435668002967	Negro mate
BDC032/NGOLD	8435668002974	Negro oro
BDC032/NOR	8435668002981	Negro oro rosa

CODE	NAME	MATERIAL	REF	CODE	NAME	MATERIAL	REF
1	Button	ABS		16	Cabrio leg	SUS 304	
2	Screw	SUS 304		17	Cover	SUS 304	
3	Handle	Zinc		18	Rubber ring	NBR	
4	Plastic washer	Plastic		19	Screw	SUS 304	
5	Nut	Brass		20	Nut	Brass	
6	Cartridge	25mm up		21	Connect	Brass	
7	Body	Brass		22	Pipe	SUS 304	RR0013*
8	Connect	Brass		23	Rubber ring	NBR	
9	O-ring	NBR		24	Shower head	SUS 304	RDC001*
10	Cartridge	35mm	CRT006*	25	Shower hand	ABS	MDM013*
11	Nut	Brass		26	Hose	SUS 304 / PVC	FLX001*
12	Decorative cup	Brass		27	Shower seat	Plastic	RR0016*
13	O-ring	NBR					
14	Decorative ring	Brass					
15	Handle	SUS 304					

* CONSULTAR PARA ACABADOS DE COLOR

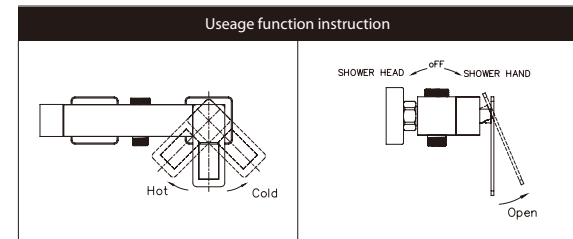
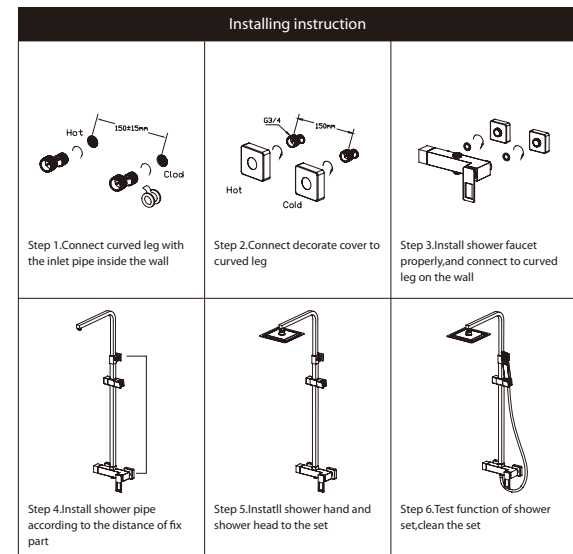

FLOW RATE

Detalles	
FLOW RATE REF	BDC032
hand shower mixer water 0.1Mpa(L/MIN)	5.43
hand shower mixer water 0.3Mpa(L/MIN)	10.02
hand shower mixer water 0.5Mpa(L/MIN)	13.65
hand shower singer cold water 0.1Mpa(L/MIN)	5.37
hand shower singer cold water 0.3Mpa(L/MIN)	9.79
hand shower singer cold water 0.5Mpa(L/MIN)	13.2
shower head mixer water 0.1Mpa(L/MIN)	6.99
shower head mixer water 0.3Mpa(L/MIN)	12.54
shower head mixer water 0.5Mpa(L/MIN)	16.74
shower head singer cold water 0.1Mpa(L/MIN)	6.75
shower head singer cold water 0.3Mpa(L/MIN)	12.1
shower head singer cold water 0.5Mpa(L/MIN)	16.09

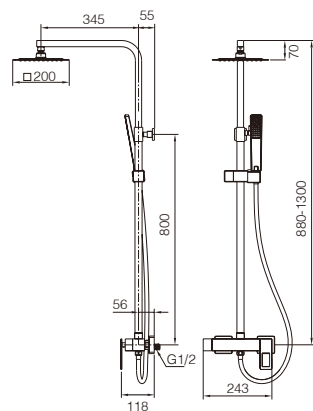
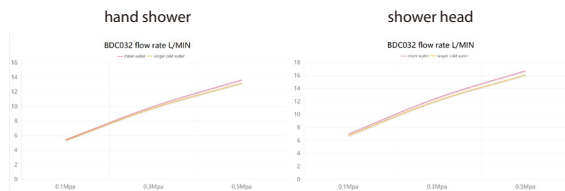

Product sizes (cm)	42.5*13.3*90
Weight (kg)	5.9
Guarantee	5 years
Max Preassure (bar)	5
Min Preassure (bar)	0.5
Optimum preassure (bar)	1-4 (Recommended 3)
Max. temperature	85°C
Min temperature	65°C

CERTIFIES

That all our products, provided that they are used in normal conditions or installed in accordance with current standards, are guaranteed against any manufacturing defect for a period of five years, except for products purchased before January 1, 2020, which will have the mand atory coverage of 2 years from the date of invoice.

Requirements and exclusions

Failure to comply with the instructions for assembly, use and maintenance of our products on the packaging and in our catalogue and published on our website: www.imexproducts.es, releases IMEX PRODUCTS, S.L. from any liability.

In any case, the acceptance of the defect by our technical department is necessary. In addition, transport costs will be charged only in the event that on IMEX PRODUCTS, S.L. technician determines the proper functioning of our products.

IMEX PRODUCTS, S.L. will decide to repair the product or replace it. It will be necessary to present the purchase invoice.

Assembly, maintenance or repairs carried out by non-specoalists re excluded from the warranty.

Wearing parts such as hoses, handles, seals, filters, aerators, etc. are not covered by the warranty.



**PRODUCT
INFORMATION
SUMMARY**

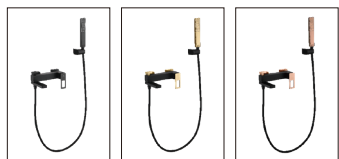

Ref.	EAN	Finish
BDC032-7	8435668012447	Chrome
BDC032-7NG	8435668012591	Negro mate
BDC032-7NGOLD	8435668012614	Negro oro
BDC032-7NOR	8435668012775	Negro oro rosa

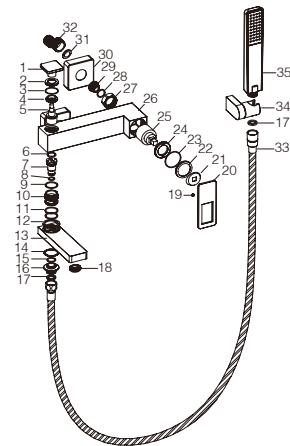

CODE	NAME	MATERIAL	REF	CODE	NAME	MATERIAL	REF
1	Handle	Brass		20	Handle	SUS 304	
2	Cover	Brass		21	Cover	Brass	
3	O-ring	NBR		22	Decorative ring	Brass	
4	Nut	Brass		23	O-ring	NBR	
5	Cartridge	22mm		24	Nut	Brass	
6	O-ring	NBR		25	Cartridge	35mm	CRT006*
7	Connect	Brass		26	Body	Brass	
8	O-ring	NBR		27	Nut	Brass	
9	O-ring	NBR		28	O-ring	NBR	
10	Connect	Brass		29	Screw	SUS 304	
11	O-ring	NBR		30	Cover	SUS 304	
12	Ring	Brass		31	Rubber	NBR	
13	Water outlet nozzle	Brass		32	Carioleg	SUS 304	
14	Ring	POM		33	Hose	SUS 304	FLX004*
15	O-ring	NBR		34	Shower seat	ABS	SMD007*
16	Connect	Brass		35	Shower hand	ABS	MDM013*
17	Ring	NBR					
18	Aerator	M24x1mm	SAT-AIR019*				
19	Screw	SUS 304					

* CONSULTAR PARA ACABADOS DE COLOR

Installing instruction

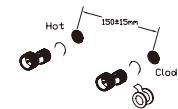

Step 1. Connect curved leg with the inlet pipe inside the wall

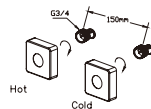

Step 2. Connect decorative cover to curved leg

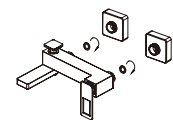

Step 3. Install shower faucet properly, and connect to curved leg on the wall

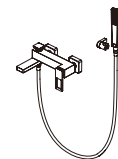

Step 4. Test function of shower set, clean the set

Usage function instruction

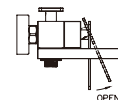
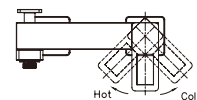

FLOW RATE

Detalles	
FLOW RATE REF	BDC032-7
hand shower mixer water 0.1Mpa(L/MIN)	6.1
hand shower mixer water 0.3Mpa(L/MIN)	11.7
hand shower mixer water 0.5Mpa(L/MIN)	14.98
hand shower singer cold water 0.1Mpa(L/MIN)	6.03
hand shower singer cold water 0.3Mpa(L/MIN)	10.96
hand shower singer cold water 0.5Mpa(L/MIN)	14.9
water outlet mixer water 0.1Mpa(L/MIN)	4.62
water outlet mixer water 0.3Mpa(L/MIN)	7.64
water outlet mixer water 0.5Mpa(L/MIN)	9.29
water outlet singer cold water 0.1Mpa(L/MIN)	4.56
water outlet singer cold water 0.3Mpa(L/MIN)	7.49
water outlet singer cold water 0.5Mpa(L/MIN)	9.28

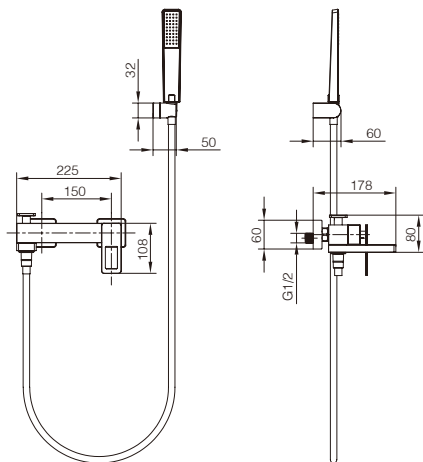

Product sizes (cm)	28*16*12.2
Weight (kg)	2.85
Guarantee	5 years
Max Preassure (bar)	5
Min Preassure (bar)	0.5
Optimum preassure (bar)	1-4 (Recommended 3)
Max. temperature	85°C
Min temperature	65°C

hand shower

water outlet

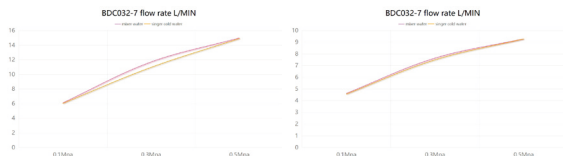

CERTIFIES

That all our products, provided that they are used in normal conditions or installed in accordance with current standards, are guaranteed against any manufacturing defect for a period of five years, except for products purchased before January 1, 2020, which will have the mand atory coverage of 2 years from the date of invoice.

Requirements and exclusions

Failure to comply with the instructions for assembly, use and maintenance of our products on the packaging and in our catalogue and published on our website: www.imexproducts.es, releases IMEX PRODUCTS, S.L. from any liability.

In any case, the acceptance of the defect by our technical department is necessary. In addition, transport costs will be charged only in the event that on IMEX PRODUCTS, S.L. technician determines the proper functioning of our products.

IMEX PRODUCTS, S.L. will decide to repair the product or replace it. It will be necessary to present the purchase invoice.

Assembly, maintenance or repairs carried out by non-specoalists re excluded from the warranty.

Wearing parts such as hoses, handles, seals, filters, aerators, etc. are not covered by the warranty.



PRODUCT INFORMATION SUMMARY



Ref.	EAN	Finish
BDC032-6	8435668002912	Chrome
BDC032-6NG	8435668002929	Negro mate
BDC032-6NGOLD	8435668002936	Negro oro
BDC032-6NOR	8435668002943	Negro oro rosa

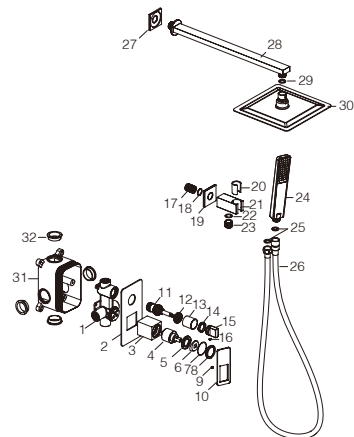

CODE	NAME	MATERIAL	REF	CODE	NAME	MATERIAL	REF
1	Body	Brass		20	ABS washer	ABS	
2	Decorative plate	SUS 304		21	Body	Brass	
3	Cartridge cover	Brass		22	O-ring	NBR	
4	Cartridge	35mm	CRT006*	23	Connect	Brass	
5	Nut	Brass		24	Shower hand	ABS	MDH013*
6	Decorative cup	ABS		25	Rubber ring	NBR	
7	O-ring	NBR		26	Hose	SUS 304	FLX001*
8	Decorative ring	Brass		27	Cover	Brass	
9	Screw	SUS 304		28	Hose	SUS 304	
10	Handle	SUS 304		29	Rubber ring	NBR	
11	Cartridge	Brass/27mm		30	Shower head	SUS 304	RDC002*
12	Nut	Brass		31	BOX	ABS	
13	Cover	Brass		32	Rubber ring	NBR	
14	ABS washer	ABS					
15	Handle	Zinc					
16	Screw	SUS 304					
17	Connect	Brass					
18	O-ring	NBR					
19	Cover	Brass					

* CONSULTAR PARA ACABADOS DE COLOR

Installing instruction

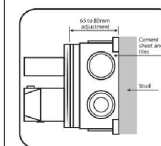

Step 1. Connect curved leg with the inlet pipe inside the wall

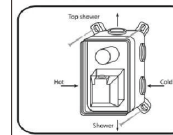

Step 2. Connect decorative cover to curved leg

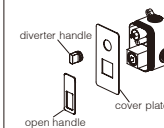

Step 3. Install shower faucet properly and connect to curved leg on the wall

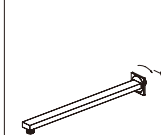

Step 4. Install shower pipe according to the distance of fix part

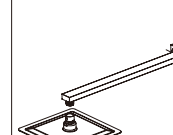

Step 5. Install shower hand and shower head to the set

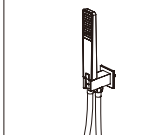

Step 6. Test function of shower set, clean the set

FLOW RATE

Detalles	
FLOW RATE REF	BDC032-6
hand shower mixer water 0.1Mpa(L/MIN)	5.95
hand shower mixer water 0.3Mpa(L/MIN)	10.85
hand shower mixer water 0.5Mpa(L/MIN)	14.5
hand shower singer cold water 0.1Mpa(L/MIN)	5.6
hand shower singer cold water 0.3Mpa(L/MIN)	10.1
hand shower singer cold water 0.5Mpa(L/MIN)	13.5
shower head mixer water 0.1Mpa(L/MIN)	6
shower head mixer water 0.3Mpa(L/MIN)	12.5
shower head mixer water 0.5Mpa(L/MIN)	15.9
shower head singer cold water 0.1Mpa(L/MIN)	6.2
shower head singer cold water 0.3Mpa(L/MIN)	11.7
shower head singer cold water 0.5Mpa(L/MIN)	15.5

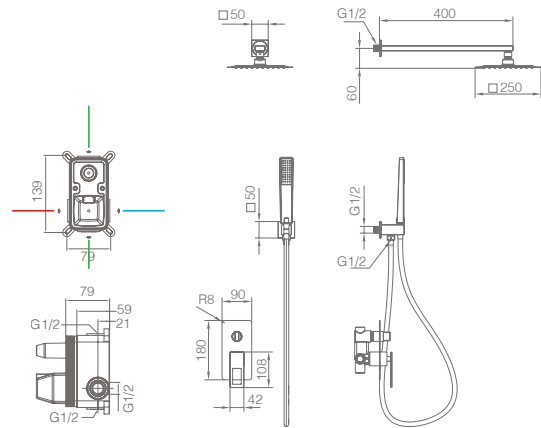
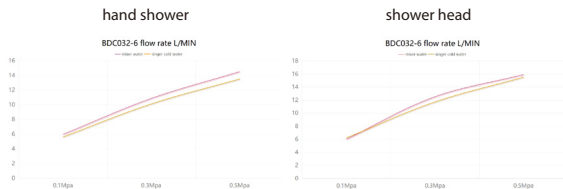

Product sizes (cm)	43*30*14
Weight (kg)	4.5
Guarantee	5 years
Max Preassure (bar)	5
Min Preassure (bar)	0.5
Optimum preassure (bar)	1-4 (Recommended 3)
Max. temperature	85°C
Min temperature	65°C

CERTIFIES

That all our products, provided that they are used in normal conditions or installed in accordance with current standards, are guaranteed against any manufacturing defect for a period of five years, except for products purchased before January 1, 2020, which will have the mand atory coverage of 2 years from the date of invoice.

Requirements and exclusions

Failure to comply with the instructions for assembly, use and maintenance of our products on the packaging and in our catalogue and published on our website: www.imexproducts.es, releases IMEX PRODUCTS, S.L. from any liability.

In any case, the acceptance of the defect by our technical department is necessary. In addition, transport costs will be charged only in the event that on IMEX PRODUCTS, S.L. technician determines the proper functioning of our products.

IMEX PRODUCTS, S.L. will decide to repair the product or replace it. It will be necessary to present the purchase invoice.

Assembly, maintenance or repairs carried out by non-specoalists re excluded from the warranty.

Wearing parts such as hoses, handles, seals, filters, aerators, etc. are not covered by the warranty.



PRODUCT INFORMATION SUMMARY



Ref.	EAN	Finish
BDC032-4	8435668002837	Chrome
BDC032-4NG	8435668002844	Negro mate
BDC032-4NGOLD	8435668002851	Negro oro
BDC032-4NOR	8435668002868	Negro oro rosa

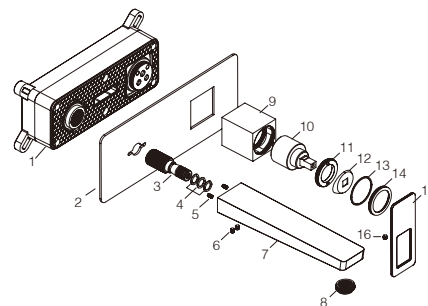

CODE	NAME	MATERIAL	REF
1	BOX	ASSY	
2	Decorative plate	SUS 304	
3	Connect	Brass	
4	O-ring	NBR	
5	Screw	SUS 304	
6	Screw	SUS 304	
7	Spout	Brass	
8	Aerator	M24x1mm	SAT-AIR019*
9	Cartridge cover	Brass	
10	Cartridge	35mm	CRT006*
11	Nut	Brass	
12	Decorative cup	ABS	
13	O-ring	NBR	
14	Decorative ring	Brass	
15	Handle	SUS 304	
16	Screw	SUS 304	

* CONSULTAR PARA ACABADOS DE COLOR

Installing instruction

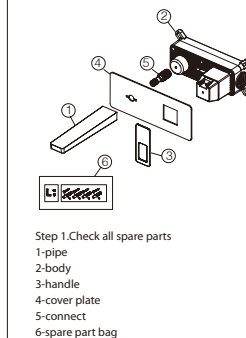

- Step 1. Check all spare parts
1-pipe
2-body
3-handle
4-cover plate
5-connect
6-spare part bag

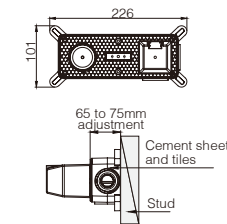

- Step 1. Connect curved leg with the inlet pipe inside the wall

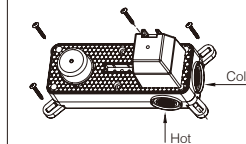

- Step 2. Connect decorate cover to curved leg

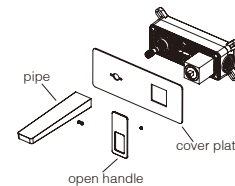

- Step 3. Install shower faucet properly, and connect to curved leg on the wall

FLOW RATE

Detalles	
FLOW RATE REF	BDC032-4
mixer water 0.1Mpa(L/MIN)	6.65
mixer water 0.3Mpa(L/MIN)	11.38
mixer water 0.5Mpa(L/MIN)	14.79
singer cold water 0.1Mpa(L/MIN)	6.23
singer cold water 0.3Mpa(L/MIN)	10.72
singer cold water 0.5Mpa(L/MIN)	13.98

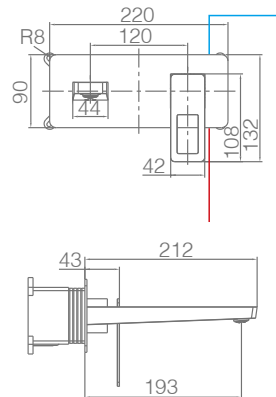
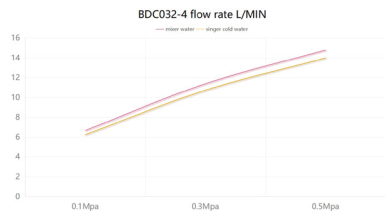

Product sizes (cm)	29*17.5*6.7
Weight (kg)	2.5
Guarantee	5 years
Max Preassure (bar)	5
Min Preassure (bar)	0.5
Optimum preassure (bar)	1-4 (Recommended 3)
Max. temperature	85°C
Min temperature	65°C

CERTIFIES

That all our products, provided that they are used in normal conditions or installed in accordance with current standards, are guaranteed against any manufacturing defect for a period of five years, except for products purchased before January 1, 2020, which will have the mand atory coverage of 2 years from the date of invoice.

Requirements and exclusions

Failure to comply with the instructions for assembly, use and maintenance of our products on the packaging and in our catalogue and published on our website: www.imexproducts.es, releases IMEX PRODUCTS, S.L. from any liability.

In any case, the acceptance of the defect by our technical department is necessary. In addition, transport costs will be charged only in the event that on IMEX PRODUCTS, S.L. technician determines the proper functioning of our products.

IMEX PRODUCTS, S.L. will decide to repair the product or replace it. It will be necessary to present the purchase invoice.

Assembly, maintenance or repairs carried out by non-specoalists re excluded from the warranty.

Wearing parts such as hoses, handles, seals, filters, aerators, etc. are not covered by the warranty.



PRODUCT INFORMATION SUMMARY

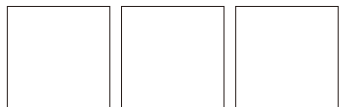

Ref.	EAN	Finish
BDC032-5	8435668048293	Chrome
BDC032-5NG	8435668002882	Negro mate
BDC032-5NGOLD	8435668002899	Negro oro
BDC032-5NOR	8435668002905	Negro oro rosa

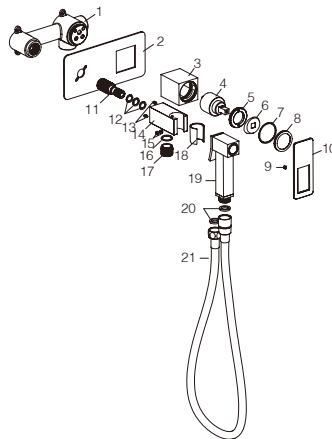

CODE	NAME	MATERIAL	REF	CODE	NAME	MATERIAL	REF
1	Body	Brass		20	Rubber ring	NBR	
2	Decorative plate	SUS 304		21	Hose	SUS 304/PVC	
3	Cartridge cover	Brass					
4	Cartridge	35mm					
5	Nut	Brass					
6	Decorative cup	ABS					
7	O-ring	NBR					
8	Decorative ring	Brass					
9	Screw	SUS 304					
10	Handle	SUS 304					
11	Connect	Brass					
12	O-ring	NBR					
13	Screw	SUS 304					
14	Body	Brass					
15	Screw	SUS 304					
16	O-ring	NBR					
17	Connect	Brass					
18	Plastic washer	Plastic					
19	Shower	Brass					

* CONSULTAR PARA ACABADOS DE COLOR

Installing instruction

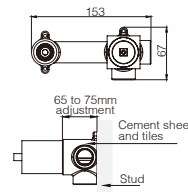
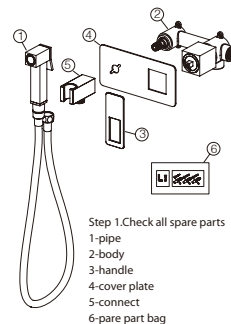

Step 1. Connect curved leg with the inlet pipe inside the wall

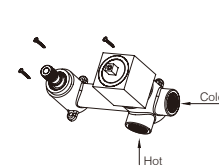

Step 2. Connect decorate cover to curved leg

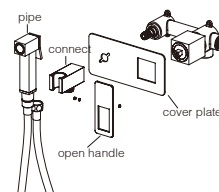

Step 3. Install shower faucet properly and connect to curved leg on the wall

FLOW RATE

Detalles	
FLOW RATE REF	BDC032-5
mixer water 0.1Mpa(L/MIN)	4.74
mixer water 0.3Mpa(L/MIN)	8.42
mixer water 0.5Mpa(L/MIN)	11.66
singer cold water 0.1Mpa(L/MIN)	4.98
singer cold water 0.3Mpa(L/MIN)	8.48
singer cold water 0.5Mpa(L/MIN)	11.46

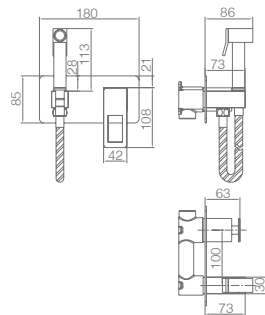
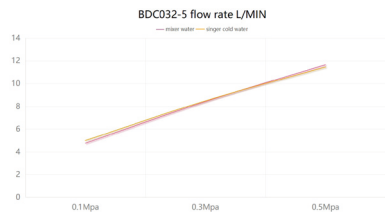

Product sizes (cm)	30*21*7
Weight (kg)	2.3
Guarantee	5 years
Max Preassure (bar)	5
Min Preassure (bar)	0.5
Optimum preassure (bar)	1-4 (Recommended 3)
Max. temperature	85°C
Min temperature	65°C

CERTIFIES

That all our products, provided that they are used in normal conditions or installed in accordance with current standards, are guaranteed against any manufacturing defect for a period of five years, except for products purchased before January 1, 2020, which will have the mand atory coverage of 2 years from the date of invoice.

Requirements and exclusions

Failure to comply with the instructions for assembly, use and maintenance of our products on the packaging and in our catalogue and published on our website: www.imexproducts.es, releases IMEX PRODUCTS, S.L. from any liability.

In any case, the acceptance of the defect by our technical department is necessary. In addition, transport costs will be charged only in the event that on IMEX PRODUCTS, S.L. technician determines the proper functioning of our products.

IMEX PRODUCTS, S.L. will decide to repair the product or replace it. It will be necessary to present the purchase invoice.

Assembly, maintenance or repairs carried out by non-specoalists re excluded from the warranty.

Wearing parts such as hoses, handles, seals, filters, aerators, etc. are not covered by the warranty.

