

**ÚNICO
SIMPLES E
PRÁCTICO**

IMEX
BATH EQUIPMENTS



2023 AVANCE

IMEX BATH EQUIPMENTS



IMEX PRODUCTS S.L é uma empresa situada em Picassent, Valência e dedicamo-nos ao fabrico e comercialização de rampas de duche e torneiras, começamos a nossa caminha em 2001, fornecendo materiais de casa de banho a empresas fabricantes do setor.

Com o tempo, desenvolvemos vários catálogos e fomos melhorando os nossos produtos até atingir desenhos e preços muitos competitivos no mercado.

Todos os produtos utilizados são de gama média-alta, usando as melhores matérias primas do mercado, como o latão S304 e S316 que nos fizeram ter representação nacional e internacional. Na Imex tentamos sempre estar à frente no desenho.

Os nossos valores como empresa são: a fabulosa relação qualidade-desenho-preço. E os nossos compromissos com os clientes são os seguintes:

- Conseguir o máximo de qualidade
- Ter presente que o cliente é a nossa principal preocupação e a sua satisfação o nosso principal objetivo
- Estar rodeados de grandes profissionais

Para isso tentamos adotar uma posição de melhora e inovação

O resultado de tudo vê-se refletido no catálogo que poderá ver a continuação.



PROFESSIONAL
IMEX
DESIGN



MONZA SERIE
CROMO





MONZA

CROMO

SERIE





Ref.: **BDM039**

Rampa de duche de aço inox S304 extensível 88/124cm.
 Chuveiro de teto aço inox S304 de Ø20 cm extra plano cromado e anti-calcário
 Suporte de chuveiro de mão regulável em altura
 Chuveiro de mão redondo de 1 posição
 Misturadora em latão cromado
 Caudal médio 12l/min
 Distribuidor incorporado
 Flexível PVC 1,5m
 Cartucho monocomando Ø35mm.

Cod.: **00173.00**



Ref.: **BTM039**

Rampa de duche de aço inox S304 extensível 88/124cm.
 Chuveiro de teto aço inox S304 de Ø20 cm extra plano cromado e anti-calcário
 Suporte de chuveiro de mão regulável em altura
 Chuveiro de mão redondo de 1 posição
 Misturadora termostática em latão cromado
 Caudal médio 12l/min
 Distribuidor incorporado
 Flexível PVC 1,5m
 Cartucho termostático TURN CLEAN SYSTEM

Cod.: **00207.00**



MONZA

CROMO

SERIE

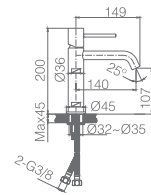

Ref.: **BDM039-1**

Misturadora lavatório cromada.
Corpo em latão cromado
Cartucho monocomando Ø25mm.
Flexíveis 3/8"

Cod.: **00054.00**

Grifería con certificación

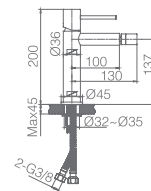

Ref.: **BDM039-2**

Misturadora bidé cromada
Corpo em latão cromado
Cartucho monocomando Ø25mm.
Flexíveis 3/8"

Cod.: **00054.00**

Grifería con certificación

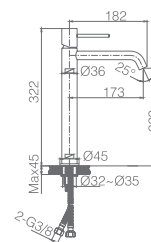

Ref.: **BDM039-3**

Misturadora lavatório alta cromada.
Corpo em latão cromado
Cartucho monocomando Ø25mm.
Flexíveis 3/8"

Cod.: **00073.00**

Grifería con certificación





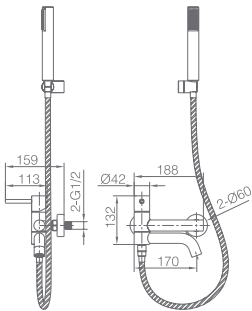

Ref.: **BDM039-4**

Misturadora de duche/banheira monocomando em latão cromado.
 Suporte para chuveiro de mão em ABS
 Chuveiro de mão redondo de 1 posição
 Caudal médio 12l/min
 Flexível reforçado 180cm.
 Cartucho monocomando cerâmico Ø35mm

Cod.: 00129.00



Grifería con certificación

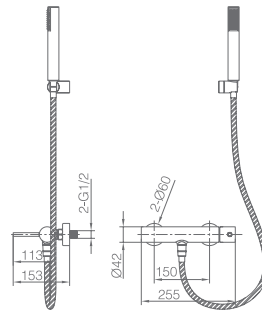

Ref.: **BDM039-5**

Misturadora duche monocomando em latão cromado.
 Suporte para chuveiro de mão em ABS
 Chuveiro de mão redondo de 1 posição
 Caudal médio 12l/min
 Flexível reforçado 180CM.
 Cartucho monocomando cerâmico Ø35mm

Cod.: 00102.00



Grifería con certificación



MONZA CROMO

SERIE







PROFESSIONAL
IMEX
DESIGN





Ref.: **GPM039**

Conjunto embutido 2 vias com chuv. de teto Ø25cm em latão cromado extra plano.
 Braço de parede latão cromado.
 Chuveiro de mão redondo 1 posição.
 Suporte para chuveiro de mão/toma de água.
 Caudal médio 20l/min.
 Flexível PVC 1.5 m.
 Cartucho monocomando cerâmico Ø35mm.

Cod.: 00175.00



Ref.: **GPT039**

Opção braço de teto latão cromado

Cod.: 00175.00



Ref.: **GTM039**

Conjunto embutido termostático 2 vias com chuv. de teto Ø25cm em latão cromado extra plano.
 Braço de parede latão cromado.
 Chuveiro de mão redondo 1 posição.
 Suporte para chuveiro de mão/toma de água.
 Caudal médio 20l/min.
 Flexível PVC 1.5 m.
 Cartucho termostático TURN CLEAN SYSTEM

Cod.: 00269.00



Ref.: **GTT039**

Opção braço de teto latão cromado

Cod.: 00269.00



MONZA

CROMO

SERIE



Ref.: GLM039

Misturadora monocomando lavatório embutida
Latão cromado.
Em duas partes independentes.
Corpo encastrado directamente na parede.
Sem caixa de registo.

Cod.: 00065.00

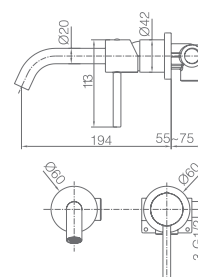



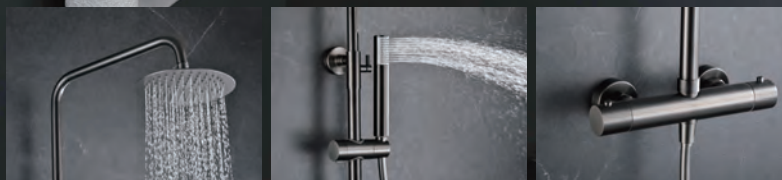

MONZA SERIE
BLACK GUN METAL

MONZA

BLACK GUN METAL
SERIE







Ref.: BDM039/BGM

Rampa de duche de aço inox S304 extensível 88/124cm.
 Chuveiro de teto aço inox S304 de Ø20 cm extra plano black gun metal e anti-calcário
 Suporte de chuveiro de mão regulável em altura
 Chuveiro de mão redondo de 1 posição
 Misturadora em latão black gun metal
 Caudal médio 12l/min
 Distribuidor incorporado
 Flexível PVC 1,5m
 Cartucho monocomando cerâmico Ø35mm.

Cod.: 00261.00



Ref.: BTM039/BGM

Rampa de duche de aço inox S304 extensível 88/124cm.
 Chuveiro de teto aço inox S304 de Ø20 cm extra plano black gun metal e anti-calcário
 Suporte de chuveiro de mão regulável em altura
 Chuveiro de mão redondo de 1 posição
 Misturadora termostática em latão black gun metal
 Caudal médio 12l/min
 Distribuidor incorporado
 Flexível PVC 1,5m
 Cartucho termostático TURN CLEAN SYSTEM

Cod.: 00296.00



MONZA

BLACK GUN METAL

SERIE

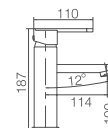

Ref.: **BDM039-1BGM**

Misturadora lavatório black gun metal.
Corpo em latão cromado
Cartucho monocomando Ø25mm.
Flexíveis 3/8"

Cod.: **00067.00**

Grifería con certificación

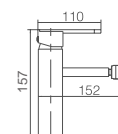

Ref.: **BDM039-2BGM**

Misturadora bidé black gun metal
Corpo em latão cromado
Cartucho monocomando Ø25mm.
Flexíveis 3/8"

Cod.: **00066.00**

Grifería con certificación

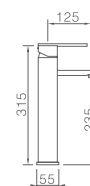

Ref.: **BDM039-3BGM**

Misturadora lavatório alta black gun metal.
Corpo em latão cromado
Cartucho monocomando Ø25mm.
Flexíveis 3/8"

Cod.: **00086.00**

Grifería con certificación



MONZA

BLACK GUN METAL

SERIE



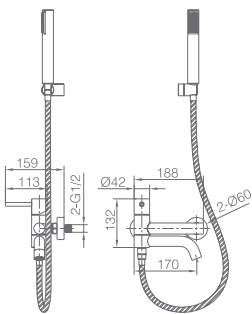

Ref.: **BDM039-4BGM**

Misturadora de duche/banheira monocomando em latão black gun metal.
 Suporte para chuveiro de mão em ABS
 Chuveiro de mão redondo de 1 posição
 Caudal médio 12l/min
 Flexível PVC 180cm.
 Cartucho monocomando cerâmico Ø35mm

Cod.: 00169.00

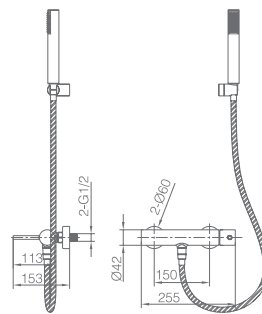

Ref.: **BDM039-5BGM**

Misturadora duche monocomando em latão black gun metal.
 Suporte para chuveiro de mão em ABS
 Chuveiro de mão redondo de 1 posição
 Caudal médio 12l/min
 Flexível PVC 180CM.
 Cartucho monocomando cerâmico Ø35mm

Cod.: 00134.00





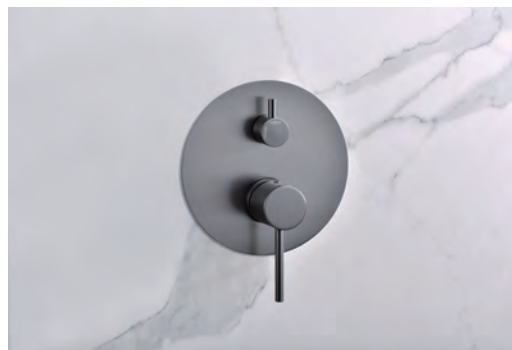

MONZA

BLACK GUN METAL

SERIE





PVD

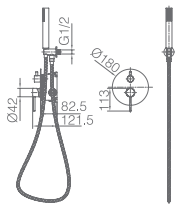
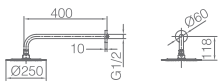

Ref.: **GPM039/BGM**

Conjunto embutido 2 vias com chuv. de teto Ø25cm em latão black gun metal extra plano.
Braço de parede latão black gun metal.
Chuveiro de mão redondo 1 posição.
Suporte para chuveiro de mão/toma de água.
Caudal médio 20l/min.
Flexível PVC 1.5 m.
Cartucho monocomando cerâmico Ø35mm.

Cod.: 00239.00



Ref.: **GPT039/BGM**

Opção braço de teto latão black gun metal.

Cod.: 00239.00

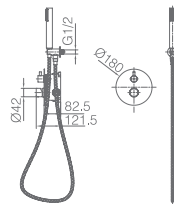
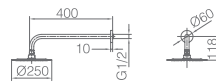

Ref.: **GTM039/BGM**

Conjunto embutido termostático 2 vias com chuv. de teto Ø25cm em latão black gun metal extra plano.
Braço de parede latão black gun metal.
Chuveiro de mão redondo 1 posição.
Suporte para chuveiro de mão/toma de água.
Caudal médio 20l/min.
Flexível PVC 1.5 m.
Cartucho termostático TURN CLEAN SYSTEM

Cod.: 00334.00



Ref.: **GTT039/BGM**

Opção braço de teto latão black gun metal.

Cod.: 00334.00

MONZA

BLACK GUN METAL

SERIE



Ref.: GLM039/BGM

Misturadora monocomando lavatório embutida
Latão black gun metal.
Em duas partes independentes.
Corpo encastrado directamente na parede.
Sem caixa de registo.

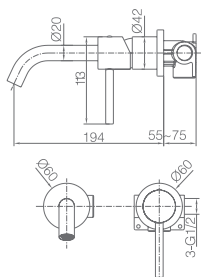

Cod.: 00079.00







MONZA SERIE
PRETO MATE





MONZA

PRETO MATE

SERIE

ELECTROFÓRESIS





Ref.: BDM039/NG

Rampa de duche de aço inox S304 extensível 88/124cm.
 Chuveiro de teto aço inox S304 de Ø20 cm extra plano preto mate e anti-calcário
 Suporte de chuveiro de mão regulável em altura
 Chuveiro de mão redondo de 1 posição
 Misturadora em latão preto mate
 Caudal médio 12l/min
 Distribuidor incorporado
 Flexível PVC 1,5m
 Cartucho monocomando cerâmico Ø35mm

Cod.: 00192.00



Ref.: BTM039/NG

Rampa de duche de aço inox S304 extensível 88/124cm.
 Chuveiro de teto aço inox S304 de Ø20 cm extra plano preto mate e anti-calcário
 Suporte de chuveiro de mão regulável em altura
 Chuveiro de mão redondo de 1 posição
 Misturadora termostática em latão preto mate
 Caudal médio 12l/min
 Distribuidor incorporado
 Flexível PVC 1,5m
 Cartucho termostático TURN CLEAN SYSTEM

Cod.: 00239.00



MONZA

PRETO MATE

SERIE

ELECTROFÓRESIS

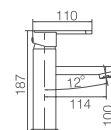
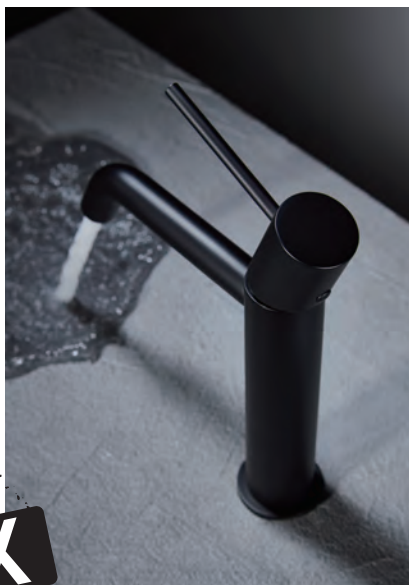

Ref.: **BDM039-1NG**

Misturadora lavatório preto mate.
Corpo em latão cromado
Cartucho monocomando Ø25mm.
Flexíveis 3/8"

Cod.: **00059.00**

Grifería con certificación

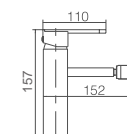

Ref.: **BDM039-2NG**

Misturadora bidé preto mate
Corpo em latão cromado
Cartucho monocomando Ø25mm.
Flexíveis 3/8"

Cod.: **00058.00**

Grifería con certificación

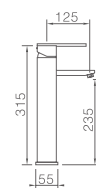

Ref.: **BDM039-3NG**

Misturadora lavatório alta preto mate.
Corpo em latão cromado
Cartucho monocomando Ø25mm.
Flexíveis 3/8"

Cod.: **00077.00**

Grifería con certificación



MONZA

PRETO MATE

SERIES

ELECTROFÓRESIS



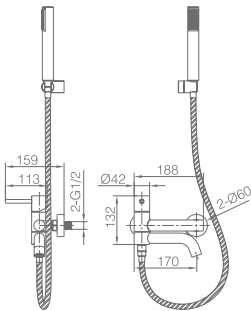

Ref.: **BDM039-4NG**

Misturadora de duche/banheira monocomando em latão preto mate.
 Suporte para chuveiro de mão em ABS
 Chuveiro de mão redondo de 1 posição
 Caudal médio 12l/min
 Flexível PVC 180cm.
 Cartucho monocomando cerâmico Ø35mm

Cod.: 00140.00



Grifería con certificación

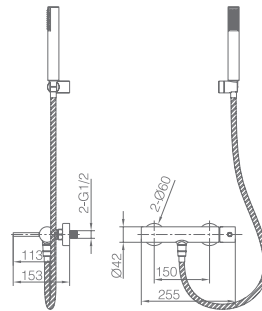

Ref.: **BDM039-5NG**

Misturadora duche monocomando em latão preto mate.
 Suporte para chuveiro de mão em ABS
 Chuveiro de mão redondo de 1 posição
 Caudal médio 12l/min
 Flexível PVC 180CM.
 Cartucho monocomando cerâmico Ø35mm

Cod.: 00110.00



Grifería con certificación











Ref.: **GPM039/NG**

Conjunto embutido 2 vias com chuv. de teto Ø25cm em latão preto mate extra plano.
Braço de parede latão preto mate.
Chuveiro de mão redondo 1 posição.
Suporte para chuveiro de mão/toma de água.
Caudal médio 20l/min.
Flexível PVC 1.5 m.
Cartucho monocomando cerâmico Ø35mm.

Cod.: **00193.00**



Ref.: **GPT039/NG**

Opção braço de teto latão preto mate.

Cod.: **00193.00**



Ref.: **GTM039/NG**

Conjunto embutido termostático 2 vias com chuv. de teto Ø25cm em latão preto mate extra plano.
Braço de parede latão preto mate.
Chuveiro de mão redondo 1 posição.
Suporte para chuveiro de mão/toma de água.
Caudal médio 20l/min.
Flexível PVC 1.5 m.
Cartucho termostático TURN CLEAN SYSTEM

Cod.: **00287.00**



Ref.: **GTT039/NG**

Opção braço de teto latão preto mate.

Cod.: **00287.00**

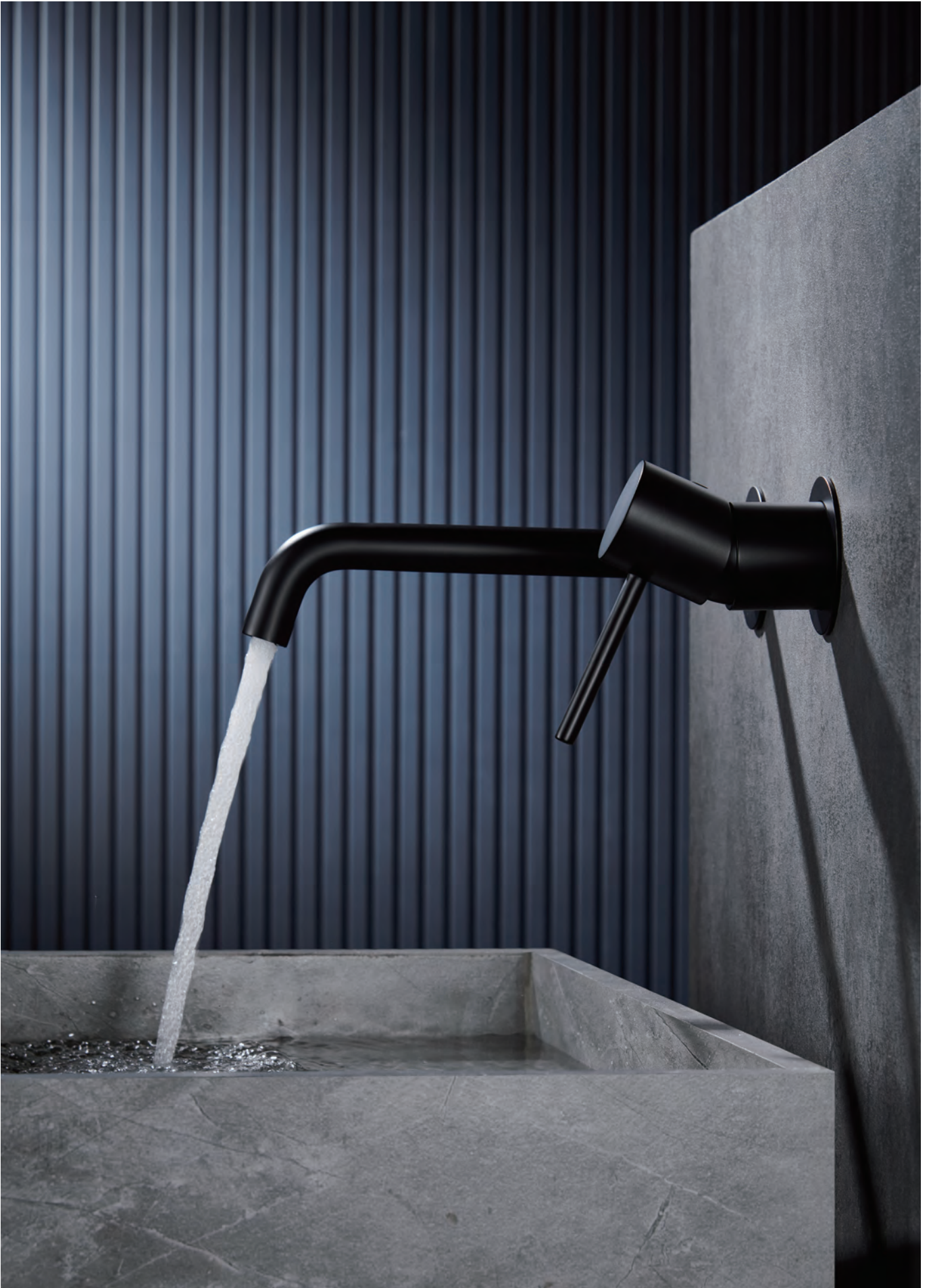

MONZA

PRETO MATE

SERIE

ELECTROFÓRESIS



Ref.: **GLM039/NG**

Misturadora monocomando lavatório embutida
Latão preto mate.
Em duas partes independentes.
Corpo encastrado directamente na parede.
Sem caixa de registo.

Cod.: 00069.00

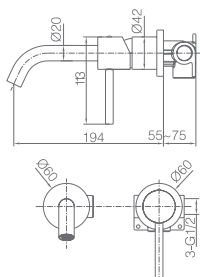

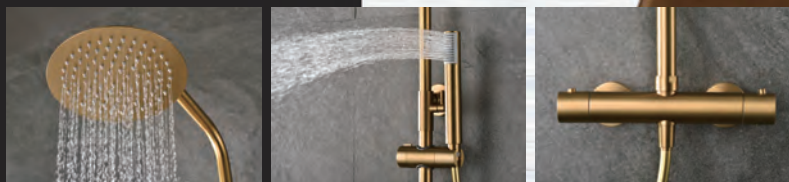

MONZA SERIE
OURO ESCOVADO





MONZA

OURO ESCOVADO

SERIE

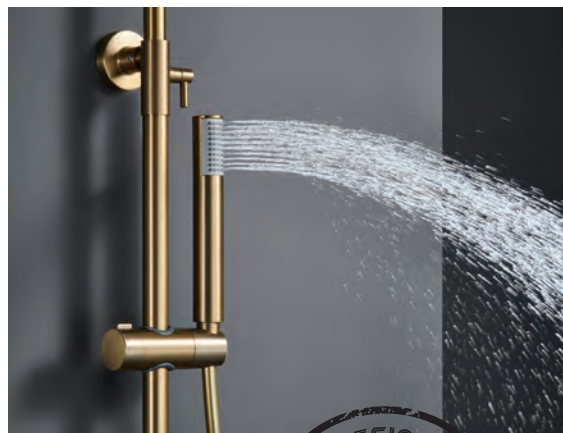

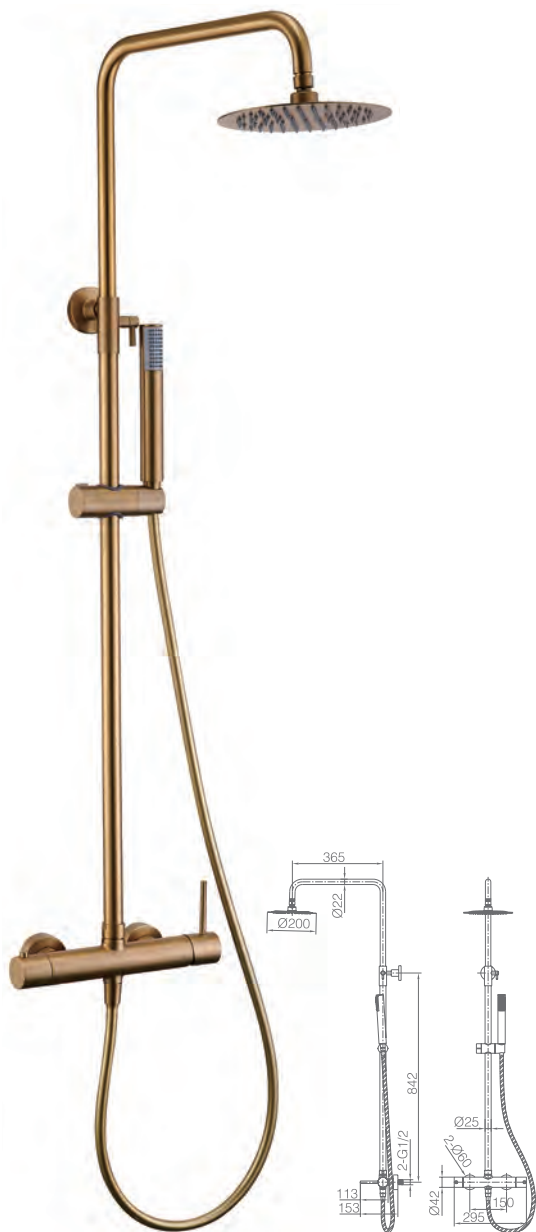

Ref.: **BDM039/OC**

Rampa de duche de aço inox S304 extensível 88/124cm.
 Chuveiro de teto aço inox S304 de Ø20 cm extra plano ouro escovado e anti-calcário
 Suporte de chuveiro de mão regulável em altura
 Chuveiro de mão redondo de 1 posição
 Misturadora em latão ouro escovado
 Caudal médio 12l/min
 Distribuidor incorporado
 Flexível PVC 1,5m
 Cartucho monocomando cerâmico Ø35mm

Cod.: 00252.00



Ref.: **BTM039/OC**

Rampa de duche de aço inox S304 extensível 88/124cm.
 Chuveiro de teto aço inox S304 de Ø20 cm extra plano ouro escovado e anti-calcário
 Suporte de chuveiro de mão regulável em altura
 Chuveiro de mão redondo de 1 posição
 Misturadora termostática em latão ouro escovado
 Caudal médio 12l/min
 Distribuidor incorporado
 Flexível PVC 1,5m
 Cartucho termostático TURN CLEAN SYSTEM

Cod.: 00289.00



MONZA

OURO ESCOVADO

SERIE

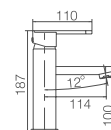

Ref.: **BDM039-10C**

Misturadora lavatório ouro mate.
Corpo em latão cromado
Cartucho monocomando Ø25mm.
Flexíveis 3/8"

Cod.: 00067.00

Griferia con certificación

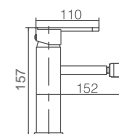

Ref.: **BDM039-20C**

Misturadora bidé ouro mate
Corpo em latão cromado
Cartucho monocomando Ø25mm.
Flexíveis 3/8"

Cod.: 00066.00

Griferia con certificación

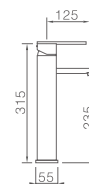

Ref.: **BDM039-30C**

Misturadora lavatório alta ouro mate.
Corpo em latão cromado
Cartucho monocomando Ø25mm.
Flexíveis 3/8"

Cod.: 00086.00

Griferia con certificación





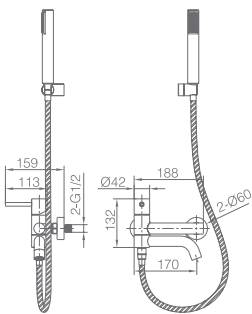

Ref.: **BDM039-4OC**

Misturadora de duche/banheira monocomando em latão ouro escovado.
 Suporte para chuveiro de mão em ABS
 Chuveiro de mão redondo de 1 posição
 Caudal médio 12l/min
 Flexível PVC 180cm.
 Cartucho monocomando cerâmico Ø35mm

Cod.: 00161.00

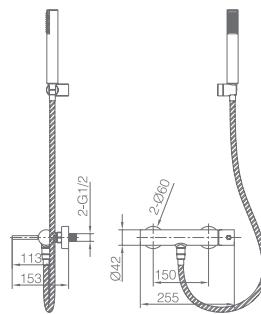

Ref.: **BDM039-5OC**

Misturadora duche monocomando em latão ouro escovado.
 Suporte para chuveiro de mão em ABS
 Chuveiro de mão redondo de 1 posição
 Caudal médio 12l/min
 Flexível PVC 180CM.
 Cartucho monocomando cerâmico Ø35mm

Cod.: 00127.00



MONZA

OURO ESCOVADO

SERIE

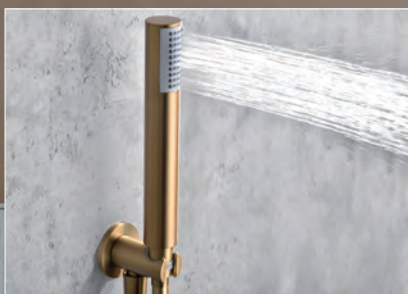





PVD



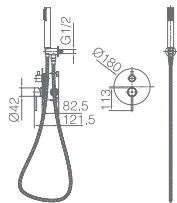
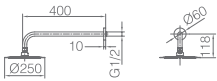

Ref.: **GPM039/OC**

Conjunto embutido 2 vias com chuv. de teto Ø25cm em latão ouro escovado extra plano.
Braço de parede latão ouro escovado.
Chuveiro de mão redondo 1 posição.
Suporte para chuveiro de mão/toma de água.
Caudal médio 20l/min.
Flexível PVC 1.5 m.
Cartucho monocomando cerâmico Ø35mm.

Cod.: **00239.00**

Grifería con certificación



Ref.: **GPT039/OC**

Opção braço de teto latão ouro escovado.

Cod.: **00239.00**

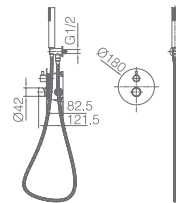
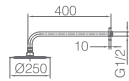

Ref.: **GTM039/OC**

Conjunto embutido termostático 2 vias com chuv. de teto Ø25cm em latão ouro escovado extra plano.
Braço de parede latão ouro escovado.
Chuveiro de mão redondo 1 posição.
Suporte para chuveiro de mão/toma de água.
Caudal médio 20l/min.
Flexível PVC 1.5 m.
Cartucho termostático TURN CLEAN SYSTEM

Cod.: **00334.00**

Grifería con certificación



Ref.: **GTT039/OC**

Opção braço de teto latão ouro escovado.

Cod.: **00334.00**



MONZA

OURO ESCOVADO

SERIE



Ref.: **GLM039/OC**

Misturadora monocomando lavatório embutida
 Latão ouro escovado.
 Em duas partes independentes.
 Corpo encastrado directamente na parede.
 Sem caixa de registo.

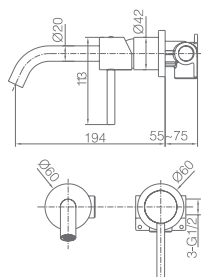

Cod.: 00079.00







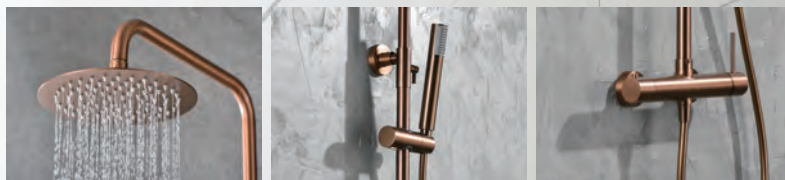

MONZA SERIE
OURO ROSA ESCOVADO

MONZA

OURO ROSA ESCOVADO

SERIE







Ref.: BDM039/ORC

Rampa de duche de aço inox S304 extensível 88/124cm.
 Chuveiro de teto aço inox S304 de Ø20 cm extra plano ouro rosa escovado e anti-calcário
 Suporte de chuveiro de mão regulável em altura
 Chuveiro de mão redondo de 1 posição
 Misturadora em latão ouro rosa escovado
 Caudal médio 12l/min
 Distribuidor incorporado
 Flexível PVC 1,5m
 Cartucho monocomando cerâmico Ø35mm

Cod.: 00261.00



Ref.: BTM039/ORC

Rampa de duche de aço inox S304 extensível 88/124cm.
 Chuveiro de teto aço inox S304 de Ø20 cm extra plano ouro rosa escovado e anti-calcário
 Suporte de chuveiro de mão regulável em altura
 Chuveiro de mão redondo de 1 posição
 Misturadora termostática em latão ouro rosa escovado
 Caudal médio 12l/min
 Distribuidor incorporado
 Flexível PVC 1,5m
 Cartucho termostático TURN CLEAN SYSTEM

Cod.: 00296.00



MONZA

OURO ROSA ESCOVADO

SERIE

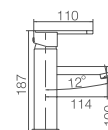

Ref.: **BDM039-10RC**

Misturadora lavatório ouro rosa escovado.
Corpo em latão cromado
Cartucho monocomando Ø25mm.
Flexíveis 3/8"

Griferia con certificación



Cod.: **00067.00**

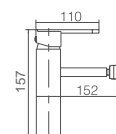

Ref.: **BDM039-20RC**

Misturadora bidé ouro rosa escovado.
Corpo em latão cromado
Cartucho monocomando Ø25mm.
Flexíveis 3/8"

Griferia con certificación



Cod.: **00066.00**

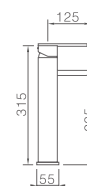

Ref.: **BDM039-30RC**

Misturadora lavatório alta ouro rosa escovado.
Corpo em latão cromado
Cartucho monocomando Ø25mm.

Griferia con certificación



Cod.: **00086.00**



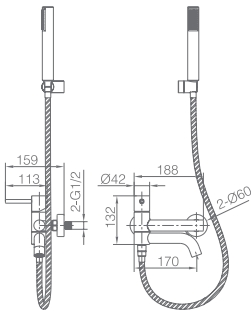
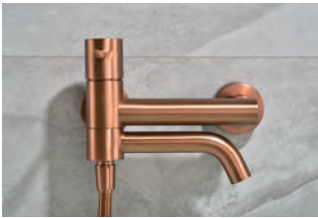

Ref.: **BDM039-4ORC**

Misturadora de duche/banheira monocomando em latão ouro rosa escovado.
 Suporte para chuveiro de mão em ABS
 Chuveiro de mão redondo de 1 posição
 Caudal médio 12l/min
 Flexível PVC 180cm.
 Cartucho monocomando cerâmico Ø35mm

Cod.: **00169.00**

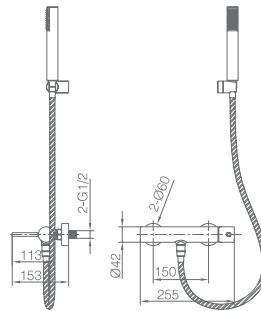

Ref.: **BDM039-5ORC**

Misturadora duche monocomando em latão ouro rosa escovado.
 Suporte para chuveiro de mão em ABS
 Chuveiro de mão redondo de 1 posição
 Caudal médio 12l/min
 Flexível PVC 180CM.
 Cartucho monocomando cerâmico Ø35mm

Cod.: **00134.00**



MONZA

OURO ROSA ESCOVADO

SERIE







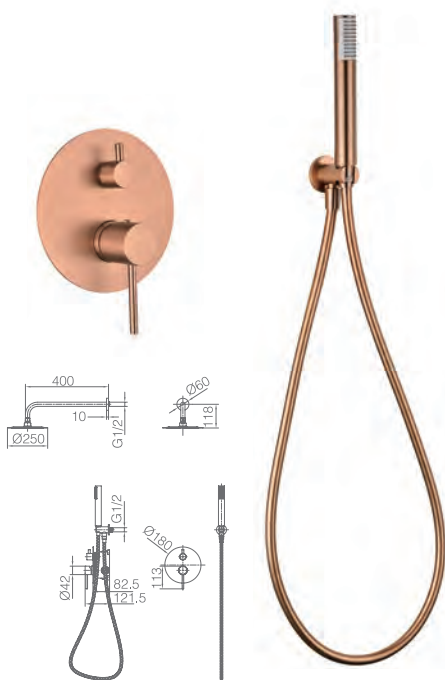

Ref.: **GPM039/ORC**

Conjunto embutido 2 vias com chuv. de teto Ø25cm em latão ouro rosa escovado extra plano.
Braço de parede latão ouro rosa escovado.
Chuveiro de mão redondo 1 posição.
Suporte para chuveiro de mão/toma de água.
Caudal médio 20l/min.
Flexível PVC 1.5 m.
Cartucho monocomando cerâmico Ø35mm.

Cod.: 00239.00



Ref.: **GPT039/ORC**

Opção braço de teto latão ouro rosa escovado.

Cod.: 00239.00

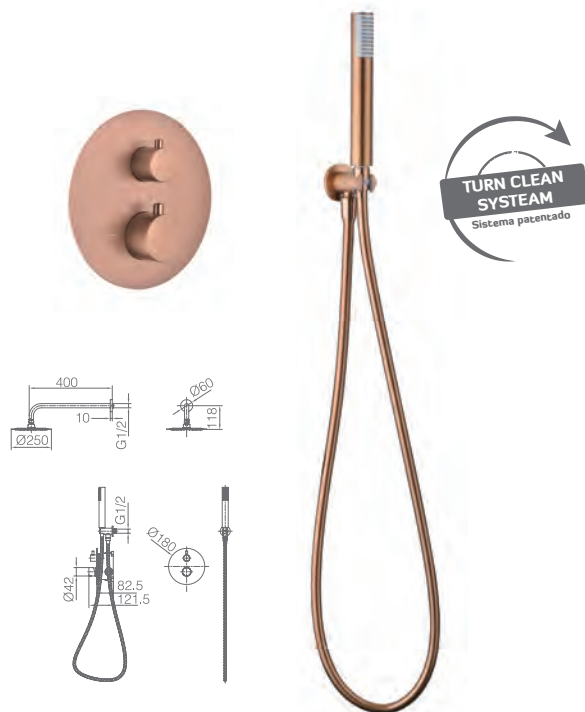

Ref.: **GTM039/ORC**

Conjunto embutido termostático 2 vias com chuv. de teto Ø25cm em latão ouro rosa escovado extra plano.
Braço de parede latão ouro rosa escovado.
Chuveiro de mão redondo 1 posição.
Suporte para chuveiro de mão/toma de água.
Caudal médio 20l/min.
Flexível PVC 1.5 m.
Cartucho termostático TURN CLEAN SYSTEM

Cod.: 00334.00



Ref.: **GTT039/ORC**

Opção braço de teto latão ouro rosa escovado.

Cod.: 00334.00

MONZA

OURO ROSA ESCOVADO

SERIE





Ref.: **GLM039/ORC**

Misturadora monocomando lavatório embutida
Latão ouro rosa escovado.
Em duas partes independentes.
Corpo encastrado directamente na parede.
Sem caixa de registo.

Cod.: **00079.00**

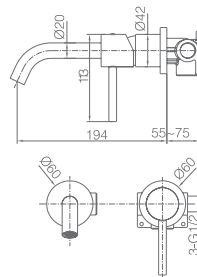

MUNICH

SERIE
KIT BIDÉ EMBUTIDO





MUNICH

CROMO

SERIE



Ref.: RDM001

Torneira embutida de bidé
Água quente e fria
Chuveirinho de uma posição
Latão cromado
Bicha aço inox reforçado de 100cm

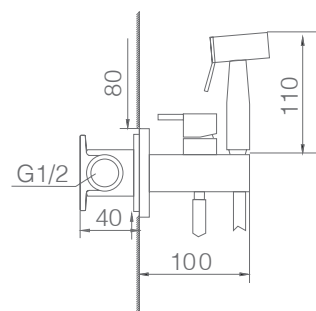

Cod.: 00087.50





MUNICH

BLACK GUN METAL

SERIE



Ref.: RDM001/BGM

Torneira embutida de bidé
Água quente e fria
Chuveirinho de uma posição
Latão black gun metal
Bicha PVC 100cm

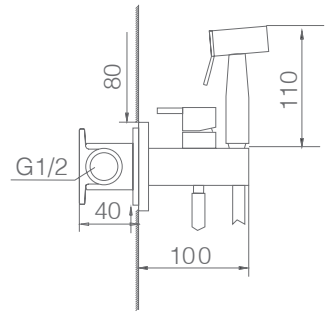

Cod.: 00129.00



MUNICH

PRETO MATE

SERIE

ELECTROFÓRESIS

Ref.: RDM001/NG

Torneira embutida de bidé
Água quente e fria
Chuveirinho de uma posição
Latão preto mate.
Bicha PVC 100cm

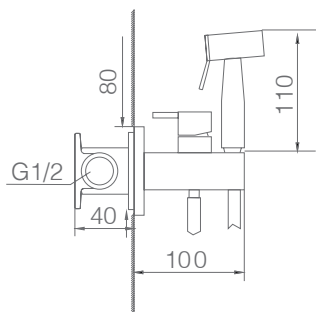

Cod.: 00099.00







MUNICH

OURO ESCOVADO

SERIE

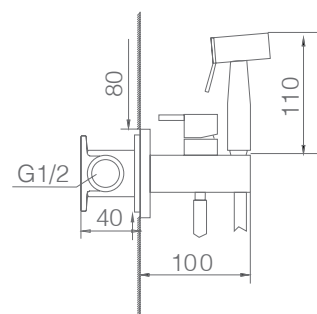
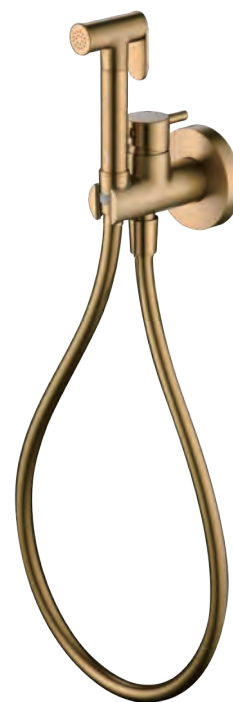

Ref.: RDM001/OC

Torneira embutida de bidé
Água quente e fria
Chuveirinho de uma posição
Latão ouro escovado
Bicha PVC 100cm

Cod.: 00126.00



MUNICH

OURO ROSA ESCOVADO

SERIE

Ref.: RDM001/ORC

Torneira embutida de bidé
Água quente e fria
Chuveirinho de uma posição
Latão ouro rosa escovado
Bicha PVC 100cm

Cod.: 00129.00

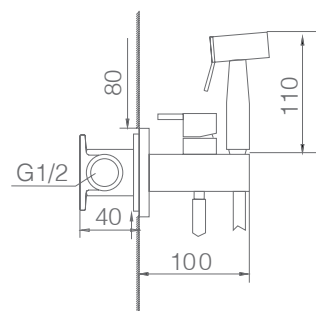
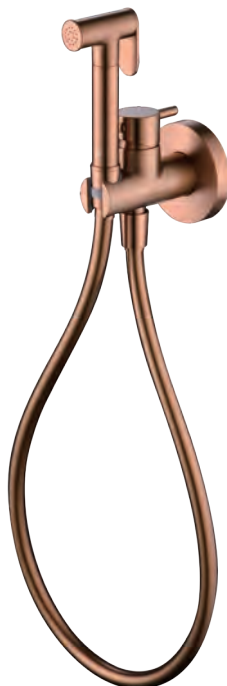



CÓRCEGA

SERIE

TORNEIRA EXTERNA DE BANHEIRA



CÓRCEGA

CROMO

SERIE

Ref.: BBECO1

Torneira externa de banheira latão cromado
Cartucho cerâmico Ø35mm
Chuveiro de mão redondo, 1 posição.
Bicha PVC.
Caixa de embutir no chão.

Cod.: 00380.50

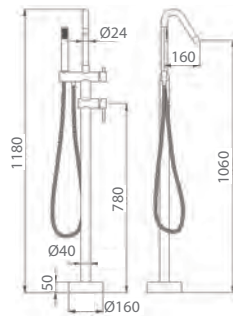





CÓRCEGA

BLACK GUN METAL

SERIE

Ref.: **BBECO1/BGM**

Torneira externa de banheira latão black gun metal
Cartucho cerâmico Ø35mm
Chuveiro de mão redondo, 1 posição.
Bicha PVC.
Caixa de embutir no chão.

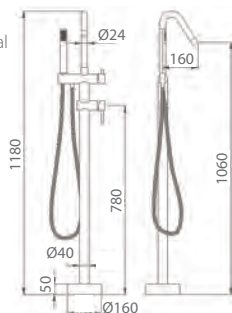

Cod.: 00475.00



CÓRCEGA

PRETO MATE

SERIE

Ref.: BBECO1/NG

Torneira externa de banheira latão preto mate.
Cartucho cerâmico Ø35mm
Chuveiro de mão redondo, 1 posição.
Bicha PVC.
Caixa de embutir no chão.

Cod.: 00440.00



ELECTROFÓRESIS

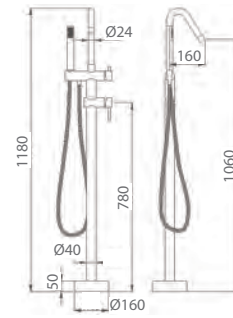



CÓRCEGA

OURO ESCOVADO

SERIE

Ref.: BBECO1/OC

Torneira externa de banheira latão ouro escovado.

Cartucho cerâmico Ø35mm

Chuveiro de mão redondo, 1 posição.

Bicha PVC.

Caixa de embutir no chão.

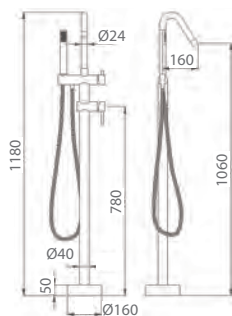

Cod.: 00475.00







CÓRCEGA

OURO ROSA ESCOVADO

SERIE

Ref.: BBECO1/ORC

Torneira externa de banheira latão ouro rosa escovado.
Cartucho cerâmico Ø35mm
Chuveiro de mão redondo, 1 posição.
Bicha PVC.
Caixa de embutir no chão.

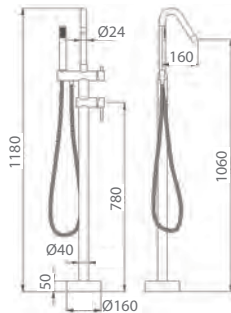

Cod.: 00475.00

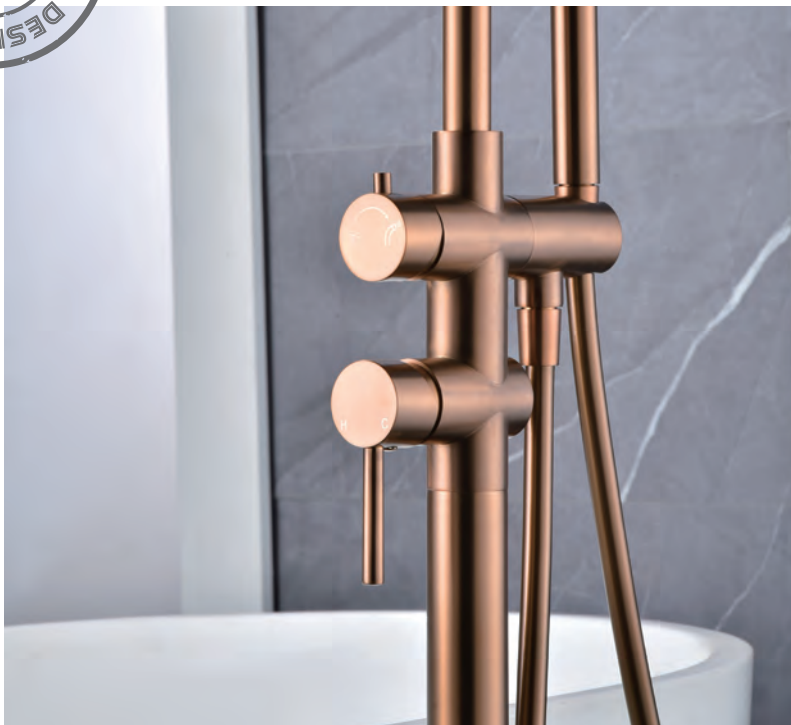

COMPLEMENTOS

VALVULAS

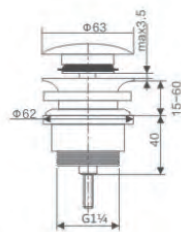

Ref.: VCC001

Compatível com todos os lavatórios com ou sem furo ladrão
Sistema de abertura e fecho garantido para 20000 ciclos
Rosca inferior de Ø1 ¼"
Fabricado em latão cromado
Montagem rápida e simples

Cod.: 00010.50

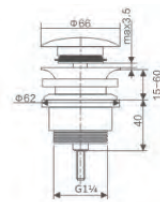

Ref.: VCC008(preto mate)

Compatível com todos os lavatórios com ou sem furo ladrão
Sistema de abertura e fecho garantido para 20000 ciclos
Rosca inferior de Ø1 ¼"
Fabricado em latão preto mate
Montagem rápida e simples

Cod.: 00014.50

SISTEMA LACADO
ELECTROFORESIS

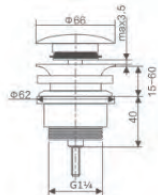

Ref.: VCC014 (ouro escovado)

PVD

Compatível com todos os lavatórios com ou sem furo ladrão
Sistema de abertura e fecho garantido para 20000 ciclos
Rosca inferior de Ø1 ¼"
Fabricado em latão e zamak
Acabado PVD ouro escovado.
Montagem rápida e simples

Cod.: 00019.90

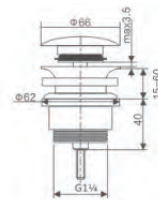

Ref.: VCC023 (ouro rosa escovado)

PVD

Compatível com todos os lavatórios com ou sem furo ladrão
Sistema de abertura e fecho garantido para 20000 ciclos
Rosca inferior de Ø1 ¼"
Fabricado em latão e zamak
Acabado PVD ouro rosa escovado.
Montagem rápida e simples

Cod.: 00019.90

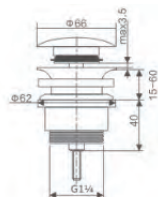

Ref.: VCC018 (black gun metal)

Compatível com todos os lavatórios com ou sem furo ladrão
Sistema de abertura e fecho garantido para 20000 ciclos
Rosca inferior de Ø1 ¼"
Fabricado em latão e zamak
Acabado PVD black gun metal.
Montagem rápida e simples

Cod.: 00019.90

PVD



VALVULAS (PVC)



SISTEMA LACADO
ELECTROFORESIS

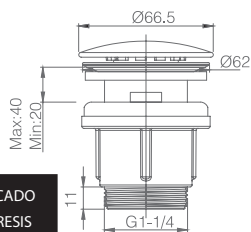

Ref.: VCC019 (preto mate)

Compatível com todos os lavatórios com ou sem furo ladrão
Sistema de abertura e fecho garantido para 20000 ciclos
Rosca inferior de Ø1 ¼"
Fabricado em PVC e aço S304 preto mate
Montagem rápida e simples

Cod.: 00010.00

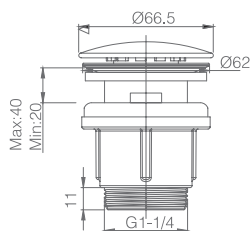

Ref.: VCC021 (ouro rosa escovado)

Compatível com todos os lavatórios com ou sem furo ladrão
Sistema de abertura e fecho garantido para 20000 ciclos
Rosca inferior de Ø1 ¼"
Fabricado em PVC e aço S304 ouro rosa escovado
Montagem rápida e simples

Cod.: 00011.00

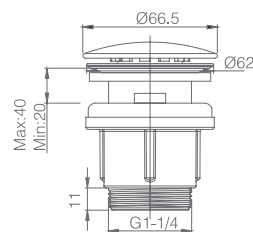

Ref.: VCC020 (ouro escovado)

Compatível com todos os lavatórios com ou sem furo ladrão
Sistema de abertura e fecho garantido para 20000 ciclos
Rosca inferior de Ø1 ¼"
Fabricado em PVC e aço S304 ouro escovado
Montagem rápida e simples

Cod.: 00011.00

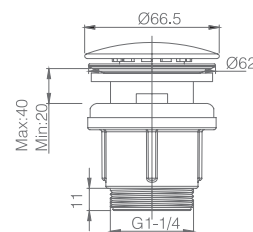

Ref.: VCC022 (black gun metal)

Compatível com todos os lavatórios com ou sem furo ladrão
Sistema de abertura e fecho garantido para 20000 ciclos
Rosca inferior de Ø1 ¼"
Fabricado em PVC e aço S304 black gun metal
Montagem rápida e simples

Cod.: 00011.00

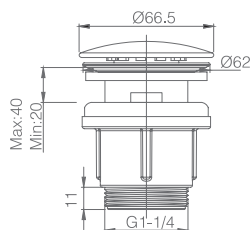

Ref.: VCC009

Compatível com todos os lavatórios com ou sem furo ladrão
Sistema de abertura e fecho garantido para 20000 ciclos
Rosca inferior de Ø1 ¼"
Fabricado em PVC e aço S304 cromo
Montagem rápida e simples

Cod.: 00008.50



SIFONES



Ref.: **SCL002** Cod.: **00017.50**

Sifon visto redondo.
Base desmontable, fácil limpieza.
Material : Acero s304 y zamak
Acababo : Cromado



Ref.: **SCL002/BGM** Cod.: **00035.00**

Sifon visto redondo.
Base desmontable, fácil limpieza.
Material : Acero s304 y zamak
Acababo : Black gun metal



Ref.: **SCL002/ORC** Cod.: **00035.00**

Sifon visto redondo.
Base desmontable, fácil limpieza.

Material : Acero s304 y zamak
Acababo : Ouro rosa escovado



ELECTROFORESIS

Ref.: **SCL002/NG** Cod.: **00023.00**

Sifon visto redondo.
Base desmontable, fácil limpieza.
Material : Acero s304 y zamak
Acababo : Preto mate.

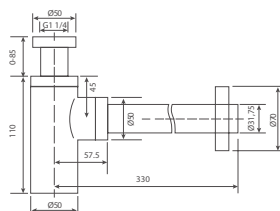

Ref.: **SCL002/OC** Cod.: **00035.00**

Sifon visto redondo.
Base desmontable, fácil limpieza.
Material : Acero s304 y zamak
Acababo : Ouro cepillado



Ref.: **1EXP0002-B**

CONDIÇÕES GERAIS DE VENDA

ENTREGAS

Verifique a mercadoria no momento da sua receção. Não serão aceites reclamações relativas a mercadorias não verificadas no momento da entrega. A empresa de transportes indicará tal situação na guia de transporte.

DEVOLUÇÕES

Em caso de devolução, descreva com clareza o motivo da mesma.

A Imex ou o seu representante apenas aceitarão aquelas devoluções que preencham os seguintes requisitos:

- O material deverá apresentar algum tipo de defeito de fabrico.
- A embalagem deverá estar em perfeitas condições, caso assim não seja será aplicada uma penalização de 10% do valor dessa mercadoria como despesas de receção, revisão e manuseamento.

FORMA DE PAGAMENTO

Transferência bancária ou cheque a 30 dias

Qualquer atraso que se produza terá como consequência a interrupção do serviço bem como o débito das custas bancárias e outras despesas relacionadas.

TRIBUNAIS

Em caso de litígio, ambas as partes submeter-se-ão aos tribunais de Torrent (Espanha) caso tenha sido o fabricante a faturar ou aos tribunais de Vila do Conde caso tenha sido o distribuidor a faturar.

TRANSPORTE

Serão cobrados 7€ de portes nos pedidos que não tenham valor superior a 200€.

ACTUALIZAÇÃO E MANUTENÇÃO DAS COLEÇÕES

Em ocasiões, alguns dos produtos fornecidos pela IMEX PRODUCTS, S.L., podem apresentar alterações em algumas das suas peças em relação às imagens do catálogo atual.

IMEX PRODUCTOS S.L., reserva-se o direito de realizar ditas alterações nos seus modelos sendo sempre em busca de melhorias tanto na imagem como na funcionalidade do produto, além das condições de venda.

CONSELHOS DE LIMPEZA E MANUTENÇÃO

Na imex products aconselhamos para realizar a limpeza dos nossos produtos, em cores preto mate ou branco mate, que se utilizem produtos não corrosivos e com um PH neutro, evitando assim, danificar os produtos.

Seguindo as recomendações do fabricante, aconselhamos utilizar pano de microfibra no processo de limpeza e finalizar com a secagem dos produtos para assim alargar a vida dos mesmos.

Video demonstrativo





IMEX PRODUCTS, S.L.

Pol. Ind. Picassent
C/ 6 parcela 11
46220 Picasset (Valencia)- Sapain
C.I.F.:B-98301732

AT.CLIENT:

Tel: +34 96 065 12 74
Tel: +34 96 156 63 87
Tel: +34 630 402 947

www.imexproducts.es



Mails:

(Pedidos) imex@imexproducts.es
(Consultas) consultas@imexproducts.es
(Servicio Técnico) sat@imexproducts.es
(Exportación) export@imexproducts.es