

MANUAL FOR FLOORING FAUCET

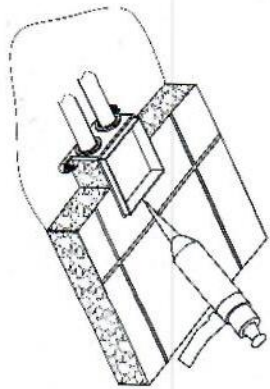

13. Install flooring and seal it.
13. instalar pisos y sellarlo

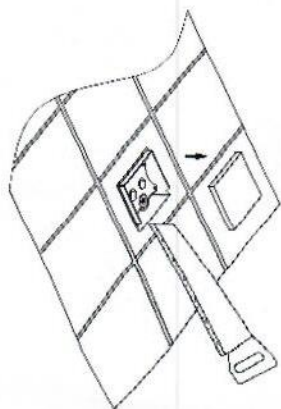

14. Cut extra plastic less than 4mm on the floor.
14. Corte plástico extra de menos de 4 mm en el suelo



15. Connect the water pipe and fix the vertical body.
15. Conecte el tubo y fije el cuerpo del grifo vertical

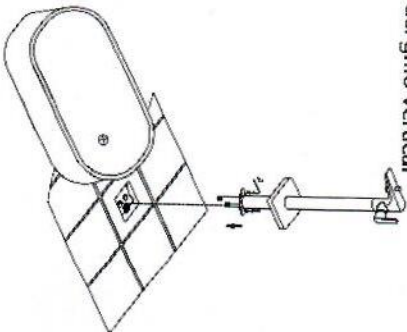

17. Adjust the direction with bath, screw it to the fixed part and close the cover.
17. ajuste la dirección con el baño, atorníllela a la parte fija y cierre la tapa

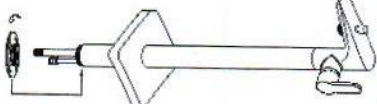

16. Put the cover and screw it.
16. pon la tapa y atorníllela

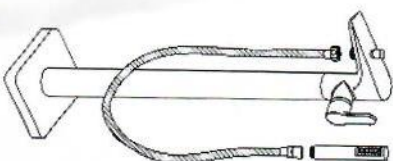

18. Connect the shower with tube.
18. conectar la ducha con manguera

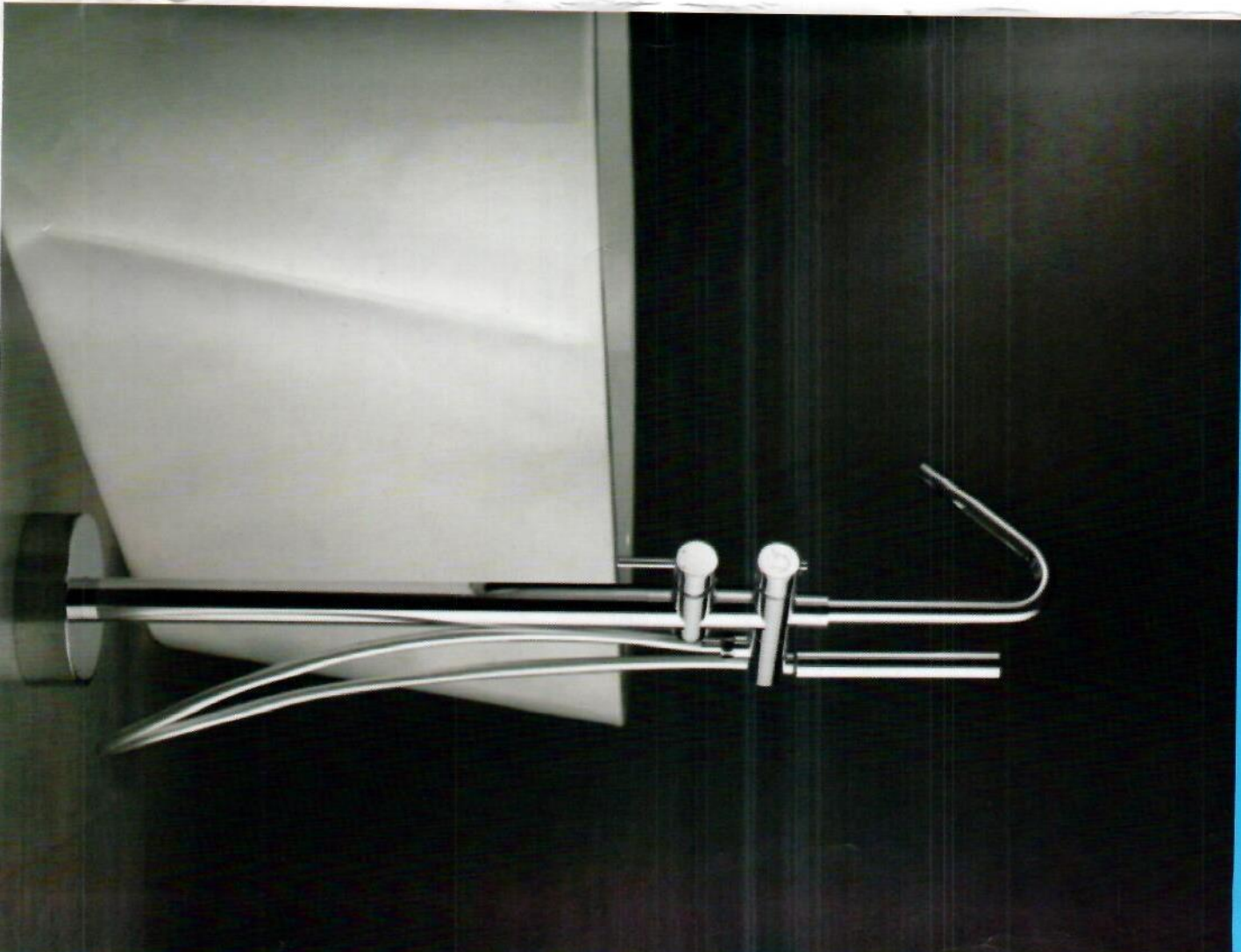

INSTALLATION STEPS:

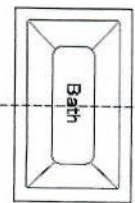

1. Put the inside part beside the bath and align it with bath.
1. Coloque la parte interior al lado del baño y alinéela con el baño.

2. Size is as per the photo.
2. el tamaño es según la foto

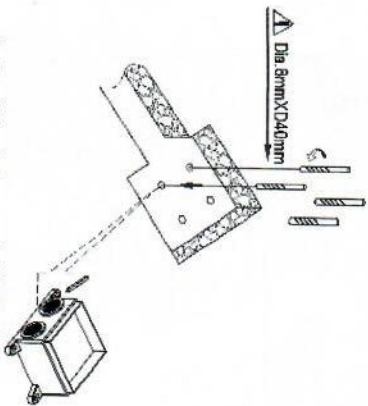

3. Mark the holes and drill dia.8mm holes with D40mm.
3. Resalice los orificios y taladre orificios de 8 mm con D40 mm.

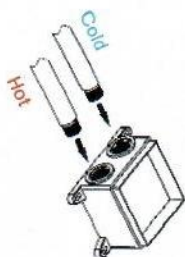

4. Connect the pipes correctly.
4. conecta las tuberías correctamente

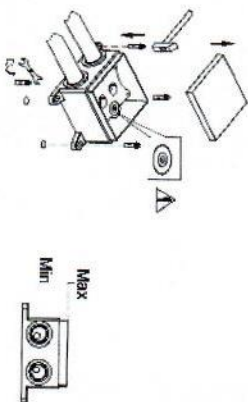

5. Remove the dust cover and adjust it to horizontal and then screw it.
5. retire la cubierta antipolvo y ajústela a la horizontal y luego atornillela

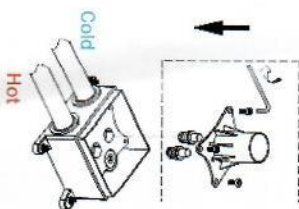

6. Install the sealing part and test the water pressure.
6. Instalar la parte de sellado y probar la presión del agua.

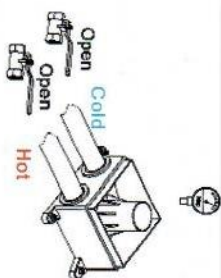

7. Test more than 10 min with 0.8MPA+ water pressure to make sure no leaking.
7. pruebe más de 10min con 0.8MPA + presión de agua para asegurarse de que no haya fugas

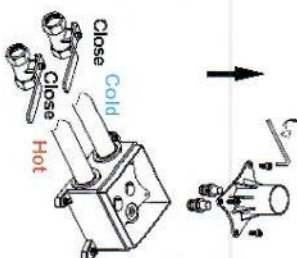

8. Off the water and remove the testing pipe.
8. Apague el agua y retire el tubo de prueba.

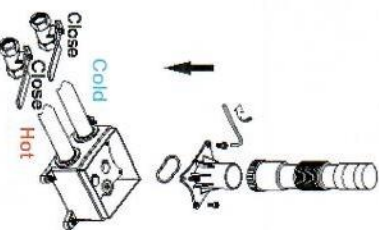

9. Install cleaning parts.
9. instalar piezas de limpieza

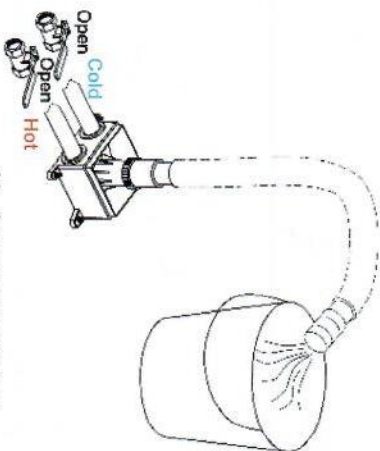

10. Clean the input pipe.
10. limpiar el tubo de entrada

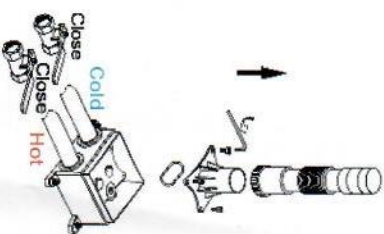

11. Off the water supply and remove the cleaning parts.
11. Apague el agua y retire la parte de limpieza.

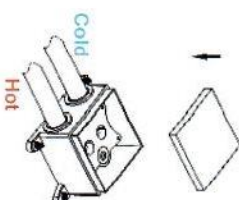

12. Put the cover.
12. pon la tapa