

IMEX
Bath equipments

IMEX BATH EQUIPMENTS



IMEX PRODUCTS S.L é uma empresa situada em Picassent, Valência e dedicamo-nos ao fabrico e comercialização de rampas de duche e torneiras, começamos a nossa caminha em 2001, fornecendo materiais de casa de banho a empresas fabricantes do setor.

Com o tempo, desenvolvemos vários catálogos e fomos melhorando os nossos produtos até atingir desenhos e preços muitos competitivos no mercado.

Todos os produtos utilizados são de gama média-alta, usando as melhores matérias primas do mercado, como o latão S304 e S316 que nos fizeram ter representação nacional e internacional. Na Imex tentamos sempre estar à frente no desenho.

Os nossos valores como empresa são: a fabulosa relação qualidade-desenho-preço. E os nossos compromissos com os clientes são os seguintes:

- Conseguir o máximo de qualidade
- Ter presente que o cliente é a nossa principal preocupação e a sua satisfação o nosso principal objetivo
- Estar rodeados de grandes profissionais

Para isso tentamos adotar uma posição de melhora e inovação

O resultado de tudo vê-se refletido no catálogo que poderá ver a continuação.

BÉLGICA

SÉRIE





BÉLGICA

SÉRIE

CROMO

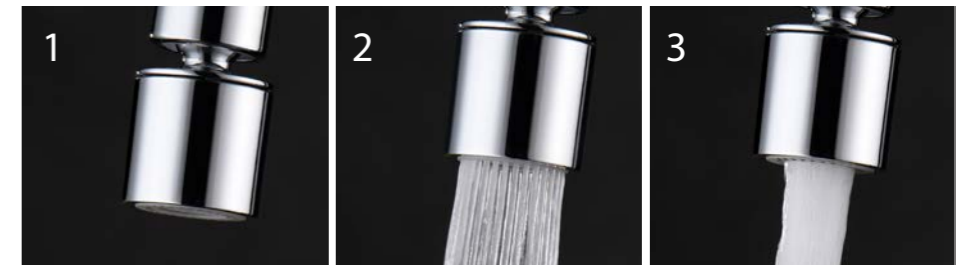

Opcional, ver página 147 do catálogo

Ref.: GCZ044

Torneira monocomando.
Corpo da torneira em latão.
Acabamento cromado.
Cartucho cerâmico Ø35mm.
Flexíveis de Ø3/8"
Perlator de junta esférica não incluído.

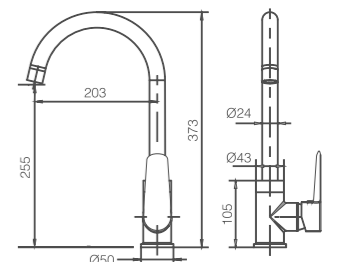

BÉLGICA

SÉRIE

PRETO MATE

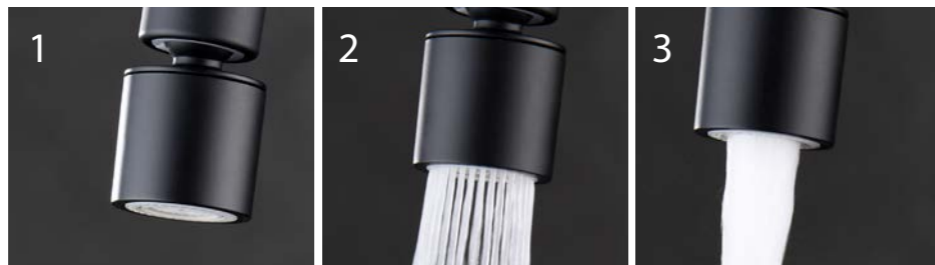

Opcional, ver página 147 do catálogo

Ref.: GCZ044/NG

Torneira monocomando.
Corpo da torneira em latão.
Acabamento preto mate.
Cartucho cerâmico Ø35mm.
Flexíveis de Ø3/8"
Perlator de junta esférica não incluído.

UNE
Normalización
Española

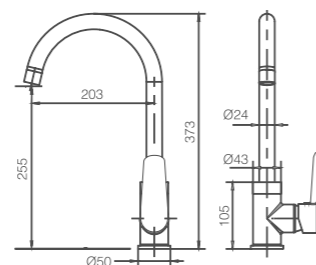

Grifería con
certificación



BERNA

SÉRIE





BERNA

SÉRIE

CROMO

Ref.: GCE026

Torneira monocomando.
Bica extraível.
Perlator de duas posições
Corpo da torneira em latão.
Acabamento cromado.
Cartucho cerâmico Ø35mm.
Flexíveis de Ø3/8"

Cold open.

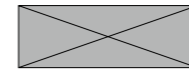

Grifería con certificación

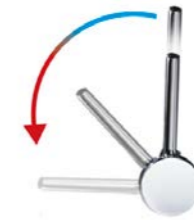

SISTEMA DE POUANÇA DE ENERGIA

UNE
Normalización Española



2 JET

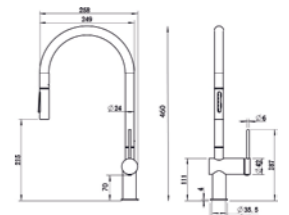



BERNA

SÉRIE

PRETO MATE

Ref.: **GCE026/NG**

Torneira monocomando.
Bica extraível.
Perlator de duas posições
Corpo da torneira em latão.
Acabamento preto mate.
Cartucho cerâmico Ø35mm.
Flexíveis de Ø3/8"

Cold open.



SISTEMA DE POUPANÇA DE ENERGIA

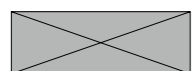
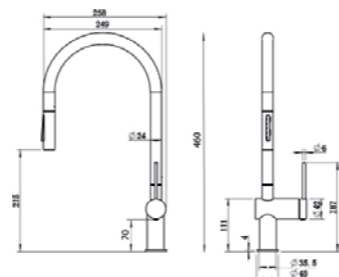

Grifería con certificación





BERNA

SÉRIE

OURO ROSA MATE

PVD COLLECTION

Ref.: GCE026/ORC

Torneira monocomando.
Bica extraível.
Perlator de duas posições
Corpo da torneira em latão.
Acabamento ouro rosa mate.
Cartucho cerâmico Ø35mm.
Flexíveis de Ø3/8"

Cold open.

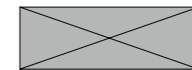

Griferia con certificación

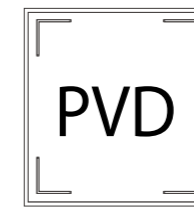

SISTEMA
DE POUPANÇA
DE ENERGIA

UNE
Normalización
Española

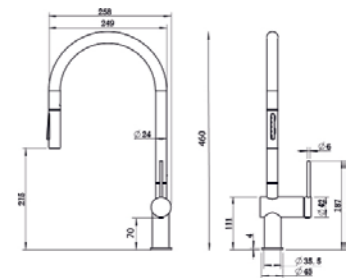

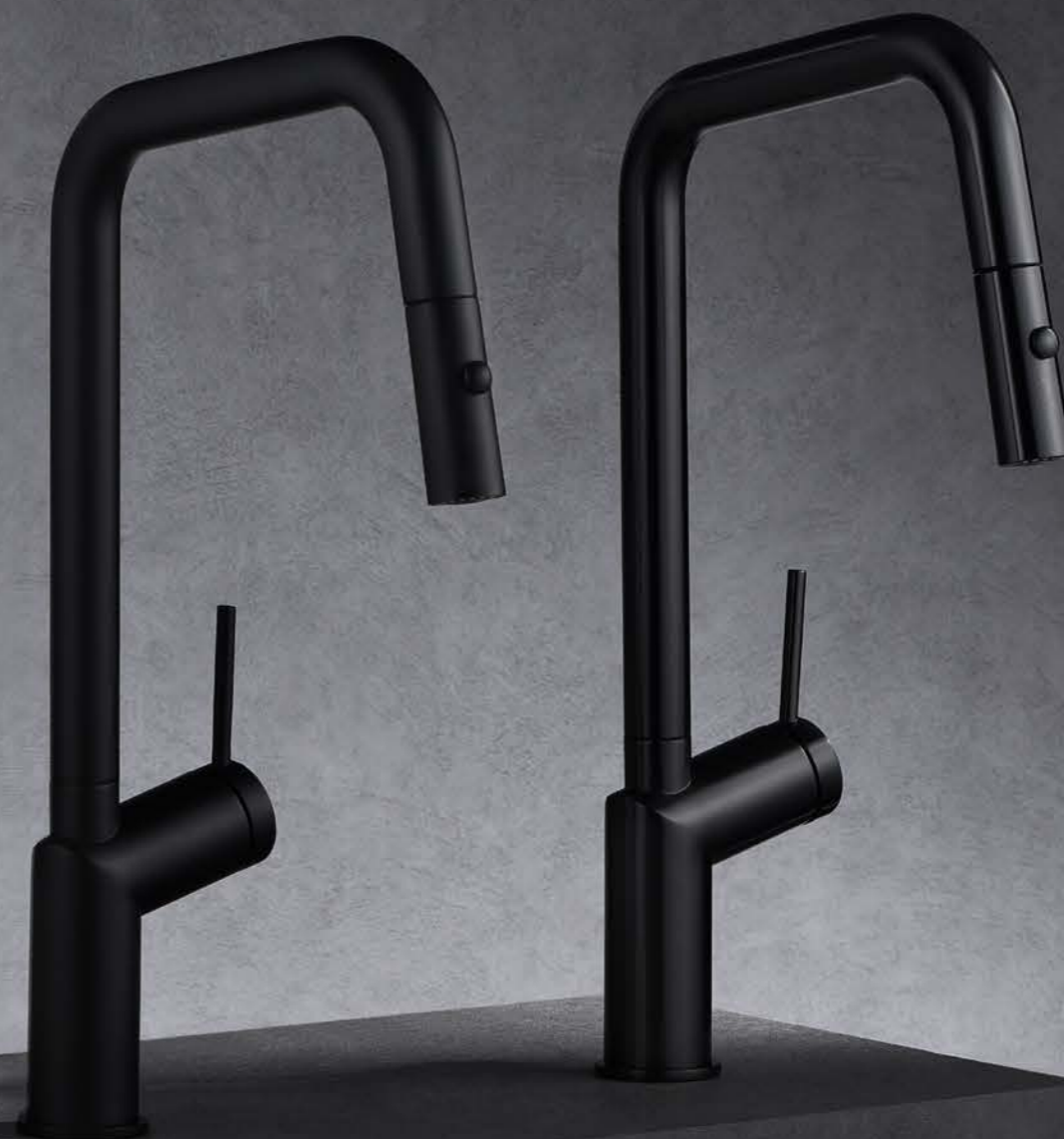

BONN

SÉRIE



BONN

SÉRIE

CROMO

Ref.: GCE024

Torneira monocomando.
Bica extraível.
Perlator de duas posições
Corpo da torneira em latão.
Acabamento cromado.
Cartucho cerâmico Ø35mm.
Flexíveis de Ø3/8"

UNE
Normalización
Española

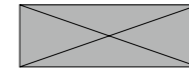
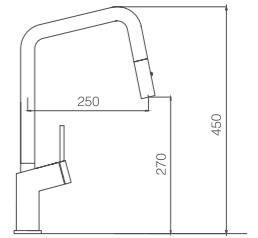
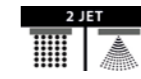

Grifería con
certificación



BONN

BLACK GUN METAL

SÉRIE



BONN

SÉRIE

BLACK GUN METAL

PVD COLLECTION

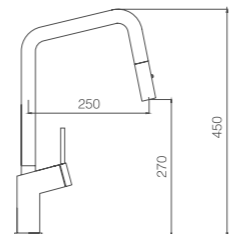

Ref.: GCE024/BGM

Torneira monocomando.
Bica extraível.
Perlator de duas posições
Corpo da torneira em latão.
Acabamento black gun metal.
Cartucho cerâmico Ø35mm.
Flexíveis de Ø3/8"

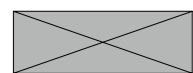

Grifería con certificación





BONN

SÉRIE

PRETO MATE

Ref.: **GCE024/NG**

Torneira monocomando.
 Bica extraível.
 Perlator de duas posições
 Corpo da torneira em latão.
 Acabamento preto mate.
 Cartucho cerâmico Ø35mm.
 Flexíveis de Ø3/8"

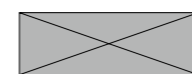

Grifería con certificación





BONN

SÉRIE

OURO MATE

PVD COLLECTION

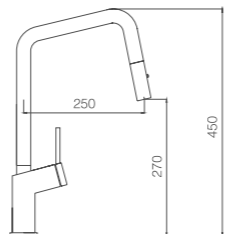

Ref.: GCE024/OC

Torneira monocomando.
Bica extraível.
Perlator de duas posições
Corpo da torneira em latão.
Acabamento ouro mate.
Cartucho cerâmico Ø35mm.
Flexíveis de Ø3/8"

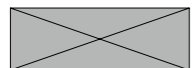

Grifería con certificación



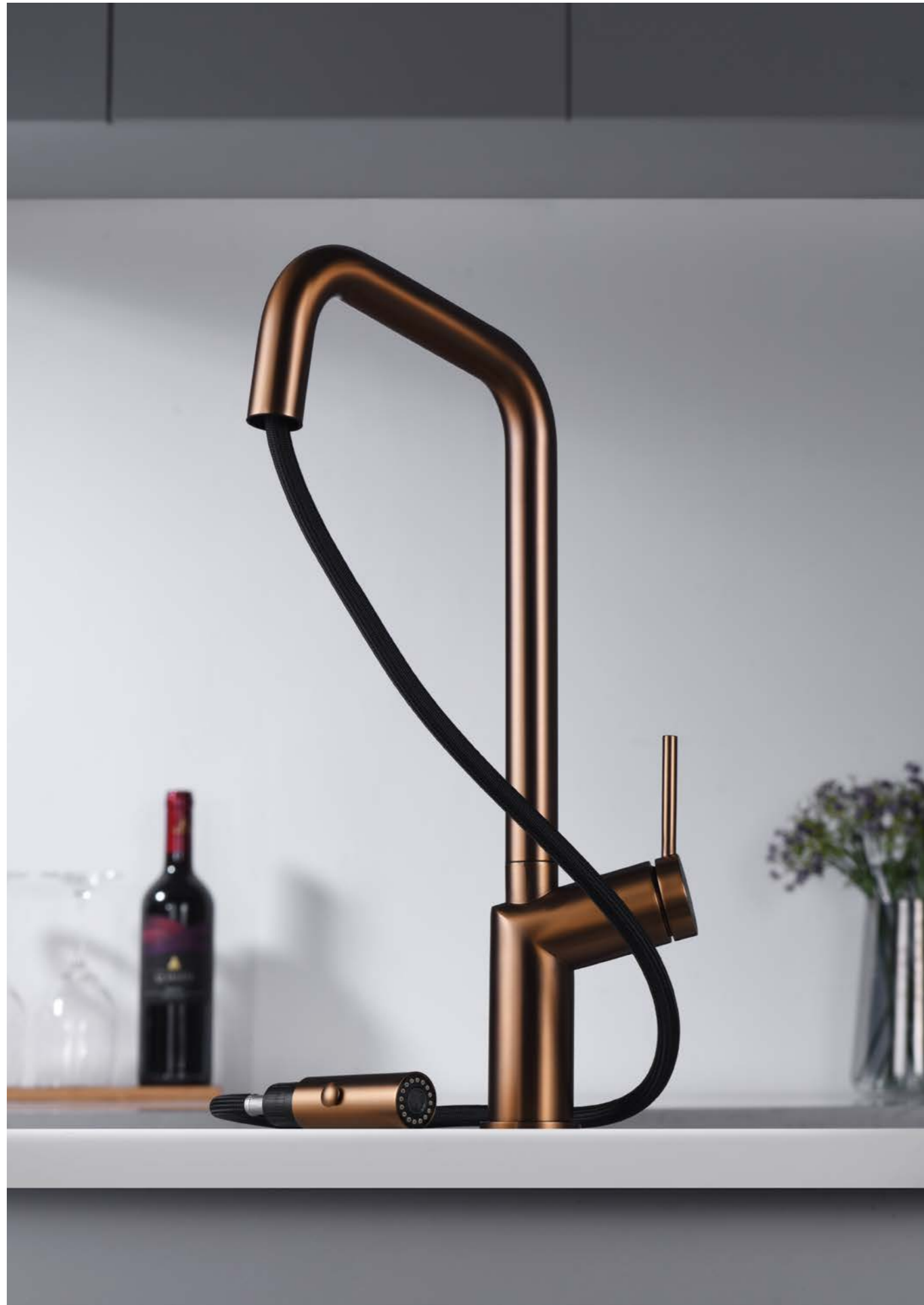

BONN

SÉRIE

OURO ROSA MATE

Ref.: GCE024/ORC

Torneira monocomando.
 Bica extraível.
 Perlator de duas posições
 Corpo da torneira em latão.
 Acabamento ouro rosa mate.
 Cartucho cerâmico Ø35mm.
 Flexíveis de Ø3/8"

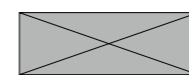
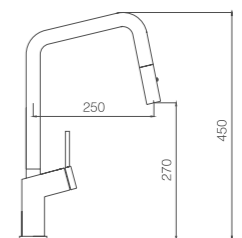
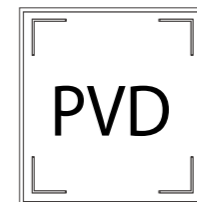

Grifería con certificación



Osmose

CAPRI

SÉRIE

CROMO



Ref.: **GOS002**

Torneira monocomando de duas vias (Osmose)
Seletor de via giratório.
Corpo da torneira em latão.
Acabamento cromado.
Cartucho cerâmico Ø35mm.
Flexíveis de Ø3/8"

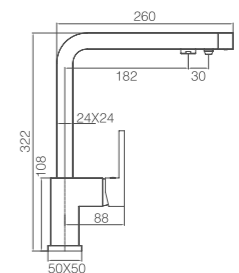

Grifería con certificación





CAPRI

SÉRIE

PRETO MATE

Osmose



Ref.: **GOS002/NG**

Torneira monocomando de duas vias (Osmose)
 Seletor de via giratório.
 Corpo da torneira em latão.
 Acabamento preto mate.
 Cartucho cerâmico Ø35mm.
 Flexíveis de Ø3/8"

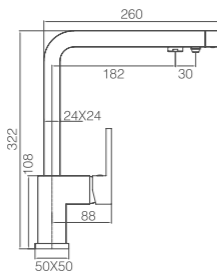

CONSTANZA

SÉRIE

CROMO



Ref: GCE005

Torneira monocomando.
Bica extraível.
Perlator de duas posições
Corpo da torneira em latão.
Acabamento cromado.
Cartucho cerâmico Ø35mm.
Flexíveis de Ø3/8"

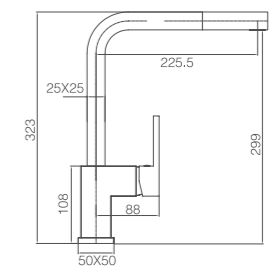

UNE
Normalización
Española



Grifería con
certificación





COX

SÉRIE

CROMO



Ref.: GCC001

Torneira monocomando.
Giro 360°.
Corpo da torneira em latão.
Acabamento cromado.
Cartucho cerâmico Ø35mm.
Flexíveis de Ø3/8"

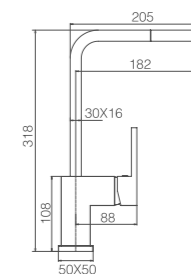

DEVA

SÉRIE

AÇO S316



Ref.: GCE023/AC

GCE023/AC
Torneira monocomando.
Bica flexível.
Fabricada em aço inoxidável S.316.
Resistência máxima anticorrosão
Cartucho cerâmico Ø25mm.
Flexíveis de Ø3/8"

UNE
Normalización
Española

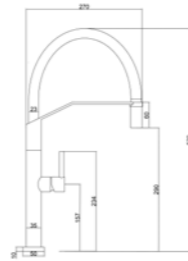



ITACA

SÉRIE

CROMO



Ref.: GCE018

Torneira monocomando.
Bica escamoteável.
Em duas partes independentes.
Corpo da torneira em latão.
Acabamento cromado.
Cartucho cerâmico Ø25mm.
Flexíveis de Ø3/8"

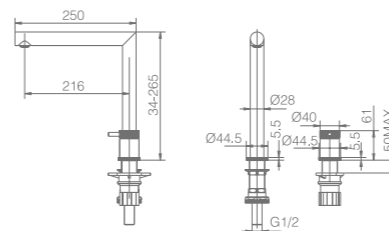

Installation



ITACA

SÉRIE

PRETO MATE

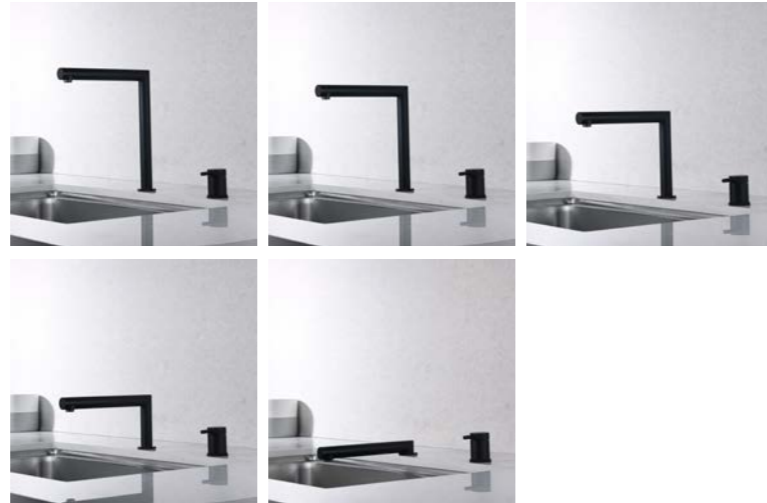

Ref.: GCE018/NG

Torneira monocomando.
Bica escamoteável.
Em duas partes independentes.
Corpo da torneira em latão.
Acabamento preto mate.
Cartucho cerâmico Ø25mm.
Flexíveis de Ø3/8"

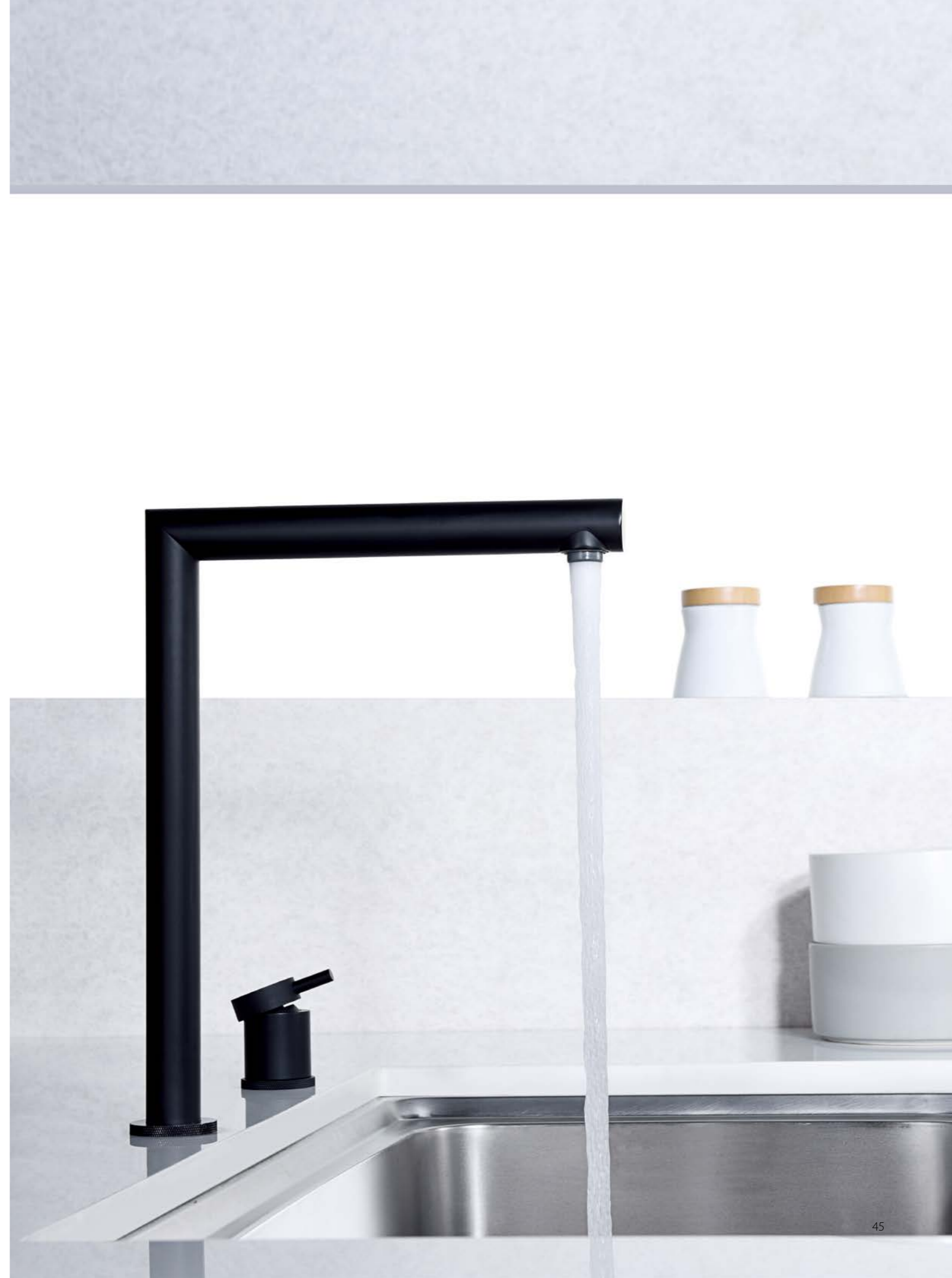
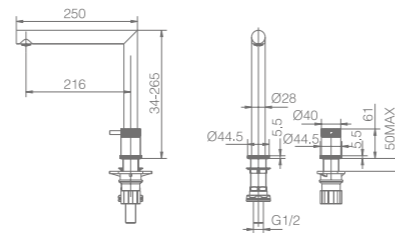

KENIA

SÉRIE



KENIA

SÉRIE

CROMO



Ref.: GCE020

Torneira monocomando.
Corpo da torneira em latão.
Acabamento cromado.
Cartucho cerâmico Ø35mm.
Flexíveis de Ø3/8"

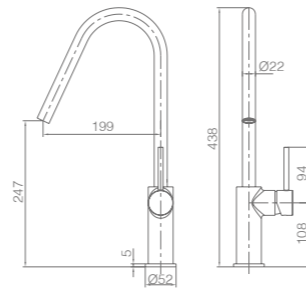

Grifería con certificación





KENIA

SÉRIE

PRETO MATE



Ref.: GCE020/NG

Torneira monocomando.
Corpo da torneira em latão.
Acabamento preto mate.
Cartucho cerâmico Ø35mm.
Flexíveis de Ø3/8"



Grifería con certificación

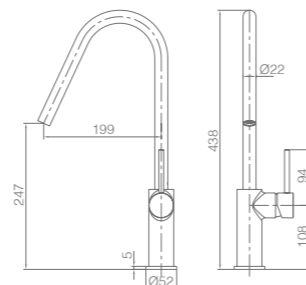

KENIA

SÉRIE

LATÃO ESCOVADO



Ref.: GCE020/NQ

Torneira monocomando.
Corpo da torneira em latão.
Acabamento níquel cepillado.
Cartucho cerâmico Ø35mm.
Flexíveis de Ø3/8"



Grifería con certificación

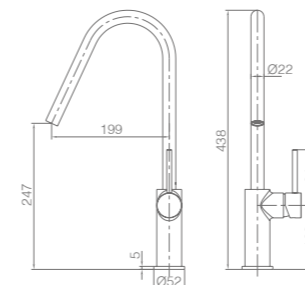



KENIA

SÉRIE

OURO MATE

PVD COLLECTION

Ref.: GCE020/OC

Torneira monocomando.
Corpo da torneira em latão.
Acabamento ouro mate.
Cartucho cerâmico Ø35mm.
Flexíveis de Ø3/8"

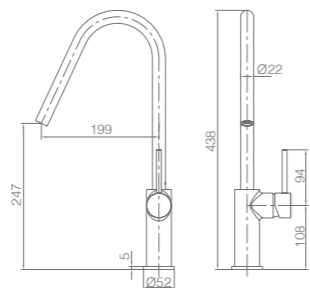
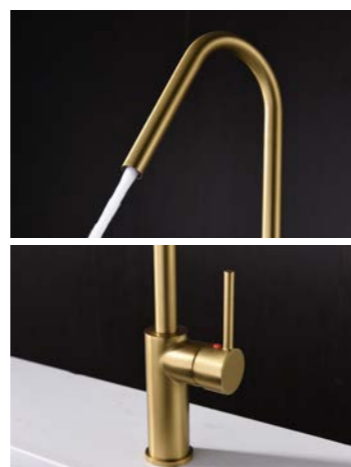

KENIA

SÉRIE

OURO ROSA MATE

PVD COLLECTION



Ref.: GCE020/ORC

Torneira monocomando.
Corpo da torneira em latão.
Acabamento ouro rosa mate.
Cartucho cerâmico Ø35mm.
Flexíveis de Ø3/8"

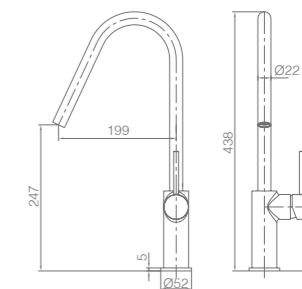

LANZAROTE

SÉRIE

CROMO

Ref: GCE015

Torneira monocomando.
Bica flexível.
Perlator de duas posições
Corpo da torneira em latão.
Acabamento cromado.
Cartucho cerâmico Ø25mm.
Flexíveis de Ø3/8"

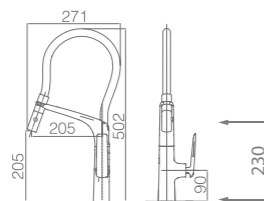

LAOS

SÉRIE

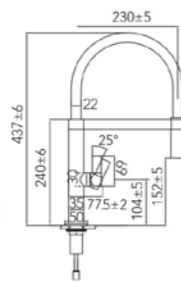

Altura mínima 37 cm

CROMO

PRETO MATE

BRANCO MATE



Ref.: GCE011

Torneira monocomando.
Bica flexível.
Corpo da torneira em latão.
Acabamento cromado.
Cartucho cerâmico Ø25mm.
Flexíveis de Ø3/8"

Ref.: GCE012

Torneira monocomando.
Bica flexível.
Corpo da torneira em latão.
Acabamento preto mate.
Cartucho cerâmico Ø25mm.
Flexíveis de Ø3/8"

Ref.: GCE014

Torneira monocomando.
Bica flexível.
Corpo da torneira em latão.
Acabamento branco mate.
Cartucho cerâmico Ø25mm.
Flexíveis de Ø3/8"



LOIRA

SÉRIE





LOIRA

SÉRIE

CROMO



Opcional, ver página 147 do catálogo

Ref.: GCR004

Torneira monocomando.
Corpo da torneira em latão.
Acabamento cromado.
Cartucho cerâmico Ø35mm.
Flexíveis de Ø3/8"
Perlator de junta esférica não incluído.

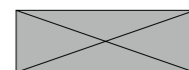
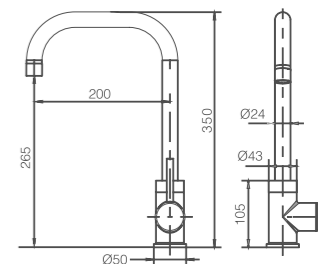

LOIRA

SÉRIE

BLACK GUN METAL



Opcional, ver página 147 do catálogo



PVD COLLECTION

Ref.: GCR004/BGM

Torneira monocomando.
Corpo da torneira em latão.
Acabamento black gun metal.
Cartucho cerâmico Ø35mm.
Flexíveis de Ø3/8"
Perlator de junta esférica não incluído.

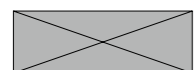
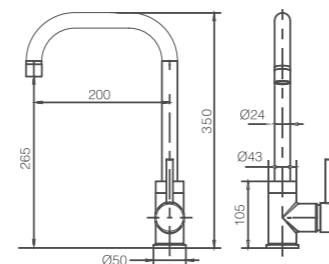

Grifería con certificación





LOIRA

SÉRIE

PRETO MATE

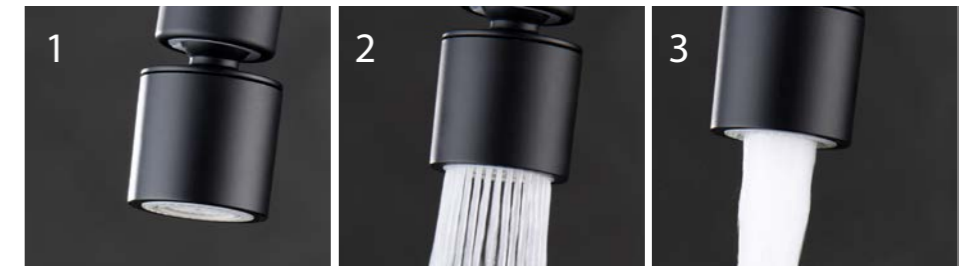

Opcional, ver página 147 do catálogo

Ref.: **GCR004/NG**

Torneira monocomando.
Corpo da torneira em latão.
Acabamento preto mate.
Cartucho cerâmico Ø35mm.
Flexíveis de Ø3/8"
Perlator de junta esférica não incluído.

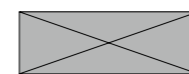
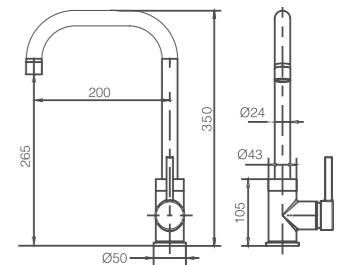

Grifería con certificación



LOIRA

SÉRIE

OURO MATE

PVD COLLECTION



Opcional, ver página 147 do catálogo



Ref.: GCR004/OC

Torneira monocomando.
Corpo da torneira em latão.
Acabamento ouro mate.
Cartucho cerâmico Ø35mm.
Flexíveis de Ø3/8"
Perlator de junta esférica não incluído.

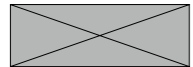
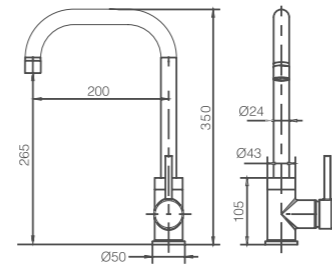

Grifería con certificación





LOIRA

SÉRIE

OURO ROSA MATE

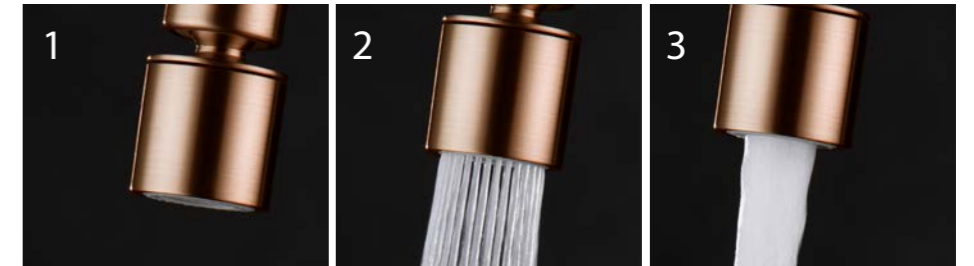

Opcional, ver página 147 do catálogo



PVD COLLECTION

Ref.: GCR004/ORC

Torneira monocomando.
Corpo da torneira em latão.
Acabamento - ouro rosa mate.
Cartucho cerâmico Ø35mm.
Flexíveis de Ø3/8"
Perlator de junta esférica não incluído.

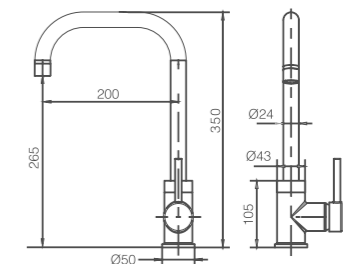
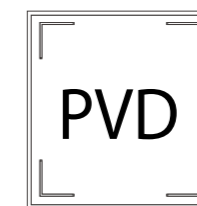
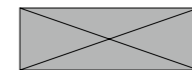



LYON

SÉRIE

CROMO



Opcional, ver página 147 do catálogo

Ref.: GCR002

Torneira monocomando.
Corpo da torneira em latão.
Acabamento cromado.
Cartucho cerâmico Ø35mm.
Flexíveis de Ø3/8"
Perlator de junta esférica não incluído.



Grifería con certificación



Installation

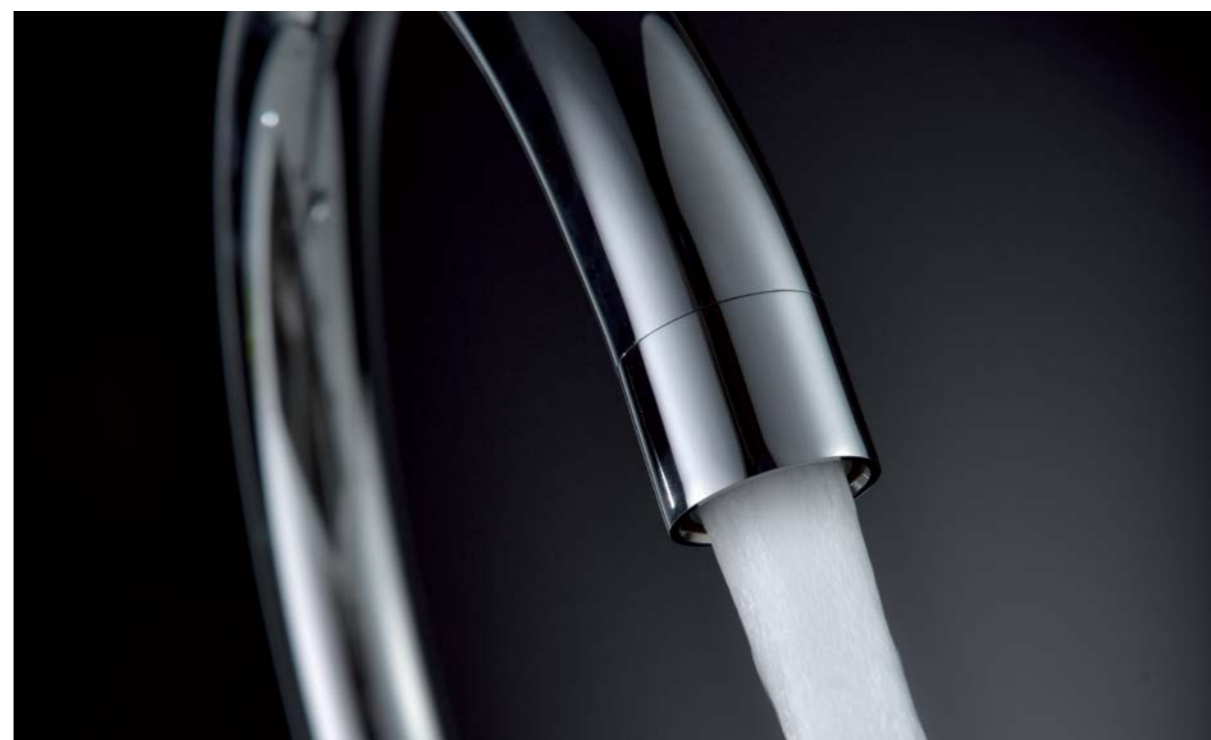
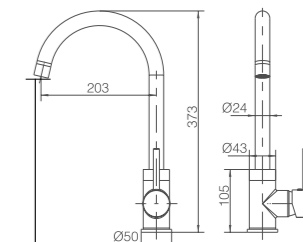

LYON

SÉRIE

PRETO MATE



Opcional, ver página 147 do catálogo

Ref: GCR002/NG

Torneira monocomando.
Corpo da torneira em latão.
Acabamento preto mate.
Cartucho cerâmico Ø35mm.
Flexíveis de Ø3/8"
Perlator de junta esférica não incluído.



Grifería con certificación



< Installation

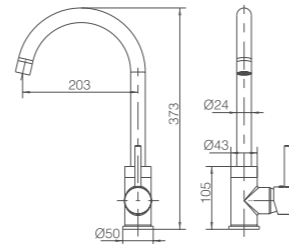

MALTA

SÉRIE



MALTA

SÉRIE





MALTA

SÉRIE

CROMO



Ref.: GCE006

Torneira monocomando.
Bica extraível.
Corpo da torneira em latão.
Acabamento cromado.
Cartucho cerâmico Ø35mm.
Flexíveis de Ø3/8"



Installation >

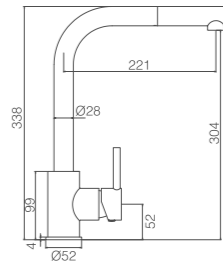

MALTA

SÉRIE

AÇO S316



Ref.: GCE006/AC



Torneira monocomando.
Bica extraível.
Corpo da torneira em aço s.316.
Resistência máxima anticorrosão
Cartucho cerâmico Ø35mm.
Flexíveis de Ø3/8"

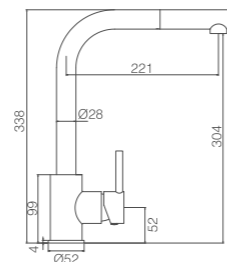

Grifería con certificación





MALTA

SÉRIE

BLACK GUN METAL

PVD COLLECTION

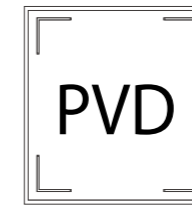

Installation >



Ref.: GCE006/BGM

Torneira monocomando.
Bica extraível.
Corpo da torneira em latão.
Acabamento black gun metal.
Cartucho cerâmico Ø35mm.
Flexíveis de Ø3/8"

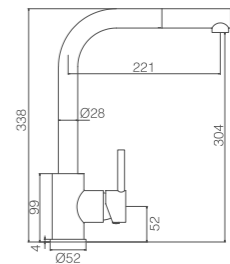

Grifería con certificación



MALTA

SÉRIE

PRETO MATE

Ref.: GCE006/NG

Torneira monocomando.
Bica extraível.
Corpo da torneira em latão.
Acabamento preto mate.
Cartucho cerâmico Ø35mm.
Flexíveis de Ø3/8"

UNE
Normalización
Española

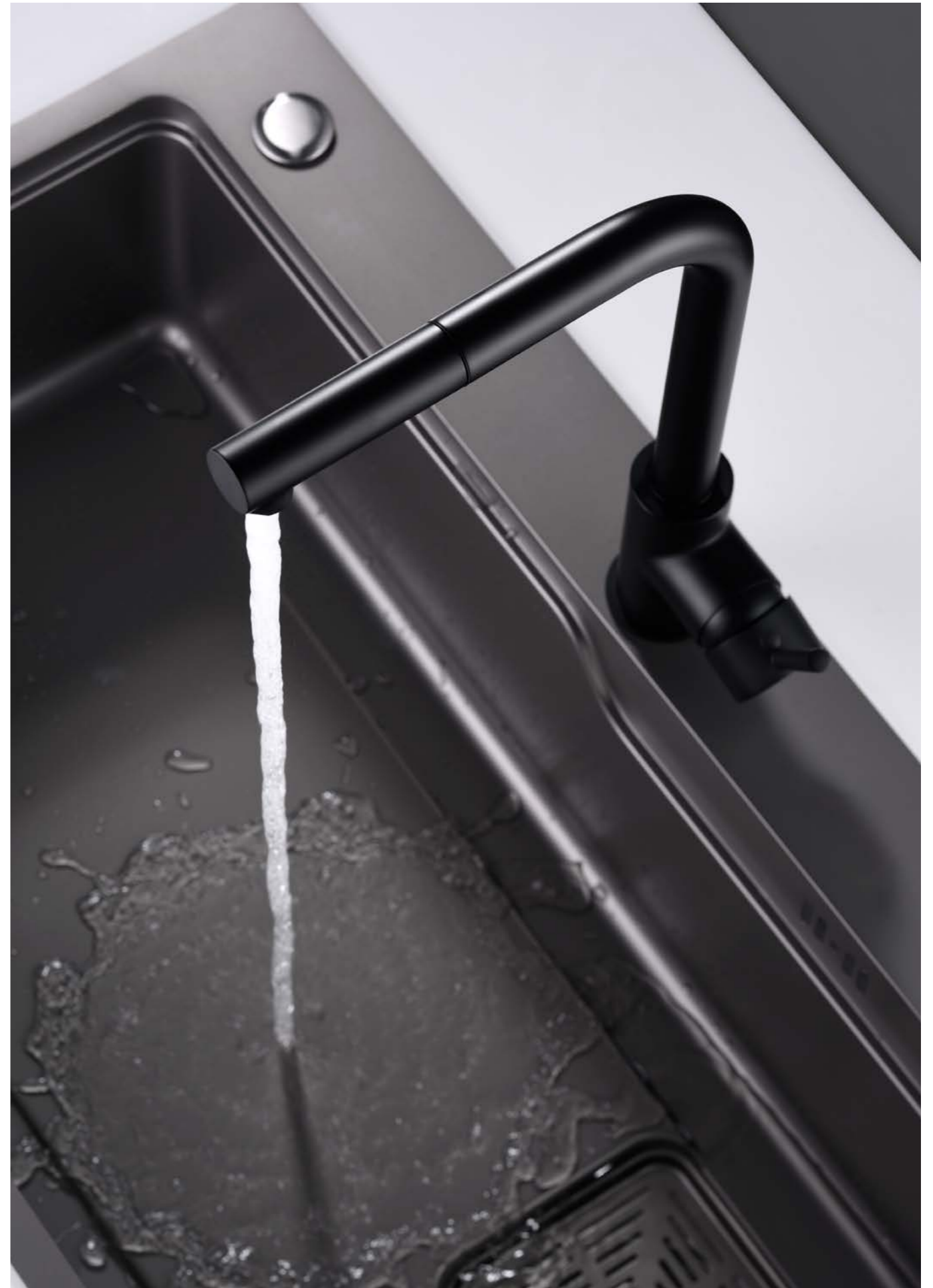
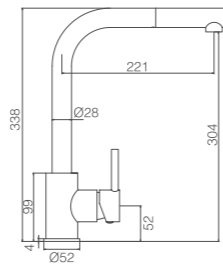



MALTA

SÉRIE

BRANCO MATE

Ref.: GCE006/BL

Torneira monocomando.
Bica extraível.
Corpo da torneira em latão.
Acabamento branco mate.
Cartucho cerâmico Ø35mm.
Flexíveis de Ø3/8"



Grifería con certificación



Installation >

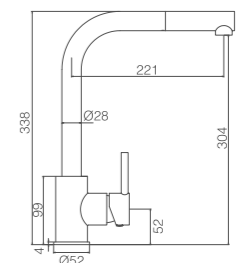

MALTA

SÉRIE

OURO MATE

PVD

PVD COLLECTION

Ref.: GCE006/OC

Torneira monocomando.
Bica extraível.
Corpo da torneira em latão.
Acabamento ouro mate.
Cartucho cerâmico Ø35mm.
Flexíveis de Ø3/8"

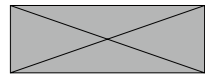
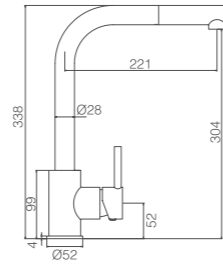



MALTA

SÉRIE

OURO ROSA MATE

PVD COLLECTION

Ref.: GCE006/ORC

Torneira monocomando.
Bica extraível.
Corpo da torneira em latão.
Acabamento ouro rosa mate.
Cartucho cerâmico Ø35mm.
Flexíveis de Ø3/8"

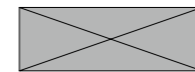

Grifería con certificación

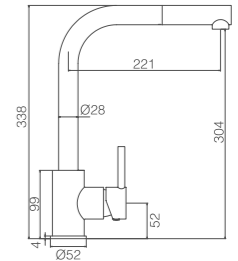



MANACOR

SÉRIE

CROMO



Opcional, ver página 147 do catálogo

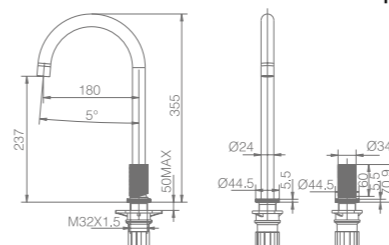

Ref.: GCM001

Torneira monocomando.
Em duas partes independentes.
Corpo da torneira em latão.
Acabamento cromado.
Cartucho cerâmico Ø25mm.
Flexíveis de Ø3/8"
Perlator de junta esférica não incluído.



MANACOR

SÉRIE

PRETO MATE



Opcional, ver página 147 do catálogo



MANACOR

SÉRIE

BRANCO MATE



Ref.: GCM001/NG

Torneira monocomando.
Em duas partes independentes.
Corpo da torneira em latão.
Acabamento preto mate.
Cartucho cerâmico Ø25mm.
Flexíveis de Ø3/8"
Perlator de junta esférica não incluído.

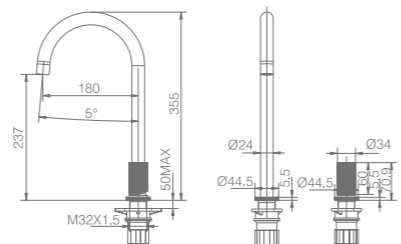

Ref.: GCM001/BL

Torneira monocomando.
Em duas partes independentes.
Corpo da torneira em latão.
Acabamento branco mate.
Cartucho cerâmico Ø25mm.
Flexíveis de Ø3/8"

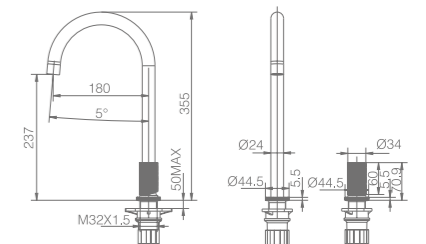

MARSELLA

SÉRIE

CROMO

Osmose



Ref.: GOS004

Torneira monocomando de duas vias (Osmose)
Seletor de vias independente.
Corpo da torneira em latão.
Acabamento cromado.
Cartucho cerâmico Ø35mm.
Flexíveis de Ø3/8"

UNE
Normalización
Española

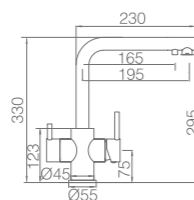

MARSELLA

SÉRIE

PRETO MATE

Osmose



Ref.: GOS004/NG

Torneira monocomando de duas vias (Osmose)

Seletor de vias independente.

Corpo da torneira em latão.

Acabamento preto mate.

Cartucho cerâmico Ø35mm.

Flexíveis de Ø3/8"

UNE
Normalización
Española

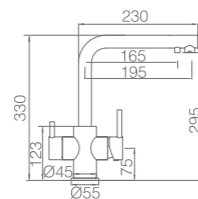



MENORCA

SÉRIE

CROMO



Ref.: GCE019

Torneira monocomando.
Bica flexível.
Perlator de duas posições
Corpo da torneira em latão.
Acabamento cromado.
Cartucho cerâmico Ø25mm.
Flexíveis de Ø3/8"

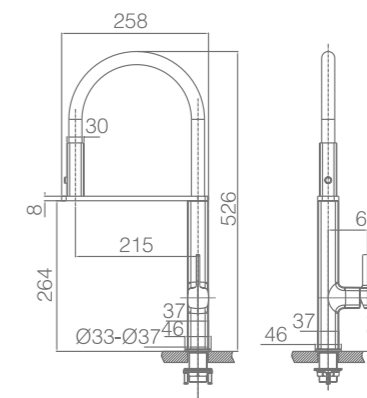

MENORCA

SÉRIE

PRETO MATE



Ref.: GCE019/NG

Torneira monocomando.
Bica flexível.
Perlator de duas posições.
Corpo da torneira em latão.
Acabamento preto mate.
Cartucho cerâmico Ø25mm.
Flexíveis de Ø3/8"

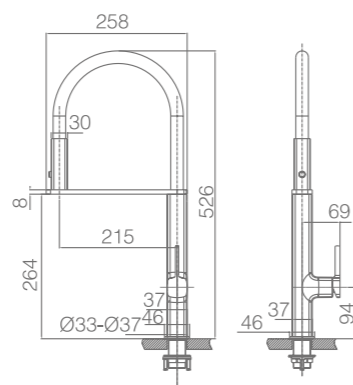

MONTECARLO

SÉRIE

CROMO



Ref.: GOS001

Torneira monocomando de duas vias (Osmose)
Seletor de via giratorio.
Corpo da torneira em latão.
Acabamento cromado.
Cartucho cerâmico Ø40mm.
Flexíveis de Ø3/8"

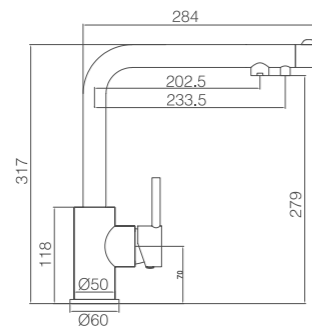

Installation

Osmose



NIZA

SÉRIE





NIZA

SÉRIE

CROMO

Ref.: GCE027

Torneira monocomando.
 Bica extraível.
 Perlator de duas posições
 Corpo da torneira em latão.
 Acabamento cromado.
 Cartucho cerâmico Ø30mm.
 Flexíveis de Ø3/8"

UNE
 Normalización
 Española

2 JET

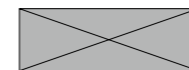
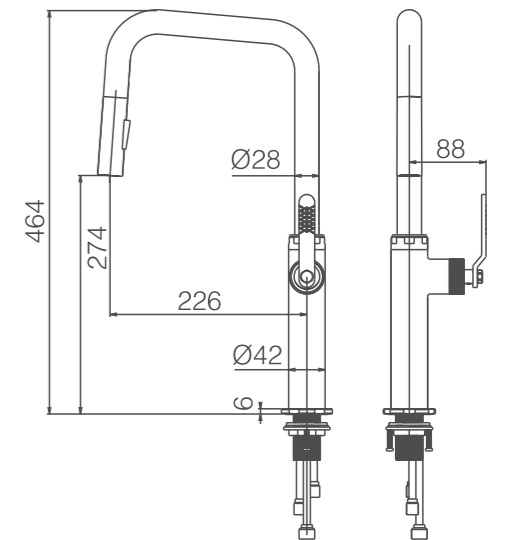

Grifería con
 certificación



NIZA

SÉRIE

BLACK GUN METAL

PVD COLLECTION

Ref.: GCE027/BGM

Torneira monocomando.
Bica extraível.
Perlator de duas posições.
Corpo da torneira em latão.
Acabamento black gun metal.
Cartucho cerâmico Ø30mm.
Flexíveis de Ø3/8"

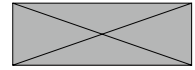

Grifería con
certificación



UNE
Normalización
Española

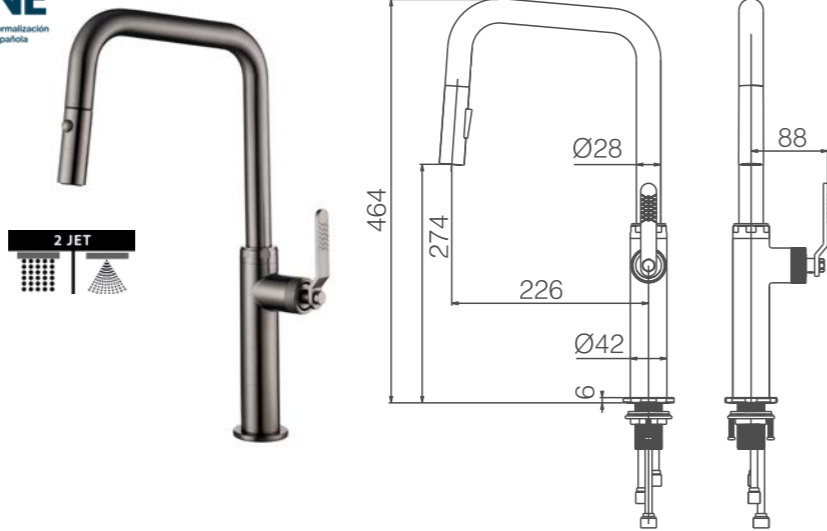



NIZA

SÉRIE

PRETO MATE

Ref.: **GCE027/NG**

Torneira monocomando.
Bica extraível.
Perlator de duas posições.
Corpo da torneira em latão.
Acabamento preto mate.
Cartucho cerâmico Ø30mm.
Flexíveis de Ø3/8"

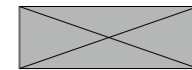
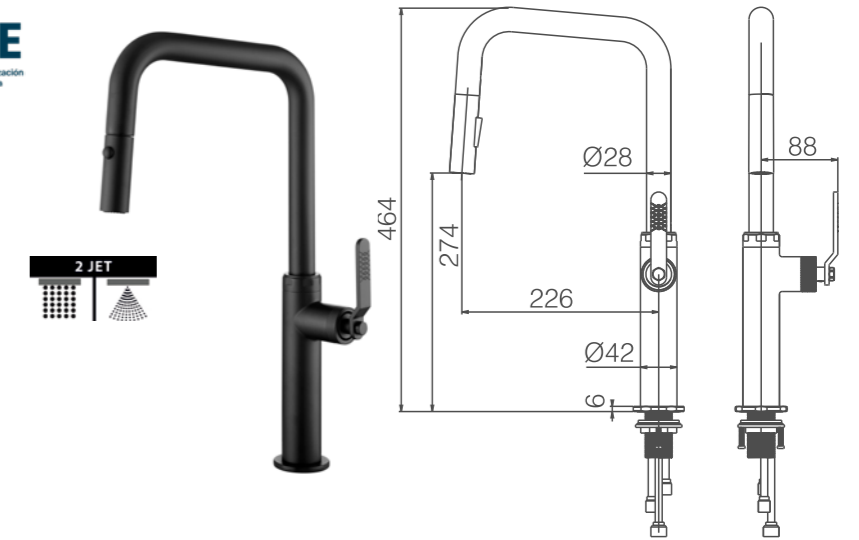

Grifería con certificación ACS

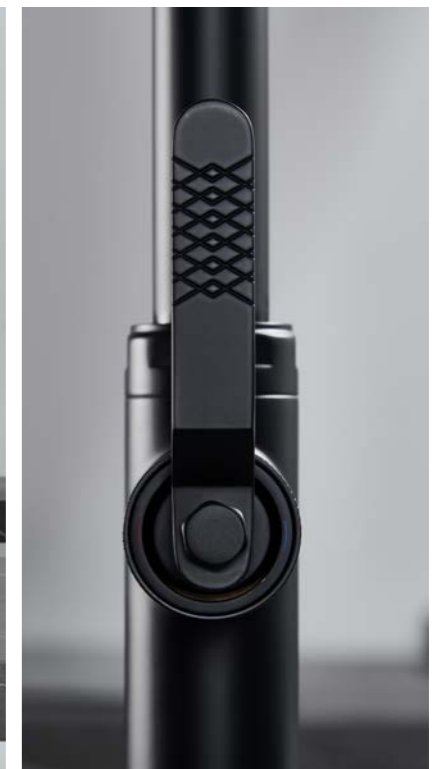



NIZA

SÉRIE

OURO MATE



PVD COLLECTION

Ref.: **GCE027/OC**

- Torneira monocomando.
- Bica extraível.
- Perlator de duas posições
- Corpo da torneira em latão.
- Acabamento ouro mate.
- Cartucho cerâmico Ø30mm.
- Flexíveis de Ø3/8"

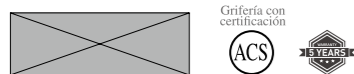
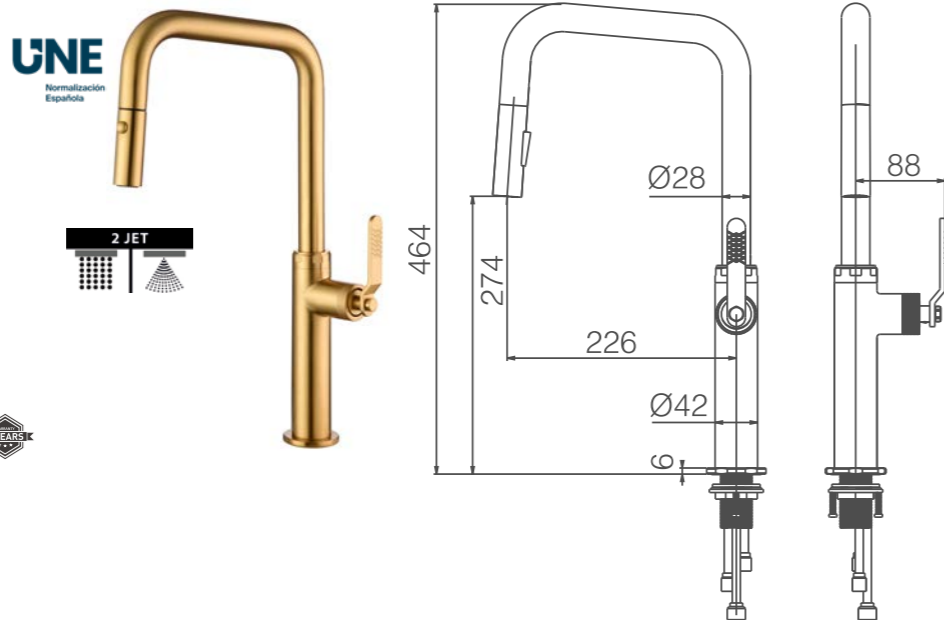



NIZA

SÉRIE

OURO ROSA MATE

PVD COLLECTION



Ref.: **GCE027/ORC**

Torneira monocomando.
Bica extraível.
Perlator de duas posições
Corpo da torneira em latão.
Acabamento ouro rosa mate.
Cartucho cerâmico Ø30mm.
Flexíveis de Ø3/8"

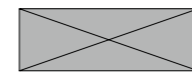
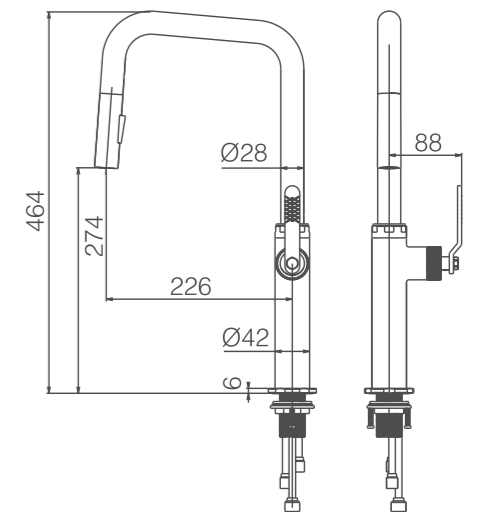
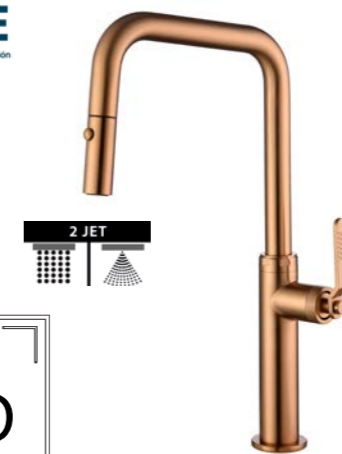



SAMOA

SÉRIE

CROMO

Ref.: GCE017

Torneira monocomando.
Bica extraível.
Perlator de duas posições
Corpo da torneira em latão.
Acabamento cromado.
Cartucho cerâmico Ø25mm.
Flexíveis de Ø3/8"

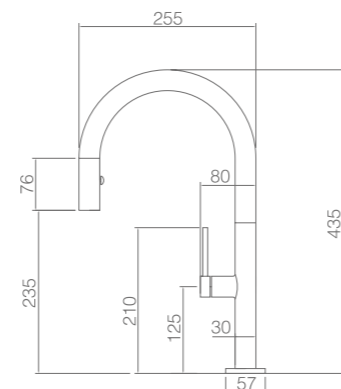

SAMOA

SÉRIE

BRANCO MATE

Ref.: GCE017/BL

Torneira monocomando.
Bica extraível.
Perlator de duas posições
Corpo da torneira em latão.
Acabamento branco mate.
Cartucho cerâmico Ø25mm.
Flexíveis de Ø3/8"

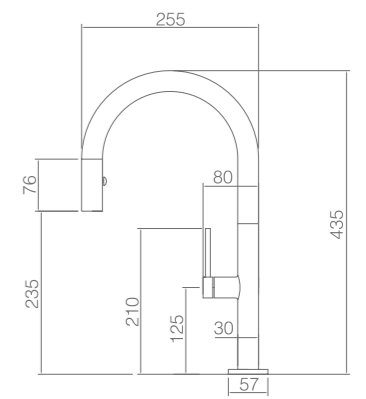



SAMOA

SÉRIE

PRETO MATE

Ref.: GCE017/NG

Torneira monocomando.
Bica extraível.
Perlator de duas posições
Corpo da torneira em latão.
Acabamento preto mate.
Cartucho cerâmico Ø25mm.
Flexíveis de Ø3/8"

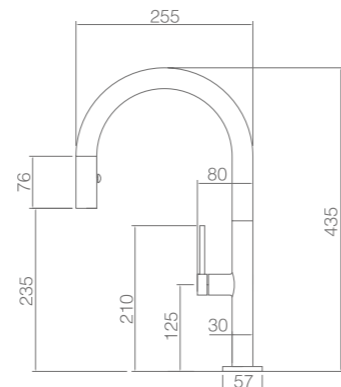

SAMOA

SÉRIE

PRETO MATE

OURO ROSA MATE

Ref.: GCE017/NOR

Torneira monocomando.
Bica extraível.
Perlator de duas posições
Corpo da torneira em latão.
Acabamento preto mate con detalles oro rosa brillo.
Cartucho cerâmico Ø25mm.
Flexíveis de Ø3/8"

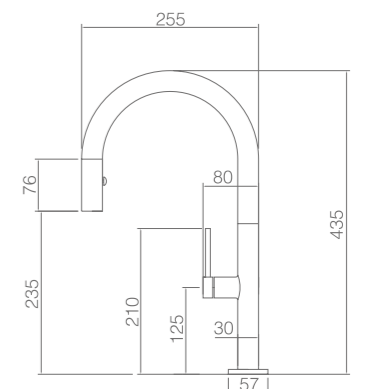

SENA

SÉRIE



SENA

SÉRIE

CROMO



Ref.: GCE022

Torneira monocomando.
Bica flexível.
Corpo da torneira em latão.
Acabamento cromado.
Cartucho cerâmico Ø30mm.
Flexíveis de Ø3/8"

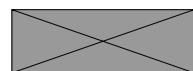
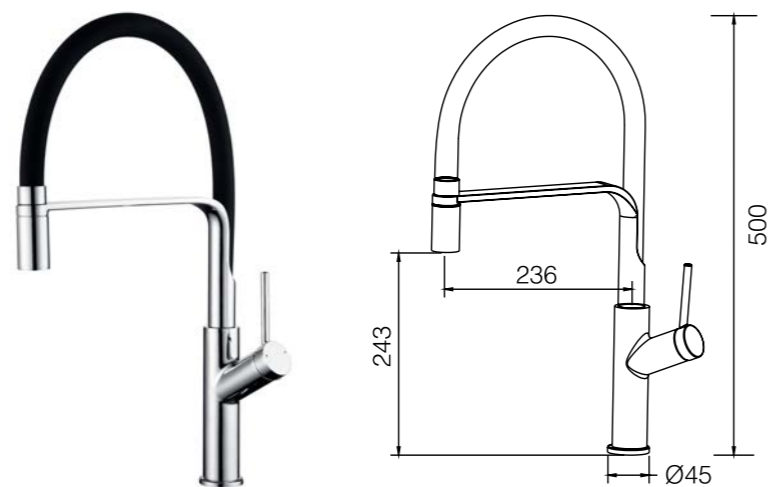

Griferia con certificación





SENA

SÉRIE

BLACK GUN METAL

PVD COLLECTION

Ref.: GCE022/BGM

Torneira monocomando.
Bica flexível.
Corpo da torneira em latão.
Acabamento black gun metal.
Cartucho cerâmico Ø30mm.
Flexíveis de Ø3/8"



Grifería con
certificación

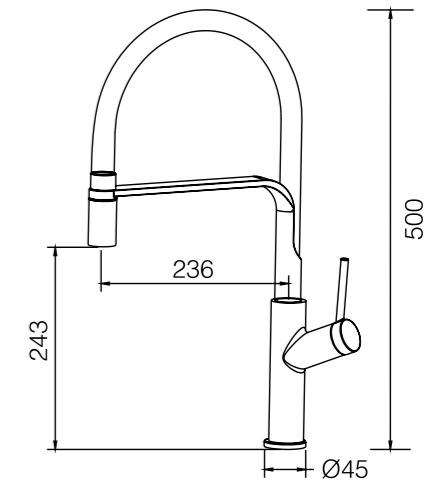
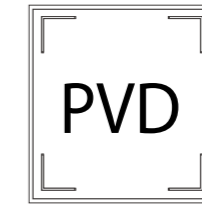

SENA

SÉRIE

PRETO MATE

Ref.: GCE022/NG

Torneira monocomando.
Bica flexível.
Corpo da torneira em latão.
Acabamento preto mate.
Cartucho cerâmico Ø30mm.
Flexíveis de Ø3/8"

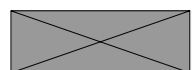
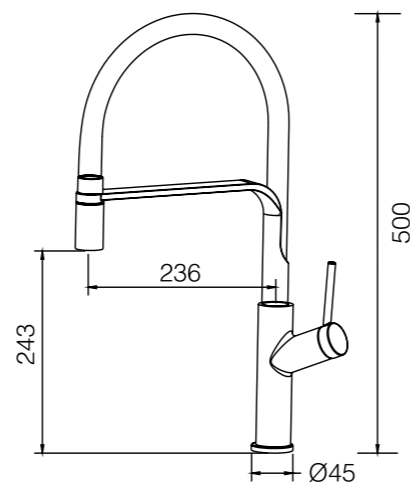

Grifería con certificación





SENA

SÉRIE

OURO MATE



PVD COLLECTION

Ref.: GCE022/OC

Torneira monocomando.
Bica flexível.
Corpo da torneira em latão.
Acabamento ouro mate.
Cartucho cerâmico Ø30mm.
Flexíveis de Ø3/8"

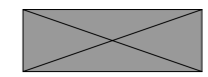
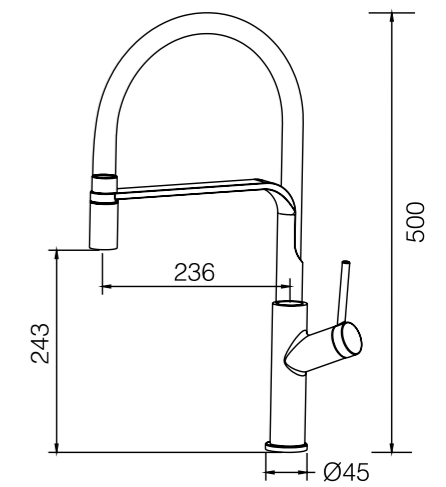

Grifería con certificación



SENA

SÉRIE

OURO ROSA MATE

PVD COLLECTION

Ref.: GCE022/ORC

Torneira monocomando.
Bica flexível.
Corpo da torneira em latão.
Acabamento ouro rosa mate.
Cartucho cerâmico Ø30mm.
Flexíveis de Ø3/8"

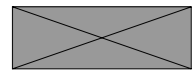

Grifería con certificación

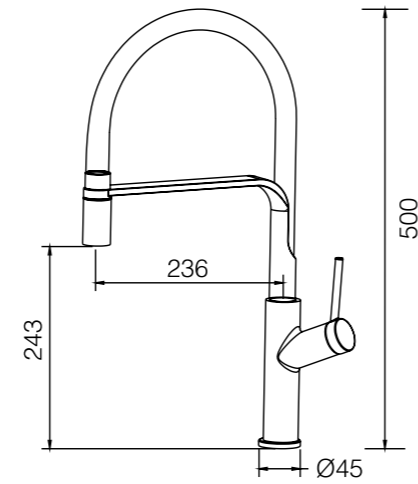

TOKYO

SÉRIE

CROMO

Ref.: GCE016

Torneira monocomando.
Bica flexível.
Perlator de duas posições
Corpo da torneira em latão.
Acabamento cromado.
Cartucho cerâmico Ø35mm.
Flexíveis de Ø3/8"

Cold open.



SISTEMA DE POUANÇA DE ENERGIA

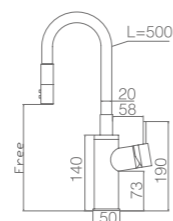

Altura máxima recomendada 47 cm





TOULOUSE

SÉRIE

CROMO



Ref.: GCE008

Torneira monocomando.
 Bica flexível.
 Perlator de duas posições
 Corpo da torneira em latão.
 Acabamento cromado.
 Cartucho cerâmico Ø35mm.
 Flexíveis de Ø3/8"



Hose 50 cm

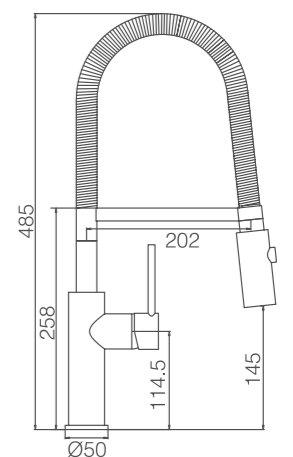

TURIN

SÉRIE





TURIN

SÉRIE

CROMO



Instructions d'installation et d'entretien.

Ref.: GCE021

Torneira monocomando.
Bica extraível.
Tecnologia On/off (start/stop) com sensor de movimento e visor digital com temperatura da água.
Perlator de duas posições
Corpo da torneira em latão.
Acabamento cromado.
Cartucho cerâmico Ø35mm.
Flexíveis de Ø3/8"

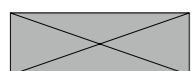
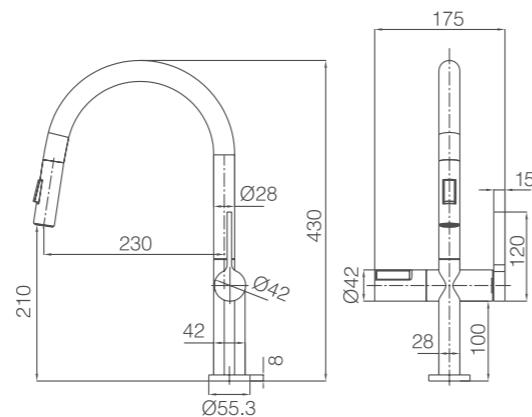

Grifería con certificación





TURIN

SÉRIE

PRETO MATE



Instructions d'installation
et d'entretien.

Ref.: GCE021/NG

Torneira monocomando.
Bica extraível.
Tecnologia On/off (start/stop) com sensor de movimento e visor digital com temperatura da água.
Perlator de duas posições
Corpo da torneira em latão.
Acabamento preto mate.
Cartucho cerâmico Ø35mm.
Flexíveis de Ø3/8"

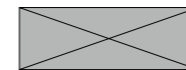
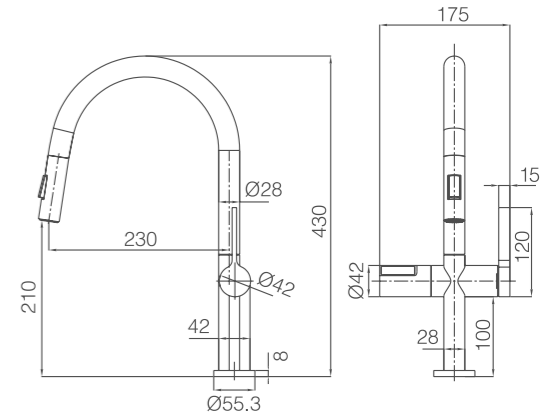

Grifería con
certificación



VENECIA

SÉRIE

CROMO



Ref.: GCE100

Torneira monocomando.
Perlator giratorio.
Corpo da torneira em latão.
Acabamento cromado.
Cartucho cerâmico Ø35mm.
Flexíveis de Ø3/8"

UNE
Normalización
Española

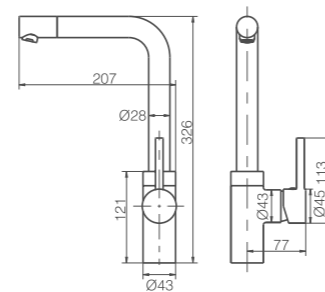

Grifería con
certificación



COMPLEMENTOS



Ref.: RR0031
Perlator de rotula M22x1, com 2 funções
Material: ABS
Acabado: CROMO

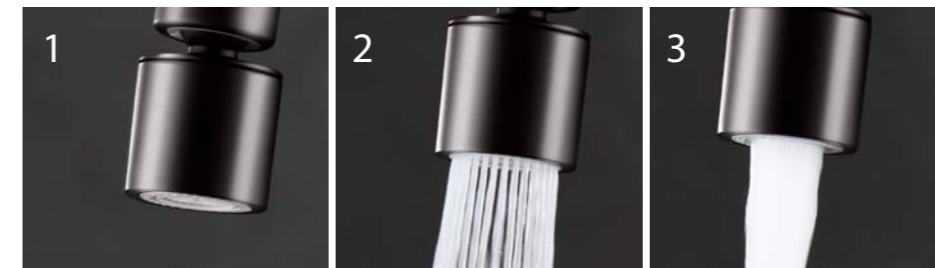

Ref.: RR0031/BGM
Perlator de rotula M22x1, com 2 funções
Material: ABS
Acabado: BLACK GUN METAL



Ref.: RR0031/NG
Perlator de rotula M22x1, com 2 funções
Material: ABS
Acabado: PRETO MATE



Ref.: RR0031/OC
Perlator de rotula M22x1, com 2 funções
Material: ABS
Acabado: OURO MATE



Ref.: RR0031/ORC
Perlator de rotula M22x1, com 2 funções
Material: ABS
Acabado: OURO ROSA MATE



INSTALAÇÃO TUTORIAL

Instalação Tutorial

Torneira monocomando.



Ref. GCZ044	Bélgica	pag.	007
Ref. GCC001	Cox	pag.	039
Ref. GCE020	Kenia	pag.	048
Ref. GCR004	Loira	pag.	061
Ref. GCR002	Lyon	pag.	071
Ref. GCE100	Venecia	pag.	144

Torneira monocomando. Bica extraível.



Ref. GCE026	Berna	pag.	013
Ref. GCE024	Bonn	pag.	023
Ref. GCE005	Constanza	pag.	037
Ref. GCE006	Malta	pag.	079
Ref. GCE027	Niza	pag.	109
Ref. GCE017	Samoa	pag.	118

Torneira monocomando de duas vias (Osmose)



Ref. GOS002	Capri	pag.	033
Ref. GOS001	Montecarlo	pag.	104
Ref. GOS004	Marsella	pag.	096

Torneira monocomando. Bica escamoteable.



Ref. GCE018	Itaca	pag.	043
-------------	-------	------	-----

Torneira monocomando. Tecnologia On/off (start/stop)



Ref. GCE021	Turin	pag.	140
-------------	-------	------	-----

EXPOSITORES



Ref.: 1EXP0023 (8 Torneiras)



Ref.: 1EXP0024 (14 Torneiras)



Ref.: 1EXP0028
Iluminados com luz led
(10 Torneiras)

Ref.: 1EXP0033
Iluminados com luz led
(10 Torneiras)



Ref.: 1EXP0034
Iluminados com luz led
(10 Torneiras)



CONDIÇÕES GERAIS DE VENDA

ENTREGAS

Verifique a mercadoria no momento da sua receção. Não serão aceites reclamações relativas a mercadorias não verificadas no momento da entrega. A empresa de transportes indicará tal situação na guia de transporte.

DEVOLUÇÕES

Em caso de devolução, descreva com clareza o motivo da mesma. A IMEX PRODUCTS, S.L. ou o seu representante apenas aceitarão aquelas devoluções que preencham os seguintes requisitos:

- O material deverá apresentar algum tipo de defeito de fabrico.
- A embalagem deverá estar em perfeitas condições, caso assim não seja será aplicada uma penalização de 10% do valor dessa mercadoria como despesas de receção, revisão e manuseamento.

FORMA DE PAGAMENTO

Transferência bancária ou cheque a 30 dias

Qualquer atraso que se produza terá como consequência a interrupção do serviço bem como o débito das custas bancárias e outras despesas relacionadas.

TRIBUNAIS

Em caso de litígio, ambas as partes submeter-se-ão aos tribunais de Picassent (Espanha) caso tenha sido o fabricante a faturar ou aos tribunais de Vila do Conde caso tenha sido o distribuidor a faturar.

TRANSPORTE

Serão cobrados 7€ de portes nos pedidos que não tenham valor superior a 200€.

ACTUALIZAÇÃO E MANUTENÇÃO DAS COLEÇÕES

ALTERAÇÃO DO MODELO

Em ocasiões, alguns dos produtos fornecidos pela IMEX PRODUCTS, S.L., podem apresentar alterações em algumas das suas peças em relação às imagens do catálogo atual.

IMEX PRODUCTS S.L., reserva-se o direito de realizar ditas alterações nos seus modelos sendo sempre em busca de melhorias tanto na imagem como na funcionalidade do produto, além das condições de venda.

CONSELHOS DE LIMPEZA E MANUTENÇÃO

Na IMEX PRODUCTS S.L. aconselhamos para realizar a limpeza dos nossos produtos, em cores preto mate ou branco mate, que se utilizem produtos não corrosivos e com um PH neutro, evitando assim, danificar os produtos.

Seguindo as recomendações do fabricante, aconselhamos utilizar pano de microfibras no processo de limpeza e finalizar com a secagem dos produtos para assim alargar a vida dos mesmos.

Vídeo de demonstração





IMEX PRODUCTS, S.L.

Pol.Ind. Picassent, calle 6 parcela 11
46220 Picassent (Valencia) - Spain

Tlfs. de contacto:

T.: +34 96 065 12 74

T.: +34 96 156 63 87

T.: +34 63 040 29 47

www.imexproducts.es
export@imexproducts.es