



IMEX
BATH EQUIPMENTS

IMEX BATH EQUIPMENTS



IMEX PRODUCTS,S.L.

Somos una empresa ubicada en Torrent, (València), dedicada a la fabricación y comercialización de barras de ducha y griferías. Empezamos nuestra andadura en el año 2001, suministrando materiales de baño y ducha a empresas fabricantes en el sector.

Con el paso de los años y la experiencia acumulada, desarrollamos varios catálogos y evolucionamos nuestros productos hasta llegar a tener representación comercial en todo el territorio nacional e internacional.

Todos los productos que utilizamos son de gama media/alta, usando siempre materiales como el latón o el acero S304 y S316.

No utilizamos ABS o plástico en nuestros productos*.

Algunas de nuestras principales señas de identidad son, la fabulosa relación calidad precio, de las mejores del mercado, y nuestra dedicación y compromiso con el servicio.



INDEX



GRIFERÍA MONOMANDO REDONDA

- Pag. 06 Roma series ●●
- Pag. 18 Dinamarca series ●●○
- Pag. 30 Milos series ●●
- Pag. 46 Escocia series ●
- Pag. 50 Luxor series ●●○
- Pag. 62 Elba series ●
- Pag. 70 Milan series ●
- Pag. 74 Paris series ●
- Pag. 78 Sintra series ●
- Pag. 82 Nassau series ●
- Pag. 88 Madrid series ●
- Pag. 92 Olimpo series ●●●
- Pag. 104 Moscú series ●
- Pag. 110 Córcega series ●●
- Pag. 114 Teide series ●



GRIFERÍA TERMOSTÁTICA

- Pag. 210 Kent series ●
- Pag. 212 Creta series ●
- Pag. 216 Amsterdam series ●
- Pag. 218 Praga series ●
- Pag. 220 Londres series ●●○
- Pag. 226 Bled series ●
- Pag. 228 Vigo series ●●○
- Pag. 232 Sidney series ●



GRIFERÍA DE COCINA

- Pag. 378 Torino series ●
- Pag. 380 Samoa series ●●○●
- Pag. 384 Menorca series ●●
- Pag. 388 Itaca series ●●
- Pag. 392 Manacor series ●●○
- Pag. 396 Olimpo series ●●●
- Pag. 402 Lanzarote series ●
- Pag. 404 Toulouse series ●
- Pag. 406 Laos series ●●○
- Pag. 408 Malta series ●●○
- Pag. 414 Venecia series ●
- Pag. 416 Constanza series ●
- Pag. 418 Pireo series ●
- Pag. 420 Capri series ●
- Pag. 422 Montecarlo series ●
- Pag. 424 Marsella series ●
- Pag. 426 Lyon series ●
- Pag. 428 Mikonos series ●
- Pag. 440 Cox series ●
- Pag. 432 Verona series ●
- Pag. 433 Viena series ●
- Pag. 436 Tokyo series ●



GRIFERÍA MONOMANDO CUADRADA

- Pag. 122 Valencia series ●
- Pag. 128 Suecia series ●●●●
- Pag. 144 Art series ●●○
- Pag. 158 Bremen series ●
- Pag. 162 Liverpool series ●
- Pag. 166 Saona series ●
- Pag. 170 Bristol series ●
- Pag. 174 Nantes series ●
- Pag. 178 Fiyi series ●●○
- Pag. 196 Bali series ●
- Pag. 202 Europa series ●
- Pag. 204 Minsk series ●



DUCHAS EMPOTRADAS

- Pag. 236 Aruba series ●
 - Pag. 238 Bahamas series ●●○
 - Pag. 244 Borneo series ●
 - Pag. 246 Oslo series ●
 - Pag. 249 Mónaco series ●
 - Pag. 250 Dublín series ●●○
 - Pag. 253 Berlín series ●
 - Pag. 258 Volga series ●
 - Pag. 258 Gales series ●
 - Pag. 260 Sumatra series ●
 - Pag. 262 Rodas series ●●
 - Pag. 266 Málaga series ●
 - Pag. 268 Formentera series ●
 - Pag. 270 Java series ●
 - Pag. 272 Italia series ●
 - Pag. 275 Francia series ●
 - Pag. 276 Noruega series ●
 - Pag. 279 Finlandia series ●
 - Pag. 282 Ons series ●
 - Pag. 283 Cies series ●●○
 - Pag. 286 Milos series ●●○●
 - Pag. 288 Thalos series ●●
 - Pag. 296 Moscú series ●
 - Pag. 302 Madeira series ●●
 - Pag. 305 Portugal series ●●
 - Pag. 310 Hidra series ●●
 - Pag. 313 Feroe serie ●●
 - Pag. 318 Olimpo series ●●●
 - Pag. 321 Vesubio series ●●●
 - Pag. 330 Suecia series ●●●●
 - Pag. 333 Estocolmo serie ●●●●
 - Pag. 350 Malta series ●
 - Pag. 351 Suiza series ●●○
 - Pag. 354 Fiyi series ●●○
 - Pag. 358 Milos series ●●○●
 - Pag. 362 Etna series ●●○
 - Pag. 368 Olimpo serie ●●●
- Termostáticos
- Pag. 362 empotrados ●
 - Monomandos
 - Pag. 373 empotrados ●



ROCIADORES

Pag. 438 — Rociadores



BIDÉS EMPOTRADOS

Pag. 458 — Munich series ●●
 Pag. 462 — Suecia series ●●●●
 Pag. 470 — Maui series ●
 Pag. 472 — Irlanda series ●
 Pag. 474 — Ness series ●



ACCESORIOS DE DUCHA

Pag. 476 — Accesorios de ducha



MANGOS DE DUCHA

Pag. 488 — Austin series ●●●
 Pag. 489 — New York series ●●●
 Pag. 490 — Henk series ●●●
 Pag. 491 — Genova series ●●●
 Pag. 493 — Kansas series ●
 Pag. 493 — Nevada series ●
 Pag. 494 — Denver series ●



VÁLVULAS DE CLICK CLACK Y COMPLEMENTOS

Pag. 496 — Válvulas de click clack y complementos



COMPLEMENTOS, REPUESTOS Y EXPOSITORES

Pag. 504 — Complementos y repuestos
 Pag. 512 — Expositores

ACABADOS

- Cromado
- Negro mate
- Blanco mate
- Negro mate / Oro rosa
- Negro mate / Oro
- Acero inox.





GRIFERÍA MONOMANDO REDONDA

Modelos de líneas curvas y redondas que aportan al baño confort, elegancia y bienestar.



ROMA

SERIE



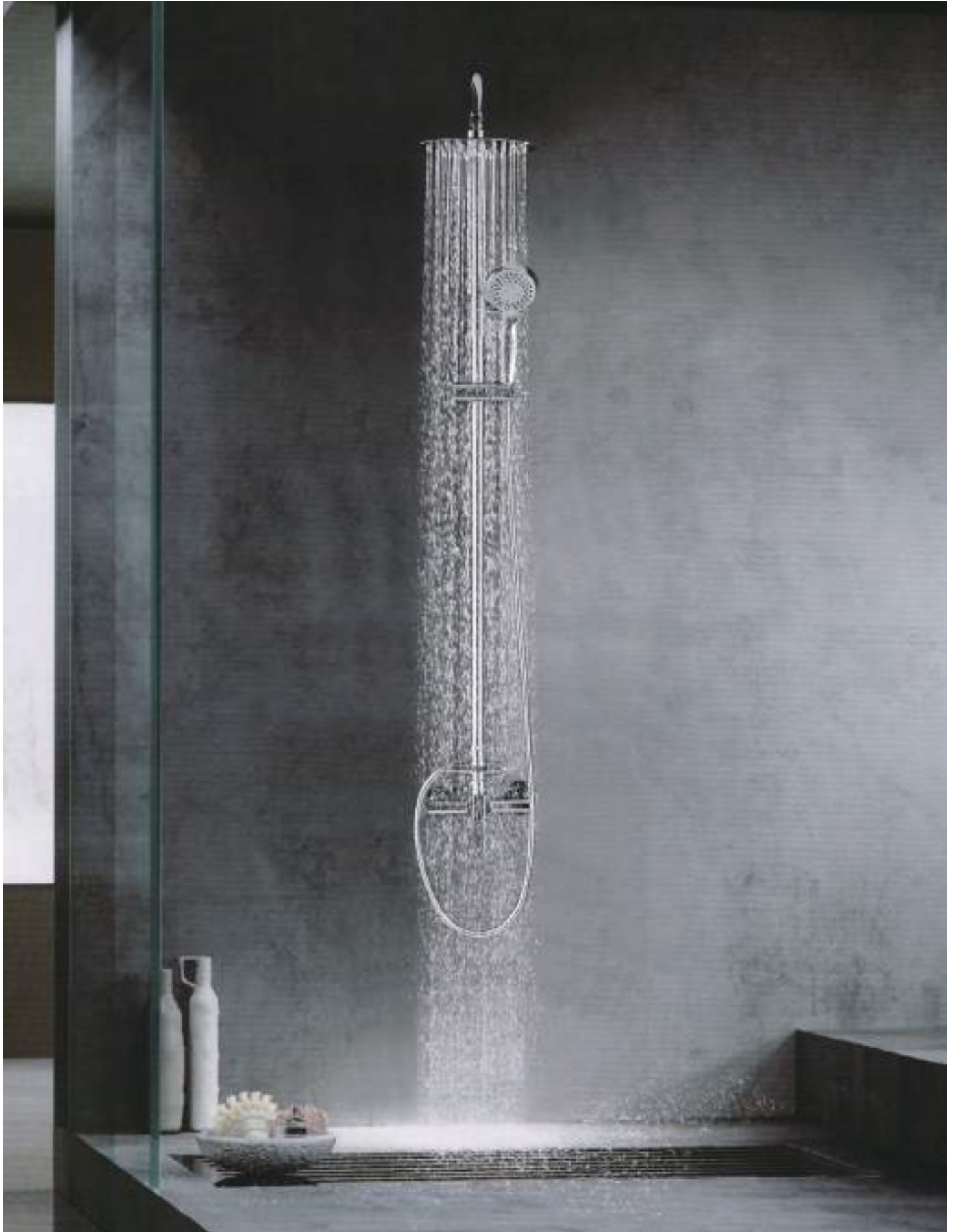

ROMA

SERIE



Un producto elegante y sobrio con una tecnología insuperable.



ROMA

SERIE

Modelo polivalente y adaptable a cualquier baño.
Robustez y sobriedad son sus principales cualidades.





Ref.: BDR001

Barra de ducha extensible de acero inox. extensible 95/132cm.
 Rociador de acero inox. redondo Ø20cm, extraplano, cromado y antical.
 Soporte teléfono regulable en altura.
 Mango ducha redondo de 3 posiciones.
 Grifería de latón cromado.
 Presión máximo 6 at. mínimo 1 at.
 Caudal medio 12 l/min.
 Distribuidor redondo de latón cromado.
 Flexo reforzado 1,5 m
 Cartucho cerámico de 35 mm.



Grifería con certificación



Ref.: BDR001-1

Monomando de lavabo.
 Cuerpo de grifería en Latón cromado.
 Cartucho cerámico de 35 mm.
 Flexos 3/8



Grifería con certificación



Ref.: BDR001-2

Monomando de bidé.
 Cuerpo de grifería en Latón cromado.
 Cartucho cerámico de 35 mm.
 Flexos 3/8



Grifería con certificación

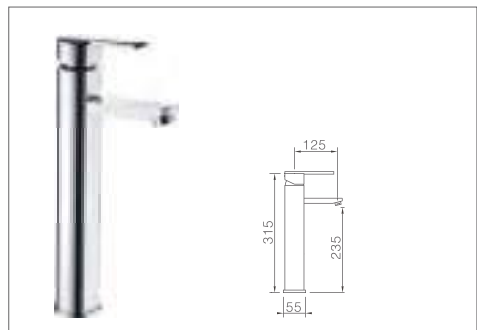

Ref.: BDR001-3

Monomando de lavabo alto.
 Cuerpo de grifería en Latón cromado.
 Cartucho cerámico de 35 mm.
 Flexos 3/8





Ref.: **BDR001-4**

Grifería baño / ducha de latón cromado
 Flexo de acero reforzado 1,8 m
 Soporte para mando de ducha de ABS
 Mango ducha redondo.
 Presión máximo 6 at,mínimo 1 at.
 Caudal medio 12 l/min
 Cartucho monomando cerámico de 35mm

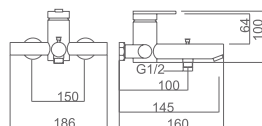

Ref.: **BDR001-5**

Grifería ducha de latón cromado
Flexo de acero reforzado 1,8 m
Soporte para mando de ducha de ABS
Mango ducha redondo.
Presión máximo 6 at, mínimo 1 at.
Caudal medio 12 l/min
Cartucho monomando cerámico de 35mm

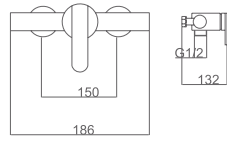

Modelo polivalente y adaptable a cualquier baño. Robustez y sobriedad son sus principales cualidades.





ROMA
NEGRO MATE

SERIE





Ref.: BDR002

Barra de ducha extensible de acero inox. negro mate, extensible 95/127cm.
 Rociador de acero inox. redondo Ø20cm, extraplano, negro mate y antical.
 Soporte teléfono regulable en altura.
 Mango ducha redondo de 3 posiciones.
 Grifería de latón negro mate.
 Presión máximo 6 at. mínimo 1 at.
 Caudal medio 12 l/min.
 Distribuidor redondo de latón negro mate.
 Flexo PVC negro mate 1,5 m
 Cartucho cerámico de 35 mm.



Ref.: BDR002-1

Monomando de lavabo.
 Cuerpo de grifería en Latón negro mate.
 Cartucho cerámico de 35 mm.
 Flexos 3/8



Ref.: BDR002-2

Monomando de bidé.
 Cuerpo de grifería en Latón negro mate.
 Cartucho cerámico de 35 mm.
 Flexos 3/8



DINAMARCA

SERIE





DINAMARCA

SERIE



Modelos de líneas curvas y redondas que aportan al baño confort, elegancia y bienestar.

Ref.: BDR031/CR

Barra de ducha cromo extensible de acero inox. 304 de 88/125cm.
 Rociador de acero inox. redondo Ø20cm,extraplano,cromado y antical.
 Soporte teléfono regulable en altura.
 Mango ducha redondo de 1 posición.
 Grifería de latón cromado.
 Presión máximo 6 at,mínimo 1 at.
 Caudal medio 12 l/min.
 Distribuidor integrado en la grifería.
 Flexo reforzado 1,5 m
 Cartucho monomando cerámico de 35mm.

Ref.: BDR031-1CR

Monomando de lavabo.
 Cuerpo de grifería en Latón cromado.
 Cartucho cerámico de 25 mm.
 Flexos 3/8.

Ref.: BDR031-2CR

Monomando de bidé.
 Cuerpo de grifería en Laton cromado.
 Cartucho cerámico de 25 mm.
 Flexos 3/8.

Ref.: BDR031-3CR

Monomando de lavabo alto.
 Cuerpo de grifería en Latón cromado.
 Cartucho cerámico de 25 mm.
 Flexos 3/8.



DINAMARCA NEGRO MATE

SERIE



DINAMARCA

SERIE

Modelos de líneas curvas y redondas que aportan al baño confort, elegancia y bienestar.





Ref.: **BDR031/NG**

Barra de ducha extensible de acero inox. extensible 88/125 cm, en negro mate.
 Rociador de acero inox. redondo Ø20cm,extraplano,negro mate y antical.
 Soporte teléfono regulable en altura.
 Mango de ducha redondo de 1 posición en negro mate.
 Grifería de latón negro mate.
 Presión máximo 6 at,mínimo 1 at.
 Caudal medio 12 l/min.
 Distribuidor integrado en la grifería, en negro mate.
 Flexo PVC 1,5 m
 Cartucho monomando cerámico de 35mm

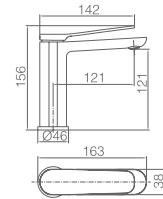
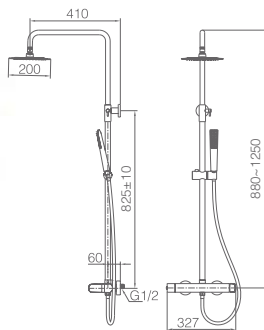

Ref.: **BDR031-1NG**

Monomando de lavabo.
 Cuerpo de grifería en Latón negro mate.
 Cartucho cerámico de 25 mm.
 Flexos 3/8.

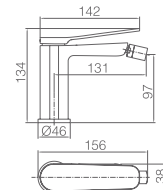

Ref.: **BDR031-2NG**

Monomando de bidé.
 Cuerpo de grifería en Latón negro mate.
 Cartucho cerámico de 25 mm.
 Flexos 3/8.

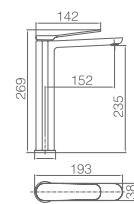

Ref.: **BDR031-3NG**

Monomando de lavabo alto.
 Cuerpo de grifería en Latón negro mate.
 Cartucho cerámico de 25 mm.
 Flexos 3/8.





DINAMARCA

SERIE

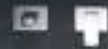

DINAMARCA

BLANCO MATE

SERIE





Ref.: **BDR031/BL**

Barra de ducha extensible de acero inox. extensible 88 / 125 cm, en blanco mate.
 Rociador de acero inox. redondo Ø20cm, extraplano, blanco mate y antical.
 Soporte teléfono regulable en altura.
 Mango de ducha redondo de 1 posición en blanco mate.
 Grifería de latón blanco mate.
 Presión máximo 6 at, mínimo 1 at.
 Caudal medio 12 l/min.
 Distribuidor integrado en la grifería en blanco mate.
 - Flexo PVC de 1,5 m en blanco mate.
 Cartucho monomando cerámico de 35mm

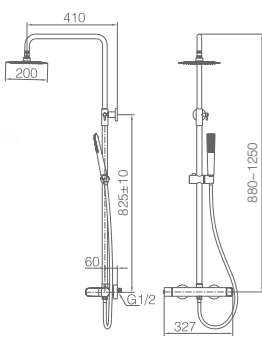
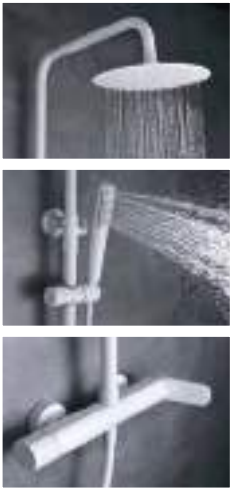

Ref.: **BDR031-1BL**

Monomando de lavabo.
 Cuerpo de grifería en Latón blanco mate.
 Cartucho cerámico de 25 mm.
 Flexos 3/8.

Ref.: **BDR031-2BL**

Monomando de bidé.
 Cuerpo de grifería en Latón blanco mate.
 Cartucho cerámico de 25 mm.
 Flexos 3/8.

Ref.: **BDR031-3BL**

Monomando de lavabo alto.
 Cuerpo de grifería en Latón blanco mate.
 Cartucho cerámico de 25 mm.
 Flexos 3/8.

MILOS

SERIE





Modelos de líneas curvas y redondas que aportan al baño confort, elegancia y bienestar.

MILOS

SERIE

Modelos de líneas curvas y redondas que aportan al baño confort, elegancia y bienestar.





Ref.: **BDY027**

Barra de ducha extensible de acero inox. cromado, extensible 95/132,5 cm.
 Rociador de acero inox. redondo Ø20cm, extraplano, cromado y antical.
 Soporte teléfono regulable en altura.
 Mango ducha redondo de 1 posición.
 Grifería de latón cromado.
 Presión máximo 6 at. mínimo 1 at.
 Caudal medio 12 l/min.
 Distribuidor redondo de latón cromado.
 Flexo reforzado 1,5 m
 Cartucho cerámico de 35 mm.

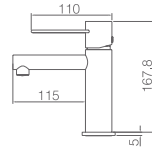

Ref.: **BDY027-1CR**

Monomando de lavabo.
 Cuerpo de grifería en Latón cromado.
 Cartucho cerámico de 25 mm.
 Flexos 3/8

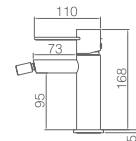

Ref.: **BDY027-2CR**

Monomando de bidé.
 Cuerpo de grifería en Latón cromado.
 Cartucho cerámico de 25 mm.
 Flexos 3/8

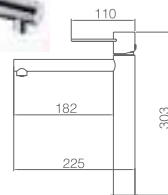

Ref.: **BDY027-3CR**

Monomando de lavabo alto.
 Cuerpo de grifería en Latón cromado.
 Cartucho cerámico de 25 mm.
 Flexos 3/8





MILOS NEGRO MATE

SERIE



MILOS

NEGRO MATE

SERIE



Modelos de líneas curvas y redondas que aportan al baño confort, elegancia y bienestar.



Ref.: **BDY027/NG**

Barra de ducha extensible de acero inox. negro mate, extensible 95/132,5 cm.
 Rociador de acero inox. redondo Ø20cm, extraplano, negro mate y antical.
 Soporte teléfono regulable en altura.
 Mango ducha redondo de 1 posición.
 Grifería de latón negro mate.
 Presión máximo 6 at. mínimo 1 at.
 Caudal medio 12 l/min.
 Distribuidor redondo de latón negro mate.
 Flexo reforzado de PVC negro mate 1,5 m
 Cartucho cerámico de 35 mm.

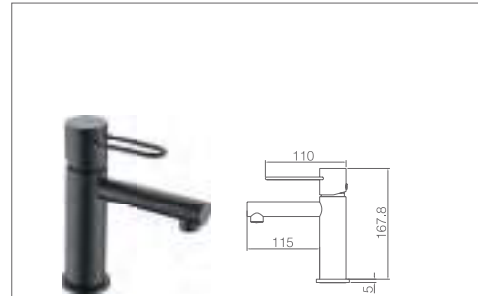

Ref.: **BDY027-1NG1**

Monomando de lavabo.
 Cuerpo de grifería en Latón negro mate.
 Cartucho cerámico Citec de 25 mm.
 Flexos 3/8

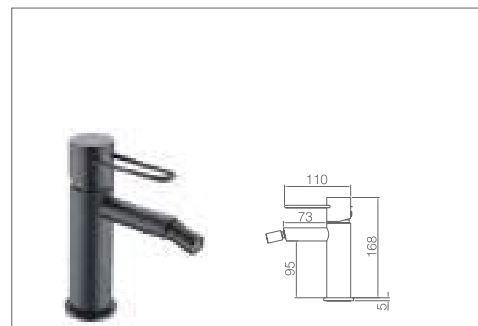

Ref.: **BDY027-2NG**

Monomando de bidé.
 Cuerpo de grifería en Latón negro mate.
 Cartucho cerámico Citec de 25 mm.
 Flexos 3/8



Ref.: **BDY027-3NG**

Monomando de lavabo alto.
 Cuerpo de grifería en Latón negro mate.
 Cartucho cerámico Citec de 25 mm.
 Flexos 3/8



MILOS

NEGRO ORO ROSA

SERIE





MILOS

NEGRO ORO ROSA

SERIE



Modelos de líneas curvas y redondas que aportan al baño confort, elegancia y bienestar.

Ref.: BDY027/NOR

Barra de ducha extensible de acero inox. negro mate, extensible 95/132,5 cm.
 Rociador de acero inox. redondo Ø20cm, extraplano, oro rosa y antical.
 Soporte teléfono regulable en altura.
 Mango ducha redondo de 1 posición.
 Grifería de latón negro oro rosa.
 Presión máximo 6 at. mínimo 1 at.
 Caudal medio 12 l/min.
 Distribuidor redondo de latón negro mate.
 Flexo reforzado de PVC negro mate 1,5 m
 Cartucho cerámico de 35 mm.

Ref.: BDY027-1NOR3

Monomando de lavabo.
 Cuerpo de grifería en Latón negro oro rosa.
 Cartucho cerámico de 25 mm.
 Flexos 3/8

Ref.: BDY027-2NOR

Monomando de bidé.
 Cuerpo de grifería en Latón negro oro rosa.
 Cartucho cerámico de 25 mm.
 Flexos 3/8

Ref.: BDY027-3NOR

Monomando de lavabo alto.
 Cuerpo de grifería en Latón negro oro rosa.
 Cartucho cerámico de 25 mm.
 Flexos 3/8



MILOS

BLANCO MATE

SERIE

Modelos de líneas curvas y redondas que aportan al baño confort, elegancia y bienestar.



MILOS

BLANCO MATE

SERIE

Modelos de líneas curvas y redondas que aportan al baño confort, elegancia y bienestar.





Ref.: **BDY027/BL**

Barra de ducha extensible de acero inox. blanco mate, extensible 95/132,5 cm.
 Rociador de acero inox. redondo Ø20cm, extraplano, blanco mate y antical.
 Soporte teléfono regulable en altura.
 Mango ducha redondo de 1 posición.
 Grifería de latón blanco mate.
 Presión máximo 6 at. mínimo 1 at.
 Caudal medio 12 l/min.
 Distribuidor redondo de latón blanco mate.
 Flexo reforzado PVC blanco mate 1,5 m
 Cartucho cerámico de 35 mm.

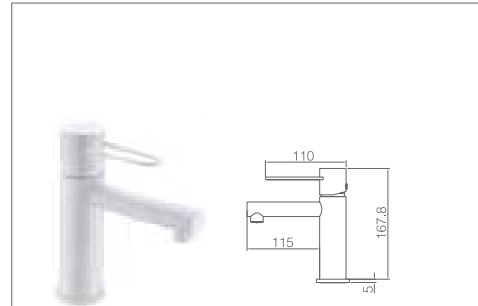

Ref.: **BDY027-1BL1**

Monomando de lavabo.
 Cuerpo de grifería en Latón blanco mate.
 Cartucho cerámico de 25 mm.
 Flexos 3/8

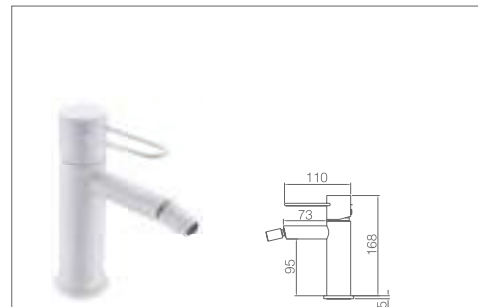

Ref.: **BDY027-2BL**

Monomando de bidé.
 Cuerpo de grifería en Latón blanco mate.
 Cartucho cerámico de 25 mm.
 Flexos 3/8

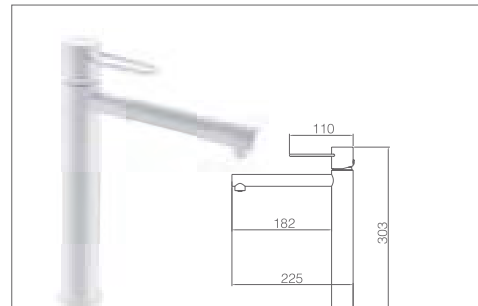

Ref.: **BDY027-3BL**

Monomando de lavabo alto.
 Cuerpo de grifería en Latón blanco mate.
 Cartucho cerámico de 25 mm.
 Flexos 3/8





ESCOCIA

SERIE



Modelos de líneas curvas y redondas que aportan al baño confort, elegancia y bienestar.

ESCOCIA

SERIE

Modelos de líneas curvas y redondas que aportan al baño confort, elegancia y bienestar.



Ref.: BDSC024

Barra de ducha extensible de acero inox. extensible 87/123 cm.
 Rociador de acero inox. redondo Ø20cm, extraplano, cromado y antical.
 Soporte teléfono regulable en altura.
 Mango ducha redondo de 3 posiciones.
 Grifería de latón cromado.
 Presión máximo 6 at. mínimo 1 at.
 Caudal medio 12 l/min.
 Distribuidor redondo de latón cromado.
 Flexo reforzado 1,5 m
 Cartucho cerámico de 35 mm.

Sistema desvío de agua de mango a rociador: girar y bajar.

Ref.: BDSC024-1

Monomando de lavabo.
 Cuerpo de grifería en Latón cromado.
 Cartucho cerámico de 35 mm.
 Flexos 3/8

Ref.: BDSC024-2

Monomando de bidé.
 Cuerpo de grifería en Latón cromado.
 Cartucho cerámico de 35 mm.
 Flexos 3/8

Ref.: BDSC024-3

Monomando de lavabo.
 Cuerpo de grifería en Latón cromado.
 Cartucho cerámico de 35 mm.
 Flexos 3/8



LUXOR

SERIE

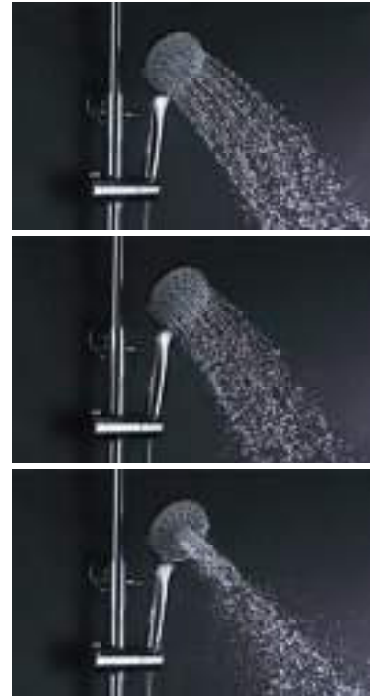

Modelos de líneas curvas y redondas que aportan al baño confort, elegancia y bienestar.



LUXOR

SERIE





Ref.: BDX023

Barra de ducha extensible de acero inox. extensible 95/133cm.
 Rociador de acero inox. redondo Ø20cm, extraplano, cromado y antical.
 Soporte teléfono regulable en altura.
 Mango ducha redondo de 3 posiciones.
 Grifería de latón cromado.
 Presión máximo 6 at. mínimo 1 at.
 Caudal medio 12 l/min.
 Distribuidor redondo de latón cromado.
 Flexo reforzado 1,5 m
 Cartucho cerámico Citecde 25 mm.



Ref.: BDX023-1

Monomando de lavabo.
 Cuerpo de grifería en Latón cromado.
 Cartucho cerámico Citec de 25 mm.
 Flexos 3/8



Ref.: BDX023-2

Monomando de bidé.
 Cuerpo de grifería en Laton cromado.
 Cartucho cerámico Citec de 25 mm.
 Flexos 3/8



Ref.: BDX023-3

Monomando de lavabo.
 Cuerpo de grifería en Latón cromado.
 Cartucho cerámico Citec de 25 mm.
 Flexos 3/8





LUXOR NEGRO MATE

SERIE



Modelos de líneas curvas y redondas que aportan al baño confort, elegancia y bienestar.





LUXOR

NEGRO MATE

SERIE





Ref.: **BDX023/NG**

Barra de ducha extensible de acero inox. negro mate, extensible 95/133 cm.
 Rociador de acero inox. redondo Ø20cm, extraplano, negro mate y antical.
 Soporte teléfono regulable en altura.
 Mango ducha redondo de 3 posiciones.
 Grifería de latón negro mate.
 Presión máximo 6 at. mínimo 1 at.
 Caudal medio 12 l/min.
 Distribuidor redondo de latón negro mate.
 Flexo PVC negro mate 1,5 m
 Cartucho cerámico Citec de 25 mm.



Ref.: **BDX023-1NG8**

Monomando de lavabo.
 Cuerpo de grifería en Latón negro mate.
 Cartucho cerámico Citec de 25 mm.
 Flexos 3/8



Ref.: **BDX023-2NG**

Monomando de bidé.
 Cuerpo de grifería en Latón negro mate.
 Cartucho cerámico Citec de 25 mm.
 Flexos 3/8



Ref.: **BDX023-3NG**

Monomando de lavabo.
 Cuerpo de grifería en Latón negro mate.
 Cartucho cerámico Citec de 25 mm.
 Flexos 3/8





LUXOR BLANCO MATE

SERIE



LUXOR

BLANCO MATE

SERIE



Ref.: BDX023/BL

Barra de ducha extensible de acero inox. blanco mate, extensible 95/133cm.
 Rociador de acero inox. redondo Ø20cm, extraplano, negro mate y antical.
 Soporte teléfono regulable en altura.
 Mango ducha redondo de 3 posiciones.
 Grifería de latón blanco mate.
 Presión máximo 6 at. mínimo 1 at.
 Caudal medio 12 l/min.
 Distribuidor redondo de latón blanco mate.
 Flexo PVC blanco mate 1,5 m
 Cartucho cerámico Citec de 25 mm.

Ref.: BDX023-1BL8

Monomando de lavabo.
 Cuerpo de grifería en Latón blanco mate.
 Cartucho cerámico Citec de 25 mm.
 Flexos 3/8

Ref.: BDX023-2BL

Monomando de bidé.
 Cuerpo de grifería en Latón blanco mate.
 Cartucho cerámico Citec de 25 mm.
 Flexos 3/8

Ref.: BDX023-3BL

Monomando de lavabo.
 Cuerpo de grifería en Latón blanco mate.
 Cartucho cerámico Citec de 25 mm.
 Flexos 3/8





CR/NG



ELBA
CROMO / NEGRO
SERIE

ELBA

CROMO / NEGRO

SERIE







940-1300

Ref.: BDA022/NG

Barra de ducha extensible de acero inox. cromo, extensible 94/130cm.
 Rociador de acero inox. redondo Ø20cm, extraplano, cromo y antical.
 Soporte teléfono regulable en altura.
 Mango ducha redondo de 3 posiciones.
 Grifería de latón cromo / negro mate.
 Presión máximo 6 at. mínimo 1 at.
 Caudal medio 12 l/min.
 Distribuidor redondo de latón cromo.
 Flexo reforzado cromado 1,5 m
 Cartucho cerámico de 35 mm.



Grifería con certificación



Ref.: BDA022-1NG

Monomando de lavabo.
 Cuerpo de grifería en Latón cromo / negro mate.
 Cartucho cerámico de 35 mm.
 Flexos 3/8



Grifería con certificación





Ref.: BDA022-2NG

Monomando de bidé.
 Cuerpo de grifería en Latón cromo / negro mate.
 Cartucho cerámico de 35 mm.
 Flexos 3/8



Grifería con certificación





Ref.: BDA022-3NG

Monomando de lavabo alto.
 Cuerpo de grifería en Latón cromo / negro mate.
 Cartucho cerámico de 35 mm.
 Flexos 3/8



Grifería con certificación





ELBA

CROMO / BLANCO

SERIE



ELBA

CROMO / BLANCO

SERIE







940-1300

Ref.: BDA022/BL

Barra de ducha extensible de acero inox. cromo, extensible 94/130cm.
 Rociador de acero inox. redondo Ø20cm, extraplano, cromo y antical.
 Soporte teléfono regulable en altura.
 Mango ducha redondo de 3 posiciones.
 Grifería de latón cromo / blanco.
 Presión máximo 6 at. mínimo 1 at.
 Caudal medio 12 l/min.
 Distribuidor redondo de latón cromo.
 Flexo reforzado 1,5 m
 Cartucho cerámico de 35 mm.



Grifería con certificación



Ref.: BDA022-1BL7

Monomando de lavabo.
 Cuerpo de grifería en Latón cromo / blanco.
 Cartucho cerámico de 35 mm.
 Flexos 3/8



Grifería con certificación





Ref.: BDA022-2BL

Monomando de bidé.
 Cuerpo de grifería en Latón cromo / blanco.
 Cartucho cerámico de 35 mm.
 Flexos 3/8



Grifería con certificación





Ref.: BDA022-3B

Monomando de lavabo alto.
 Cuerpo de grifería en Latón cromo / blanco.
 Cartucho cerámico de 35 mm.
 Flexos 3/8



Grifería con certificación



MILAN

SERIE



Líneas suaves y redondas, una exquisitez para los sentidos, un conjunto polivalente que puede ser instalado en multitud de baños.









Ref. : BDM002

Barra de ducha extensible de acero inox. extensible 94/132cm.
 Rociador de acero inox. redondo Ø20cm,extraplano,cromado y antical.
 Soporte teléfono regulable en altura.
 Mango ducha redondo.
 Grifería de latón cromado.
 Presión máximo 6 at. mínimo 1 at.
 Caudal medio 12 l/min.
 Distribuidor redondo de latón cromado.
 Flexo reforzado 1,5 m
 Cartucho monomando cerámico 35mm



Ref. : BDM002-1

Monomando de lavabo.
 Cuerpo de grifería en Latón cromado.
 Cartucho cerámico de 35 mm.
 Flexos 3/8.



Ref. : BDM002-2

Monomando de bidé.
 Cuerpo de grifería en Latón cromado.
 Cartucho cerámico de 35 mm.
 Flexos 3/8.





PARIS

SERIE



La evolución hacia el diseño y la exquisitez, con un marcado carácter.







Ref. : BDP004

Barra de ducha extensible de acero inox. extensible 94/132cm.
 Rociador de acero inox. redondo Ø20 cm,extraplano,cromado y antical.
 Soporte teléfono regulable en altura.
 Mango ducha redondo 3 posiciones.
 Grifería de latón cromado.
 Presión máximo 6 at. mínimo 1 at.
 Caudal medio 12 l/min.
 Distribuidor redondo de latón cromado.
 Flexo reforzado 1,5 m.
 Cartucho monomando cerámico 35mm.



Ref. : BDP004-1

Monomando de lavabo.
 Cuerpo de grifería en Latón cromado.
 Cartucho cerámico de 35 mm.
 Flexos 3/8.



Ref. : BDP004-2

Monomando de bidé.
 Cuerpo de grifería en Latón cromado.
 Cartucho cerámico de 35 mm.
 Flexos 3/8.





SINTRA

SERIE



Una serie, en la que las líneas tradicionales han evolucionado para dar paso a una serie competitiva y sólida.



SINTRA

SERIE





Ref.: **BDS008**

Barra de ducha extensible de acero inox. extensible 94/132 cm.
 Rociador de acero inox. redondo Ø20cm,extraplano,cromado y antical.
 Soporte teléfono regulable en altura.
 Mango ducha redondo 3 posiciones.
 Grifería de latón cromado.
 Presión máximo 6 at,mínimo 1 at.
 Caudal medio 12 l/min.
 Distribuidor redondo de latón cromado.
 Flexo reforzado 1,5 m Cartucho monomando cerámico 35mm



Grifería con certificación

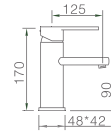

Ref.: **BDS008-1**

Monomando de lavabo.
 Cuerpo de grifería en Latón cromado.
 Cartucho cerámico de 35 mm.
 Flexos 3/8.



Grifería con certificación

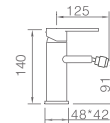

Ref.: **BDS008-2**

Monomando de bidé.
 Cuerpo de grifería en Latón cromado.
 Cartucho cerámico de 35 mm.
 Flexos 3/8.



Grifería con certificación

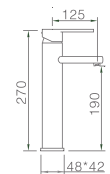

Ref.: **BDS008-3**

Monomando de lavabo.
 Cuerpo de grifería en Latón cromado.
 Cartucho cerámico de 35 mm.
 Flexos 3/8.



8 478023 772914



NASSAU

SERIE



Producto de nueva generación que introduce novedades en el diseño y en el concepto de uso, como es la incorporación del distribuidor en la grifería.







NASSAU

SERIE

NASSAU

SERIE





Ref.: BDU014

Barra de ducha extensible de acero inox. extensible 87/123cm.
 Rociador de acero inox. redondo,extraplano,cromado y antical.
 Soporte teléfono regulable en altura.
 Mango ducha redondo de 3 posiciones.
 Grifería de latón cromado.
 Presión máximo 6 at,mínimo 1 at.
 Caudal medio 12 l/min.
 Distribuidor integrado en la grifería.
 Flexo reforzado 1,5 m
 Cartucho monomando cerámico de 35mm.



Ref.: BDU014-1

Monomando de lavabo.
 Cuerpo de grifería en Latón cromado.
 Cartucho cerámico de 35 mm.
 Flexos 3/8.



Ref.: BDU014-2

Monomando de bidé.
 Cuerpo de grifería en Laton cromado.
 Cartucho cerámico de 35 mm.
 Flexos 3/8.



Ref.: BDU014-3

Monomando de lavabo.
 Cuerpo de grifería en Latón cromado.
 Cartucho cerámico de 35 mm.
 Flexos 3/8.





MADRID

SERIE



Ref. : GDM001

Mango ducha redondo de 3 posiciones.

Barra de ducha de acero.

Grifería de latón cromado.

Presión máximo 6 at. mínimo 1 at.

Caudal medio 12 l/min.

Flexo reforzado 1,5 m.

Cartucho monomando cerámico de 35mm.



Grifería con
certificación







MONOMANDO DE LAVABO

OLIMPO

SERIE





OLIMPO

SERIE



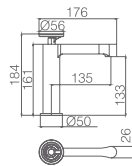

Ref.: **BDC033-1CR**

Monomando de lavabo.
Cuerpo de grifería en Latón cromado.
Cartucho cerámico de 25 mm.
Flexos 3/8.

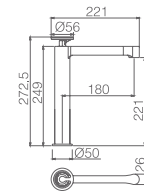

Ref.: **BDC033-3CR**

Monomando de lavabo alto.
Cuerpo de grifería en Latón cromado.
Cartucho cerámico de 25 mm.
Flexos 3/8.

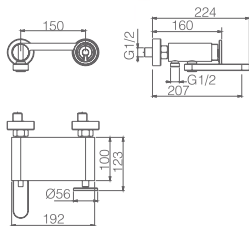

Ref.: **BDC033-4CR**

Grifería baño/ducha latón cromado.
Soporte para mango de ducha de ABS.
Mango ducha redondo.
Presión máximo 6 at. mínimo 1 at.
Caudal medio 12 l/min.
Flexo reforzado PVC 1,7m.
Cartucho monomando cerámico de 25mm.

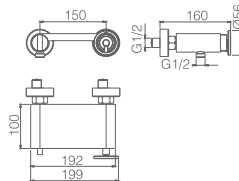

Ref.: **BDC033-5CR**

Grifería ducha latón cromado.
Soporte para mango de ducha de ABS.
Mango ducha redondo.
Presión máximo 6 at. mínimo 1 at.
Caudal medio 12 l/min.
Flexo reforzado PVC 1,7m.
Cartucho monomando cerámico de 25mm.



OLIMPO NEGRO ORO ROSA

SERIE





OLIMPO

SERIE



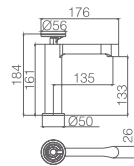

Ref.: **BDC033-1NOR**

Monomando de lavabo.
Cuerpo de grifería en Latón negro mate, oro rosa.
Cartucho cerámico de 25 mm.
Flexos 3/8.

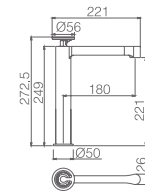

Ref.: **BDC033-3NOR**

Monomando de lavabo alto.
Cuerpo de grifería en Latón negro mate, oro rosa.
Cartucho cerámico de 25 mm.
Flexos 3/8.

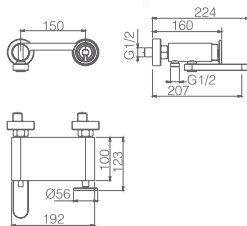

Ref.: **BDC033-4NOR**

Grifería baño/ducha latón negro mate, oro rosa.
Soporte para mango de ducha de ABS.
Mango ducha redondo.
Presión máximo 6 at. mínimo 1 at.
Caudal medio 12 l/min.
Flexo reforzado PVC 1,7 m.
Cartucho monomando cerámico de 25mm.

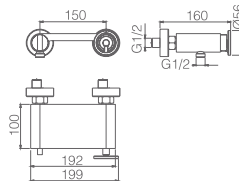

Ref.: **BDC033-5NOR**

Grifería ducha latón negro mate, oro rosa.
Soporte para mango de ducha de ABS.
Mango ducha redondo.
Presión máximo 6 at. mínimo 1 at.
Caudal medio 12 l/min.
Flexo reforzado PVC 1,7m.
Cartucho monomando cerámico de 25mm.



OLIMPO NEGRO MATE

SERIE

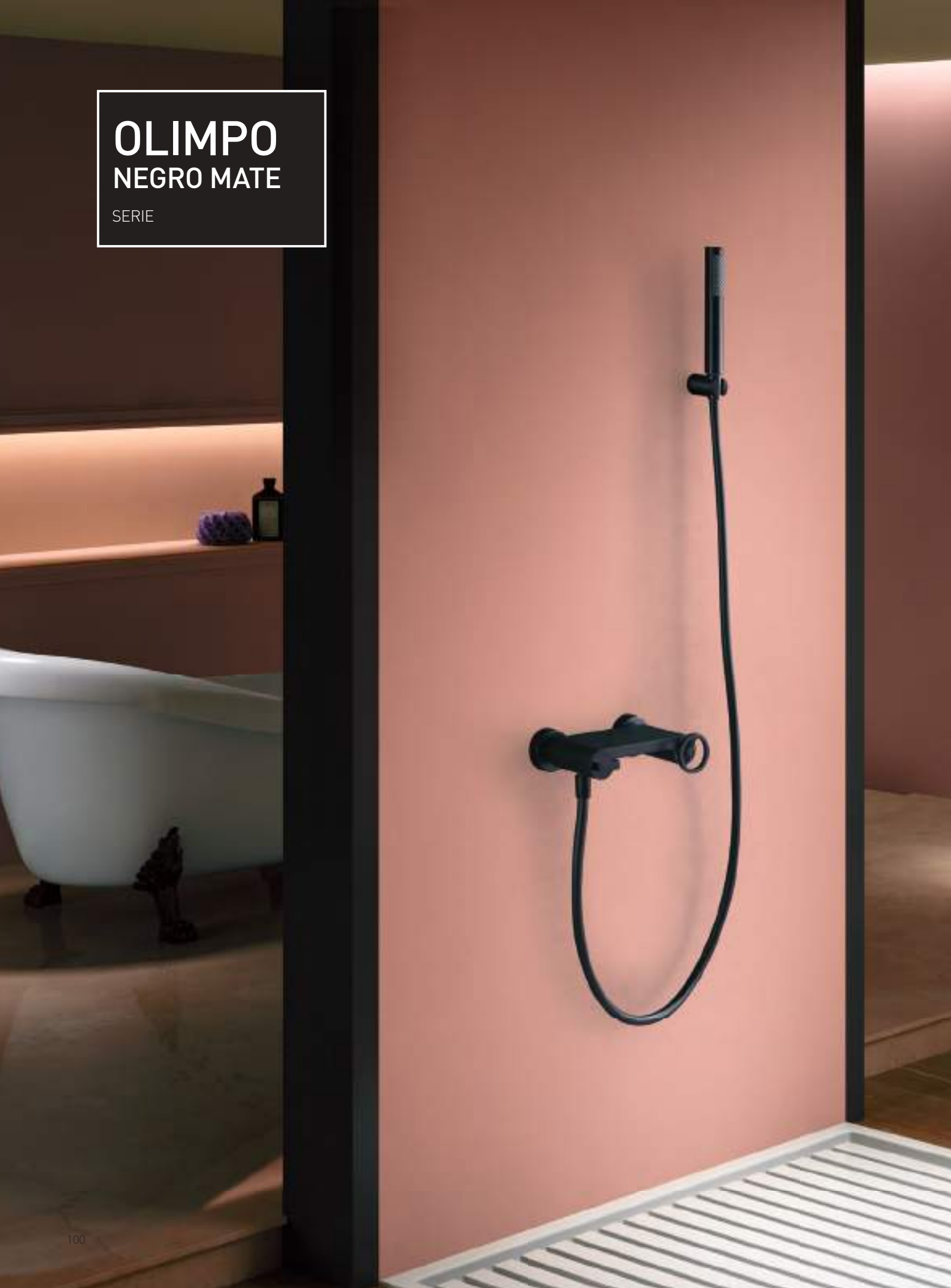



OLIMPO

SERIE



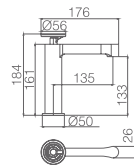

Ref.: **BDC033-1NG**

Monomando de lavabo.
Cuerpo de grifería en Latón negro mate.
Cartucho cerámico de 25 mm.
Flexos 3/8.

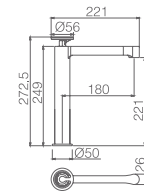

Ref.: **BDC033-3NG**

Monomando de lavabo alto.
Cuerpo de grifería en Latón negro mate.
Cartucho cerámico de 25 mm.
Flexos 3/8.

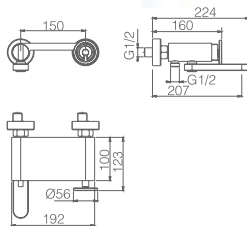

Ref.: **BDC033-4NG**

Grifería baño/ducha latón negro mate.
Soporte para mango de ducha de ABS.
Mango ducha redondo.
Presión máximo 6 at. mínimo 1 at.
Caudal medio 12 l/min.
Flexo reforzado PVC 1,7 m.
Cartucho monomando cerámico de 25mm.

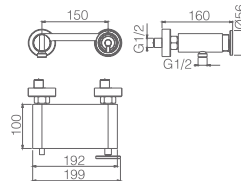

Ref.: **BDC033-5NG**

Grifería ducha latón negro mate.
Soporte para mango de ducha de ABS.
Mango ducha redondo.
Presión máximo 6 at. mínimo 1 at.
Caudal medio 12 l/min.
Flexo reforzado PVC 1,7m.
Cartucho monomando cerámico de 25mm.





ACERO
S 316
INOX

MOSCU

SERIE



MOSCU

SERIE

10 ANOS
GARANTÍA
ANTICORROSIÓN
ACERO INOX. S316



Válido tanto para interior como exterior alta resistencia



MOSCU

SERIE



Válido tanto para interior como exterior.
Alta resistencia





Ref.: BDK034

Barra de ducha de acero S316. extensible 98/140cm, máxima calidad anticorrosión y alta resistencia.
 Rociador de acero S316. redondo Ø20cm, extraplano y antical.
 Soporte teléfono regulable en altura.
 Mango ducha redondo de 1 posición de acero S316.
 Grifería de acero S316.
 Presión máximo 6 at, mín 1 at.
 Caudal medio 12 l/min.
 Distribuidor integrado en la grifería de acero S316.
 Flexo reforzado 1,5 mts de acero S316
 Cartucho monomando cerámico de 35mm.
 VALIDO TANTO PARA INTERIOR COMO PARA EXTERIOR



Ref.: BDK034-1

Monomando de lavabo.
 Cuerpo de grifería en acero S316, máxima calidad anticorrosión y alta resistencia.
 Cartucho cerámico de 25 mm.
 Flexos 3/8.



Ref.: BDK034-2

Monomando de bidé.
 Cuerpo de grifería en acero S316, máxima calidad anticorrosión y alta resistencia.
 Cartucho cerámico de 25 mm.
 Flexos 3/8.



CÓRCEGA

SERIE

Ref. : **BBECO1**

Grifería exenta de bañera en latón cromado.
Cartucho cerámico de 35 mm sedal.
Mango de ducha redondo.
Flexo de pvc.
Caja de registro a suelo.



8

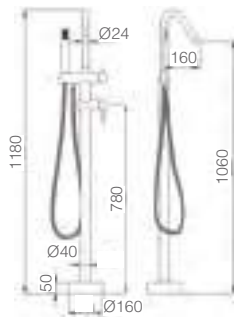





CÓRCEGA

NEGRO MATE

SERIE

Ref. : BBEC01/NG

Grifería exenta de bañera en latón negro mate.
Cartucho cerámico de 35 mm sedal.
Mango de ducha redondo.
Flexo de pvc.
Caja de registro a suelo.

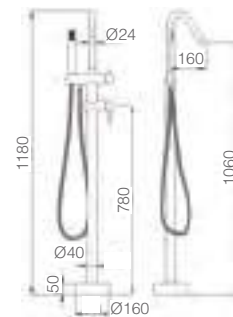



TEIDE

SERIE



TEIDE

SERIE







TEIDE

SERIE



Ref.: **BDT021**

Barra de ducha extensible de acero inox. extensible 94/130 cm.
 Rociador de acero inox. redondo 20cm, extraplano, cromado y antical.
 Soporte teléfono regulable en altura.
 Mango ducha redondo.
 Grifería de latón cromado.
 Presión máximo 6 at. mínimo 1 at.
 Caudal medio 12 l/min.
 Distribuidor redondo de latón cromado.
 Flexo reforzado 1,5 m
 Cartucho monomando cerámico 35 mm.

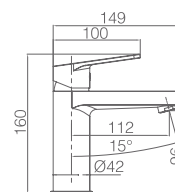

Ref.: **BDT021-1**

Monomando de lavabo.
 Cuerpo de grifería en Latón cromado.
 Cartucho cerámico de 35 mm.
 Flexos 3/8.

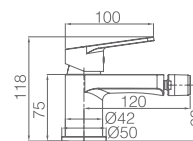

Ref.: **BDT021-2**

Monomando de bidé.
 Cuerpo de grifería en Latón cromado.
 Cartucho cerámico de 35 mm.
 Flexos 3/8.



**GRIFERÍA
MONOMANDO
CUADRADA**





Nueva creación de IMEX de líneas curvas y apuradas con un pulido y un cromado excepcionales.



VALENCIA

SERIE



Modernidad y Calidez.
Modelo de diseño recto, cuadrado, con una gran versatilidad.





Serie de líneas rectas y cuadradas que proporcionan estilo y diseño en cualquier baño.



Ref.: **BDV003**

Barra de ducha extensible de acero inox. extensible 92/136 cm.
 Rociador de acero inox. cuadrado 20cm,extraplano,cromado y antical.
 Soporte teléfono regulable en altura.
 Mango ducha cuadrado.
 Grifería de latón cromado.
 Presión máximo 6 at. mínimo 1 at.
 Caudal medio 12 l/min.
 Distribuidor cuadrado de latón cromado.
 Flexo reforzado 1,5 m
 Cartucho monomando cerámico 35 mm.

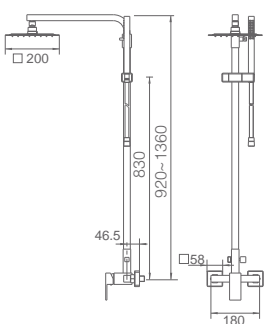

Ref.: **BDV003-1**

Monomando de lavabo.
 Cuerpo de grifería en Latón cromado.
 Cartucho cerámico de 25 mm.
 Flexos 3/8.

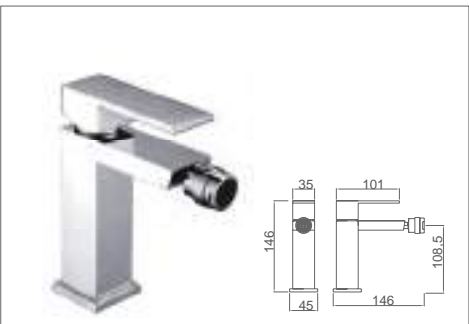
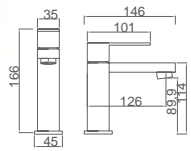

Ref.: **BDV003-2**

Monomando de bidé.
 Cuerpo de grifería en Latón cromado.
 Cartucho cerámico de 25 mm.
 Flexos 3/8

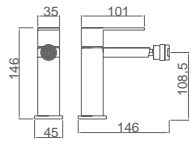

Ref.: **BDV003-3**

Monomando de lavabo.
 Cuerpo de grifería en Latón cromado.
 Cartucho cerámico de 25 mm.
 Flexos 3/8

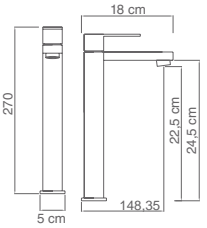



Ref.: **BDV003-4**

Grifería monomando de baño / ducha latón cromado.
 Soporte mango de ducha.
 Mango ducha cuadrado.
 Presión máximo 6 at, mínimo 1 at.
 Caudal medio 12 l/min.
 Flexo reforzado extensible 1,7 / 1,9 m
 Cartucho monomando cerámico de 35mm.



Grifería con certificación

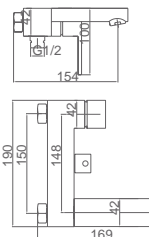



Ref.: **BDV003-5**

Grifería monomando de ducha latón cromado.
 Soporte mango de ducha.
 Mango ducha cuadrado.
 Presión máximo 6 at. mínimo 1 at.
 Caudal medio 12 l/min.
 Flexo reforzado extensible 1,7 / 1,9 m
 Cartucho monomando cerámico de 35mm.

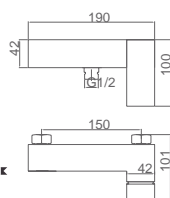

SUECIA

SERIE





SUECIA

SERIE



Serie de líneas rectas y cuadradas que proporcionan estilo y diseño en cualquier baño.





Ref.: **BDC032/CR**

Barra de ducha extensible de acero inox. 304, cromado, extensible 87/133 cm.
 Rociador de acero inox. cuadrado 20cm, extraplano, cromado y antical.
 Soporte teléfono regulable en altura.
 Mango ducha cuadrado.
 Grifería de latón cromado.
 Presión máximo 6 at. mínimo 1 at.
 Caudal medio 12 l/min.
 Distribuidor cuadrado de latón cromado integrado en la grifería.
 Flexo reforzado 1,5 m
 Cartucho monomando cerámico 35 mm.

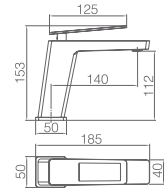

Ref.: **BDC032-1CR**

Monomando de lavabo.
 Cuerpo de grifería en Latón cromado.
 Cartucho cerámico de 25 mm.
 Flexos 3/8.

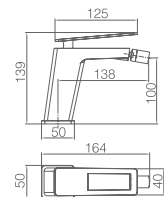

Ref.: **BDC032-2CR**

Monomando de bidé.
 Cuerpo de grifería en Latón cromado.
 Cartucho cerámico de 25 mm.
 Flexos 3/8

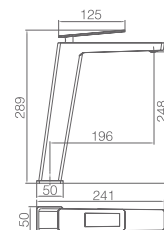

Ref.: **BDC032-3CR**

Monomando de lavabo alto.
 Cuerpo de grifería en Latón cromado.
 Cartucho cerámico de 25 mm.
 Flexos 3/8





SUECIA NEGRO MATE

SERIE



SUECIA

SERIE





Ref.: **BDC032/NG**

Barra de ducha extensible de acero inox. negro mate extensible 87/133cm.
 Rociador de acero inox. cuadrado 20cm, extraplano, negro mate y antical.
 Soporte teléfono regulable en altura.
 Mango ducha cuadrado.
 Grifería de latón negro mate.
 Presión máximo 6 at. mínimo 1 at.
 Caudal medio 12 l/min.
 Distribuidor cuadrado de latón negro mate, integrado en la grifería.
 Flexo reforzado PVC 1,5 m
 Cartucho monomando cerámico 35 mm.

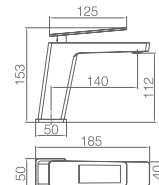

Ref.: **BDC032-1NG**

Monomando de lavabo.
 Cuerpo de grifería en Latón negro mate.
 Cartucho cerámico de 25 mm.
 Flexos 3/8.

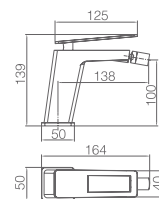

Ref.: **BDC032-2NG**

Monomando de bidé.
 Cuerpo de grifería en Latón negro mate.
 Cartucho cerámico de 25 mm.
 Flexos 3/8

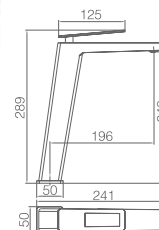

Ref.: **BDC032-3NG**

Monomando de lavabo alto.
 Cuerpo de grifería en Latón negro mate.
 Cartucho cerámico de 25 mm.
 Flexos 3/8



SUECIA

NEGRO ORO ROSA

SERIE





SUECIA

SERIE



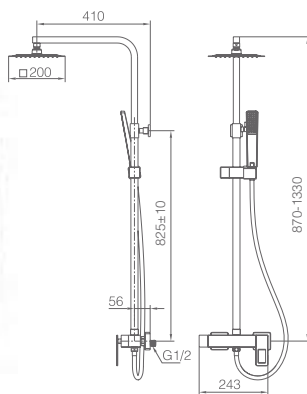

Ref.: **BDC032/NOR**

Barra de ducha de acero inox. negro mate, extensible 87/133 cm.
 Rociador de acero inox. cuadrado 20cm, extraplano, oro rosa y antical.
 Soporte teléfono regulable en altura.
 Mango ducha cuadrado.
 Grifería de latón negro, oro rosa.
 Presión máximo 6 at. mínimo 1 at.
 Caudal medio 12 l/min.
 Distribuidor cuadrado de latón oro rosa, integrado en la grifería.
 Flexo reforzado PVC 1,5 m
 Cartucho monomando cerámico 35 mm.

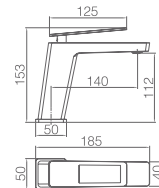

Ref.: **BDC032-1NOR**

Monomando de lavabo.
 Cuerpo de grifería en Latón negro, oro rosa.
 Cartucho cerámico de 25 mm.
 Flexos 3/8

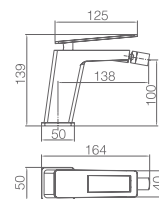

Ref.: **BDC032-2NOR**

Monomando de bidé.
 Cuerpo de grifería en Latón negro, oro rosa.
 Cartucho cerámico de 25 mm.
 Flexos 3/8

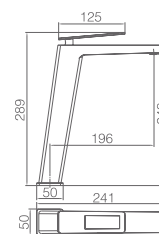

Ref.: **BDC032-3NOR**

Monomando de lavabo alto.
 Cuerpo de grifería en Latón negro, oro rosa.
 Cartucho cerámico de 25 mm.
 Flexos 3/8



SUECIA NEGRO ORO

SERIE





SUECIA

SERIE



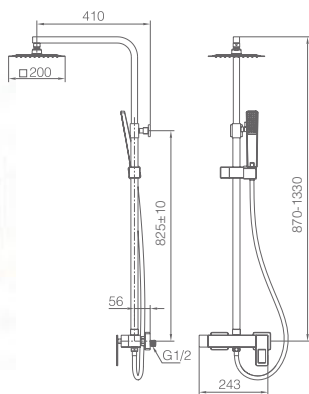

Ref.: **BDC032/NGOLD**

Barra de ducha de acero inox. negro mate, extensible 87/133 cm.
 Rociador de acero inox. cuadrado 20cm, extraplano, oro brillo y antical.
 Soporte teléfono regulable en altura.
 Mango ducha cuadrado.
 Grifería de latón negro, oro brillo.
 Presión máximo 6 at. mínimo 1 at.
 Caudal medio 12 l/min.
 Distribuidor cuadrado de latón oro brillo, integrado en la grifería.
 Flexo reforzado PVC 1,5 m
 Cartucho monomando cerámico 35 mm.

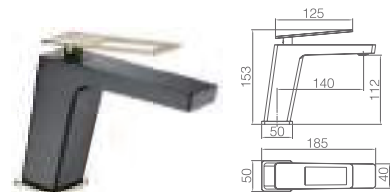

Ref.: **BDC032-1NGOLD**

Monomando de lavabo.
 Cuerpo de grifería en Latón negro, oro brillo.
 Cartucho cerámico de 25 mm.
 Flexos 3/8

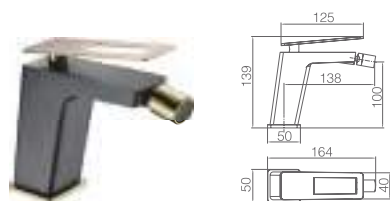

Ref.: **BDC032-2NGOLD**

Monomando de bidé.
 Cuerpo de grifería en Latón negro, oro brillo.
 Cartucho cerámico de 25 mm.
 Flexos 3/8

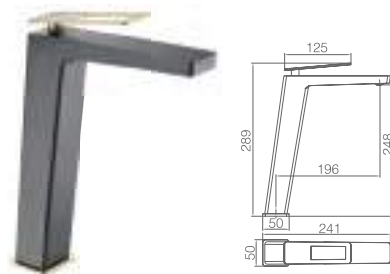

Ref.: **BDC032-3NGOLD**

Monomando de lavabo alto.
 Cuerpo de grifería en Latón negro, oro brillo.
 Cartucho cerámico de 25 mm.
 Flexos 3/8





ART

SERIE



ART

SERIE



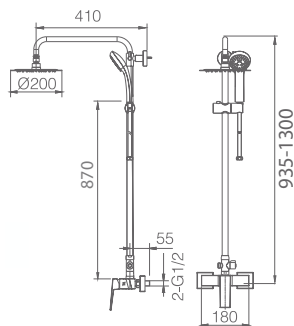

Ref.: **BDAR025**

Barra de ducha extensible de acero inox. extensible 93,5/130cm.
 Rociador de acero inox. cuadrado 20cm,extraplano,cromado y antical.
 Soporte teléfono regulable en altura.
 Mango ducha cuadrado.
 Grifería de latón cromado.
 Presión máximo 6 at. mínimo 1 at.
 Caudal medio 12 l/min.
 Distribuidor redondo de latón cromado.
 Flexo reforzado 1,5 m
 Cartucho monomando cerámico 35 mm.

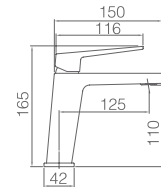

Ref.: **BDAR025-1**

Monomando de lavabo.
 Cuerpo de grifería en Latón cromado.
 Cartucho cerámico Citec de 25 mm.
 Flexos 3/8.

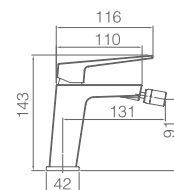

Ref.: **BDAR025-2**

Monomando de bidé.
 Cuerpo de grifería en Laton cromado.
 Cartucho cerámico Citec de 25 mm.
 Flexos 3/8

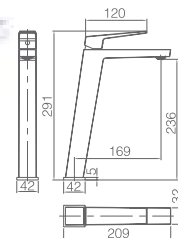

Ref.: **BDAR025-34**

Monomando de lavabo alto.
 Cuerpo de grifería en Laton cromado.
 Cartucho cerámico de 25 mm.
 Flexos 3/8











ART BLANCO MATE

SERIE

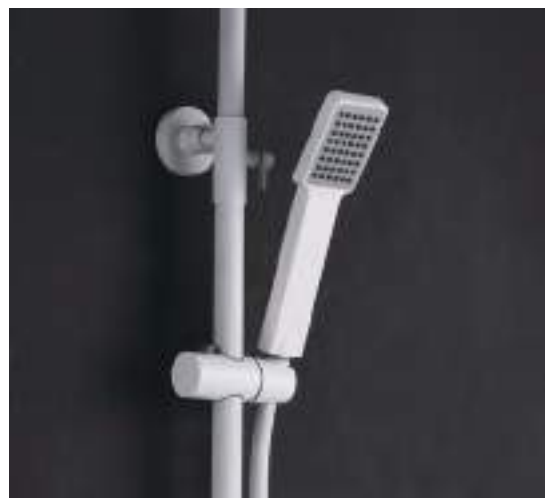



Ref.: BDAR025/BL

Barra de ducha extensible de acero inox. blanco mate extensible 93,5/130cm.
 Rociador de acero inox. cuadrado 20cm, extraplano, blanco mate y antical.
 Soporte teléfono regulable en altura.
 Mango ducha cuadrado.
 Grifería de latón blanco mate.
 Presión máximo 6 at. mínimo 1 at.
 Caudal medio 12 l/min.
 Distribuidor redondo de latón blanco mate.
 Flexo reforzado 1,5 m
 Cartucho monomando cerámico 35 mm.

Ref.: BDAR025-1BL

Monomando de lavabo.
 Cuerpo de grifería en Latón blanco mate.
 Cartucho cerámico Citec de 25 mm.
 Flexos 3/8.

Ref.: BDAR025-2BL

Monomando de bidé.
 Cuerpo de grifería en Latón blanco mate.
 Cartucho cerámico Citec de 25 mm.
 Flexos 3/8

Ref.: BDAR025-3BL

Monomando de lavabo alto.
 Cuerpo de grifería en Latón blanco mate.
 Cartucho cerámico de 25 mm.
 Flexos 3/8

ART NEGRO MATE

SERIE

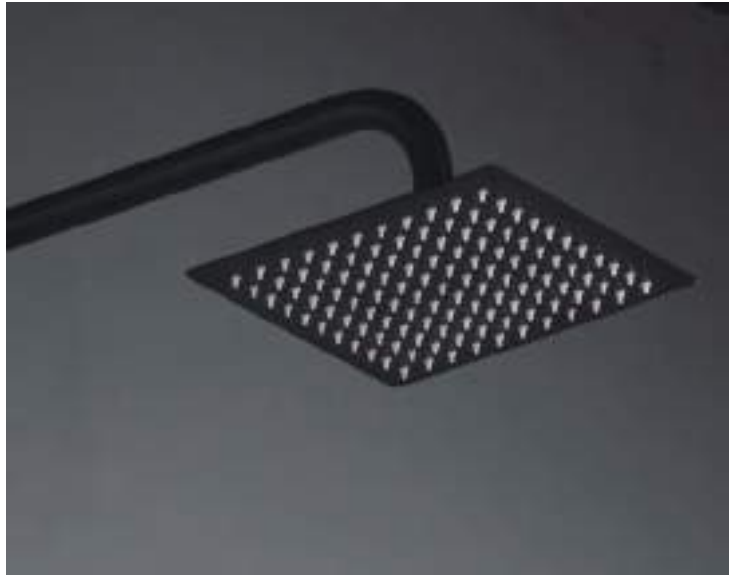





Ref.: BDAR025/NG

Barra de ducha extensible de acero inox. negro mate extensible 93,5/130cm.
 Rociador de acero inox. cuadrado 20cm, extraplano, negro mate y antical.
 Soporte teléfono regulable en altura.
 Mango ducha cuadrado.
 Grifería de latón negro mate.
 Presión máximo 6 at. mínimo 1 at.
 Caudal medio 12 l/min.
 Distribuidor redondo de latón negro mate.
 Flexo reforzado 1,5 m
 Cartucho monomando cerámico 35 mm.

Ref.: BDAR025-1NG

Monomando de lavabo.
 Cuerpo de grifería en Latón negro mate.
 Cartucho cerámico Citec de 25 mm.
 Flexos 3/8.

Ref.: BDAR025-2NG

Monomando de bidé.
 Cuerpo de grifería en Latón negro mate.
 Cartucho cerámico Citec de 25 mm.
 Flexos 3/8

Ref.: BDAR025-3NG

Monomando de lavabo alto.
 Cuerpo de grifería en Latón negro mate.
 Cartucho cerámico de 25 mm.
 Flexos 3/8



BREMEN

SERIE



De estructura moderna y voluminosa.

Un producto único, diseñado por nosotros en el que resalta la calidad y la funcionalidad.







Ref. : BDB006

Barra de ducha extensible de acero inox. extensible 87,5/130cm.
 Rociador de acero inox. cuadrado 20cm,extraplano,cromado y antical.
 Soporte teléfono regulable en altura.
 Mango ducha cuadrado.
 Grifería de latón cromado.
 Presión máximo 6 at. mínimo 1 at.
 Caudal medio 12 l/min.
 Distribuidor cuadrado de latón cromado integrado.
 Flexo reforzado 1,5 m
 Cartucho monomando cerámico 35 mm.



BREMEN

SERIE



Ref. : BDB006-1

Monomando de lavabo.
 Cuerpo de grifería en Latón cromado.
 Cartucho cerámico de 35 mm.
 Flexos 3/8.



Ref. : BDB006-2

Monomando de bidé.
 Cuerpo de grifería en Latón cromado.
 Cartucho cerámico de 35 mm.
 Flexos 3/8.





LIVERPOOL

SERIE



LA DUCHA, MÁS SENTIDO QUE NUNCA.

Cuando el sentido se transforma en algo esencial para tu vida, cuando sientes el estilo como algo propio y personal. Líneas estilizadas y únicas para tu hogar.







Barra de ducha extensible de acero inox. extensible 86/120 cm. Opción ducha.
 Barra de bañera extensible de acero inox. extensible 102-165 cm. Opción bañera.
 Rociador de acero inox. cuadrado 20cm,extraplano,cromado y antical.
 Soporte teléfono regulable en altura.
 Mango ducha cuadrado.
 Grifería de latón cromado.
 Presión máximo 6 at. mínimo 1 at.
 Caudal medio 12 l/min.
 Distribuidor cuadrado de latón cromado integrado.
 Flexo reforzado 1,5 m
 Cartucho monomando cerámico 35 mm.



Ref. : BDB007-B
 (opción bañera)

Ref. : BDB007
 (opción ducha)



LIVERPOOL

SERIE

Ref. : BDL007-1
 Monomando de lavabo.
 Cuerpo de grifería en Latón cromado.
 Cartucho cerámico de 35 mm.
 Flexos 3/8.

Ref. : BDL007-2
 Monomando de bide.
 Cuerpo de grifería en Laton cromado.
 Cartucho cerámico de 35 mm.
 Flexos 3/8.





SAONA

SERIE

El diseño y la tecnología aunados para dar sentido a un modelo exquisito, con unas formas únicas e irrepetibles que enamoran a simple vista.

SAONA

SERIE



EXCELENTE, PRÁCTICO Y ORIGINAL.





Ref.: BDO020

Barra de bañera extensible de acero inox. extensible 101/163,5 cm.
 Rociador de acero inox. cuadrado 20cm,extraplano,cromado y antical.
 Soporte teléfono regulable en altura.
 Mango ducha cuadrado.
 Grifería de latón cromado.
 Presión máximo 6 at. mínimo 1 at.
 Caudal medio 12 l/min.
 Distribuidor cuadrado de latón cromado integrado de 3 vías.
 Flexo reforzado 1,5 m
 Cartucho monomando cerámico 35 mm.



SISTEMA DE AHORRO ENERGÉTICO

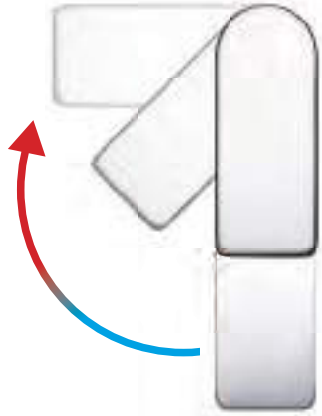

Ref. : BDO020-1
 Monomando de lavabo.
 Cuerpo de grifería en Latón cromado.
 Cartucho cerámico de 35 mm.
 Apertura en frío.
 Flexos 3/8.

Grifería con certificación ACS 15 YEARS

Ref. : BDO020-2
 Monomando de bidé.
 Cuerpo de grifería en Latón cromado.
 Cartucho cerámico de 35 mm.
 Apertura en frío.
 Flexos 3/8.

Grifería con certificación ACS 15 YEARS



BRISTOL

SERIE



Esencia y pureza se hacen realidad.



BRISTOL

SERIE





Ref. : BDB008

Barra de bañera extensible de acero inox. extensible 100/162 cm.
 Rociador de acero inox. cuadrado 20cm,extraplano,cromado y antical.
 Soporte teléfono regulable en altura.
 Mango ducha redondo.
 Grifería de latón cromado con caño de bañera plegable.
 Presión máximo 6 at. mínimo 1 at.
 Caudal medio 12 l/min.
 Distribuidor cuadrado de latón cromado integrado.
 Flexo reforzado 1,5 m
 Cartucho monomando cerámico 35 mm.



Ref. : BDB008-1
 Monomando de lavabo.
 Cuerpo de grifería en Latón cromado.
 Cartucho cerámico de 35 mm.
 Flexos 3/8.

Ref. : BDB008-2
 Monomando de bide.
 Cuerpo de grifería en Laton cromado.
 Cartucho cerámico de 35 mm.
 Flexos 3/8.



NANTES

SERIE



NANTES

SERIE



Producto desarrollado a partir de lingotes de latón fundidos.
Grifería caracterizada por su calidad y presencia.





Ref. : BDN009

Barra de ducha extensible de acero inox. extensible 93/135 cm.
 Rociador de acero inox. cuadrado 20cm,extraplano,cromado y antical.
 Soporte teléfono regulable en altura.
 Mango ducha cuadrado.
 Grifería de latón cromado.
 Presión máximo 6 at. mínimo 1 at.
 Caudal medio 12 l/min.
 Distribuidor cuadrado de latón cromado.
 Flexo reforzado 1,5 m
 Cartucho monomando cerámico 35 mm.



Grifería con certificación



Ref. : BDN009-1

Monomando de lavabo.
 Cuerpo de grifería en Latón cromado.
 Cartucho cerámico de 35 mm.
 Flexos 3/8.



Ref. : BDN009-2

Monomando de bide.
 Cuerpo de grifería en Laton cromado.
 Cartucho cerámico de 35 mm.
 Flexos 3/8.



Ref. : BDN009-3

Monomando de lavabo.
 Cuerpo de grifería en Latón cromado.
 Cartucho cerámico de 35 mm.
 Flexos 3/8.





FIYI

SERIE



La elegancia llevada a su máxima expresión. Integración en estado puro de todos sus elementos que hacen de esta serie una de las más atractivas de nuestra colección.



FIYI

SERIE



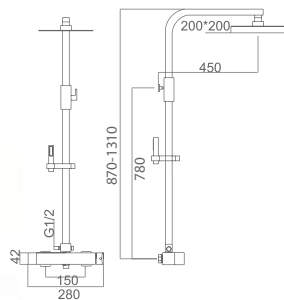

Ref.: BDF016

Barra de ducha extensible de acero inox. extensible 87/131 cm.
 Rociador de acero inox. cuadrado 20cm, extraplano, cromado y antical.
 Soporte teléfono regulable en altura.
 Mango ducha cuadrado.
 Grifería de latón cromado.
 Presión máximo 6 at. mínimo 1 at.
 Caudal medio 12 l/min.
 Distribuidor cuadrado de latón cromado integrado.
 Flexo reforzado 1,5 m
 Cartucho monomando cerámico 35 mm.

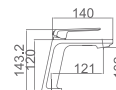

Ref.: BDF016-1

Monomando de lavabo.
 Cuerpo de grifería en Latón cromado.
 Cartucho cerámico Citec de 25 mm.
 Flexos 3/8

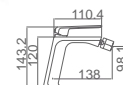

Ref.: BDF016-2

Monomando de bidé.
 Cuerpo de grifería en Latón cromado.
 Cartucho cerámico Citec de 25 mm.
 Flexos 3/8

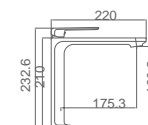

Monomando de lavabo alto.
 Cuerpo de grifería en Latón cromado.
 Cartucho cerámico Citec de 25 mm.
 Flexos 3/8

Ref.: BDF016-3



**Ref.: BDF016-5
 (+8 cm altura)**







Ref. : BDF016-4

Grifería baño/ducha latón cromado.
 Soporte para mango de ducha de ABS.
 Mango ducha cuadrado.
 Presión máximo 6 at. mínimo 1 at.
 Caudal medio 12 l/min.
 Flexo reforzado extensible 1,7/1,9
 Cartucho monomando cerámico de 25mm.

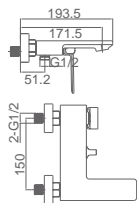

FIYI

SERIE



Ref.: **BDF016-4NG**

Grifería baño/ducha latón negro mate.
Soporte para mango de ducha de ABS.
Mango ducha cuadrado negro mate.
Presión máximo 6 at. mínimo 1 at.
Caudal medio 12 l/min.
Flexo reforzado PVC negro mate 1,7 m.
Cartucho monomando cerámico de 25mm.

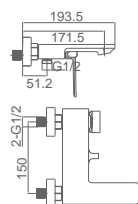





FIYI
NEGRO MATE
SERIE





FIYI NEGRO MATE

SERIE



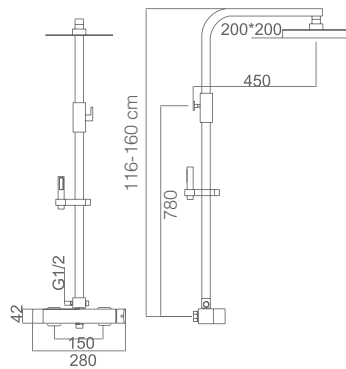

Ref. : BDF016-B/NG

Barra de bañera extensible de acero inox negro mate caño de bañera plegable .
Barra extensible 116/160 cm.
Rociador de acero inox. cuadrado 20cm, extraplano, negro y antical.
Soporte teléfono regulable en altura.
Mango ducha cuadrado negro mate.
Grifería de latón negro.
Presión máximo 6 at. mínimo 1 at.
Caudal medio 12 l/min.
Distribuidor cuadrado de latón negro integrado.
Flexo PVC negro mate 1,5 m
Cartucho monomando cerámico 35 mm.



Ref. : BDF016/NG

Barra de ducha extensible de acero inox negro mate extensible 87/131 cm.
 Rociador de acero inox. cuadrado 20cm, extraplano, negro y antical.
 Soporte teléfono regulable en altura.
 Mango ducha cuadrado negro mate.
 Grifería de latón negro.
 Presión máximo 6 at. mínimo 1 at.
 Caudal medio 12 l/min.
 Distribuidor cuadrado de latón negro integrado.
 Flexo reforzado PVC negro mate 1,5 m
 Cartucho monomando cerámico 35 mm.

Ref. : BDF016-1NG

Monomando de lavabo.
 Cuerpo de grifería en Latón negro.
 Cartucho cerámico Citec de 25 mm.
 Flexos 3/8

Ref. : BDF016-2NG

Monomando de bidé.
 Cuerpo de grifería en Latón negro.
 Cartucho cerámico Citec de 25 mm.
 Flexos 3/8

Ref. : BDF016-3NG

Monomando de lavabo alto.
 Cuerpo de grifería en Latón negro.
 Cartucho cerámico Citec de 25 mm.
 Flexos 3/8

Ref. : BDF016-5NG
 (+8 cm altura)





FIYI
BLANCO MATE

SERIE



FIYI
BLANCO MATE
SERIE



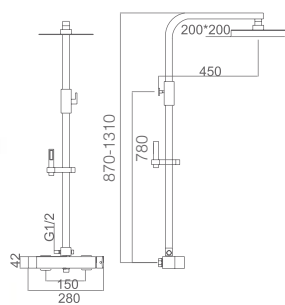

Ref. : BDF016/BL

Barra de ducha extensible de acero inox blanco mate extensible 87/131 cm.
 Rociador de acero inox. cuadrado 20cm, extraplano, blanco y antical.
 Soporte teléfono regulable en altura.
 Mango ducha cuadrado blanco mate.
 Grifería de latón blanco mate.
 Presión máximo 6 at. mínimo 1 at.
 Caudal medio 12 l/min.
 Distribuidor cuadrado de latón blanco integrado.
 Flexo reforzado PVC blanco mate 1,5 m
 Cartucho monomando cerámico 35 mm.

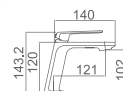

Ref. : BDF016-1BL

Monomando de lavabo.
 Cuerpo de grifería en Latón blanco mate.
 Cartucho cerámico Citec de 25 mm.
 Flexos 3/8

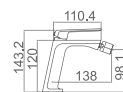

Ref. : BDF016-2BL

Monomando de bidé.
 Cuerpo de grifería en Latón blanco mate.
 Cartucho cerámico Citec de 25 mm.
 Flexos 3/8

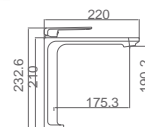

Monomando de lavabo alto.
 Cuerpo de grifería en Latón blanco mate.
 Cartucho cerámico Citec de 25 mm.
 Flexos 3/8

Ref. : BDF016-3BL



**Ref. : BDF016-5BL
 (+8 cm altura)**





BALI

SERIE



Conjunción de componentes cuadrados con líneas curvas que hacen de este producto uno de los más competitivos de nuestra marca.





BALI

SERIE



Ref: **BDI017**

Barra de ducha extensible de acero inox. extensible 94/130 cm.
 Rociador de acero inox. cuadrado 20cm, extraplano, cromado y antical.
 Soporte teléfono regulable en altura.
 Mango ducha cuadrado.
 Grifería de latón cromado.
 Presión máximo 6 at. mínimo 1 at.
 Caudal medio 12 l/min.
 Distribuidor redondo de latón cromado.
 Flexo reforzado 1,5 m
 Cartucho monomando cerámico 35 mm.



Test de la grifería aprobado



Ref: **BDI017-1**

Monomando de lavabo.
 Cuerpo de grifería en Latón cromado.
 Cartucho cerámico de 35 mm.
 Flexos 3/8.



Test de la grifería aprobado



Ref: **BDI017-2**

Monomando de bidé.
 Cuerpo de grifería en Latón cromado.
 Cartucho cerámico de 35 mm.
 Flexos 3/8.



Test de la grifería aprobado



Ref: **BDI017-3**

Monomando de lavabo alto.
 Cuerpo de grifería en Latón cromado.
 Cartucho cerámico de 35 mm.
 Flexos 3/8.



Test de la grifería aprobado





BALI

SERIE



Ref.: **BDI017-4**

Grifería baño/ducha de latón cromado.
 Soporte para mango de ducha en ABS.
 Mango ducha cuadrado.
 Presión máximo 6 at, mínimo 1 at.
 Caudal medio 12 l/min.
 Flexo reforzado extensible de 1,7/1,9 m
 Cartucho monomando cerámico 35mm.



Test de la grifería aprobado

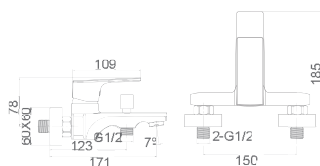

Ref.: **BDI017-5**

Grifería ducha de latón cromado.
 Soporte para mango de ducha en ABS.
 Mango ducha cuadrado.
 Presión máximo 6 at, mínimo 1 at.
 Caudal medio 12 l/min.
 Flexo reforzado extensible de 1,7/1,9 m
 Cartucho monomando cerámico 35mm.



Test de la grifería aprobado

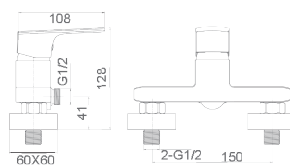



EUROPA

SERIE



Ref. : BDE011

(grifería no incluida)

Barra de ducha de acero inox. 97 cm.
Rociador de acero inox. redondo 20cm, extraplano, cromado y antical.
Soporte teléfono regulable en altura.
Mango ducha redondo.
Presión máximo 6 at. mínimo 1 at.
Caudal medio 12 l/min.
Distribuidor redondo de latón cromado.
Flexo reforzado 1,5 m
Flexo de conexión a grifería reforzado de 60 cm



MINSK

SERIE



Ref.: BDK010

(grifería no incluida)

Barra de ducha de acero inox. extensible 93/133 cm.
Rociador de acero inox. cuadrado 20cm, extraplano, cromado y antical.
Soporte teléfono regulable en altura.
Mango ducha cuadrado.
Presión máximo 6 at. mínimo 1 at.
Caudal medio 12 l/min.
Distribuidor cuadrado de latón cromado.
Flexo reforzado 1,5 m
Flexo de conexión a grifería reforzado de 60 cm







GRIFERÍA TERMOSTÁTICA

Griferías termostáticas de nueva generación con cartuchos contruídos de polímero que les confieren una especial resistencia al agua de tipo medio y duro



DUCHA TERMOSTÁTICA DE TECNOLOGÍA DE ÚLTIMA GENERACIÓN

IMEX

BATH EQUIPMENTS



RE-EVOLUCIÓN



Vídeo
spot



Vídeo
técnico
profesional



38°C

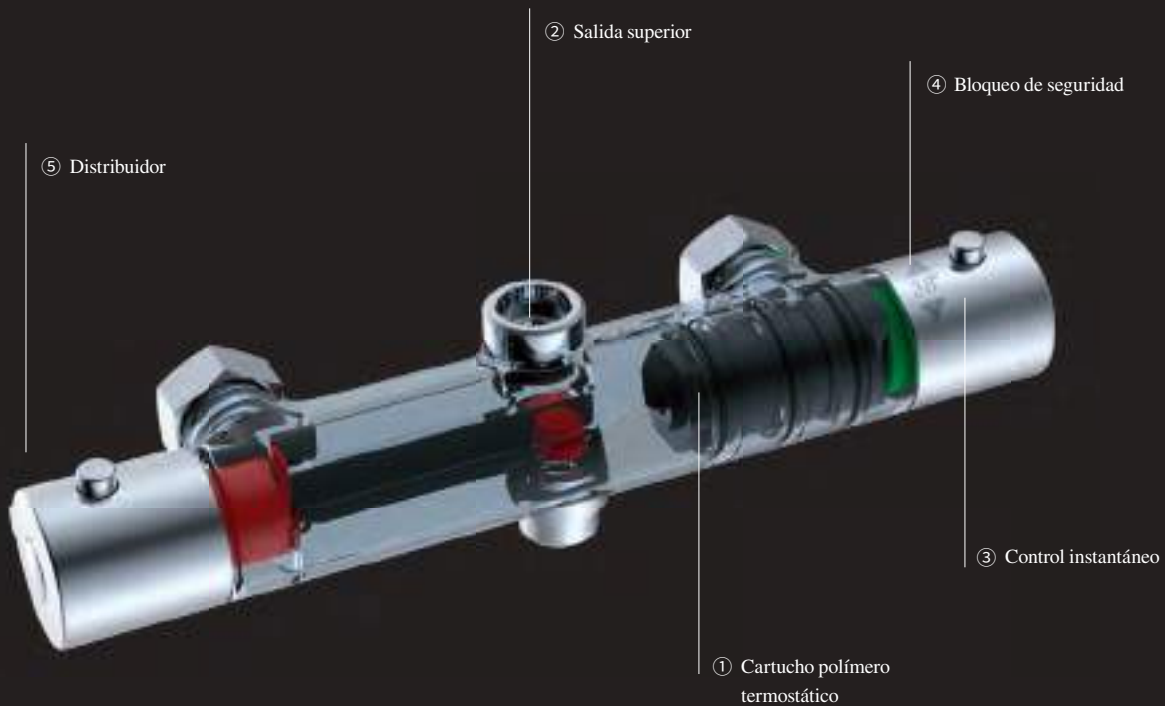

① Con el cartucho termoestático avanzado, el flujo de agua y la temperatura se pueden controlar de manera exacta y opcionalmente .

③ Controle exactamente el agua a la temperatura adecuada en un instante, para evitar el desperdicio de la temperatura o la presión del agua que cambia, proporcionando una sensación constante y cómoda durante el baño.

② Para mejorar la sensibilidad de los accesorios termoestáticos, la salida superior permanece constante y en la presión de agua baja y alta .

④ El bloqueo de seguridad debe ser presionado para obtener una temperatura >38°C, para evitar quemaduras.

⑤ El distribuidor integrado permite seleccionar la salida del agua en una dirección u otra.



NOVEDAD

GRIFERÍA TERMOSTÁTICA CON
TECNOLOGÍA DE ÚLTIMA GENERACIÓN
Sistema de giro y limpieza Turn Clean System
(Sistema patentado)

KENT

SERIE

Grifería termostática TURN CLEAN SYSTEM (patentado), equipada con tecnología de última generación.

- Sistema de seguridad anti-scalding.
- Funcionamiento óptimo en condiciones de baja presión.
- Limpieza de cartucho fácil, rápido y eficaz.

Vídeo spot



Vídeo técnico profesional



Ref. : BTK017

- Cartucho termostático **IMEX TURN CLEAN SYSTEM (patentado)**, con sensor Vernet.
- Rociador de acero inox. redondo Ø20 cm, extraplano, cromado y antical.
- Barra extensible de 94/130 cm
- Mango ducha redondo 3 posiciones.
- Grifería termostática de latón cromado con distribuidor incorporado.
- Presión máximo 8 at. mínimo 0,75 at.
- Caudal medio 12 l/min.
- Flexo reforzado 1,5 m.

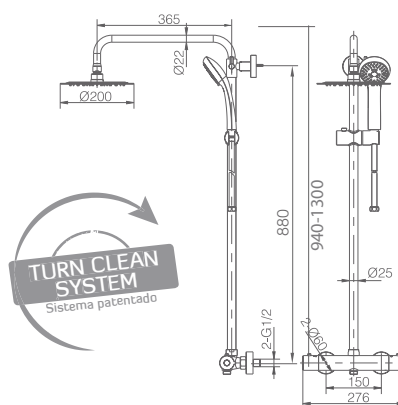

Grifería con certificación





CRETA

SERIE



Ref. : **BTC018**

Rociador de acero inox. redondo Ø20 cm, extraplano, cromado y antical.
Barra extensible de 88/130 cm
Mango ducha redondo 3 posiciones.
Grifería termostática de latón cromado con distribuidor incorporado.
Presión máximo 6 at. mínimo 1.5 at.
Caudal medio 12 l/min.
Flexo reforzado 1,5 m.
Cartucho termoestático Vernet.

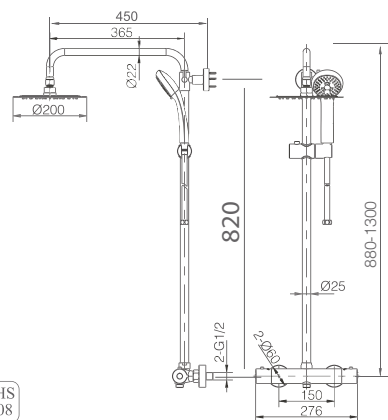

CRETA

SERIE

Ref. : **BTC018-5**

Mango ducha redondo 3 posiciones.
Grifería termostática ducha de latón cromado con distribuidor incorporado y cuerpo frío.
Soporte para mango de ducha ABS.
Presión máximo 6 at, mínimo 1.5 at.
Caudal medio 12 l/min.
Flexo reforzado extensible 1,7/1,9 m.
Cartucho termostático Vernet.



8 410201 123620

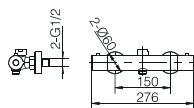





AMSTERDAM

SERIE

Ref. : **GTAM015**

Rociador de acero inox. redondo 25cm, extraplano, cromado y antical.
Barra extensible redonda de 88/124 cm
Mango ducha redondo 3 posiciones.
Grifería termostática de latón cromado con distribuidor incorporado.
Presión máximo 6 at. mínimo 1.5 at.
Caudal medio 12 l/min.
Flexo reforzado 1,5 m.
Cartucho termoestático Sedal.

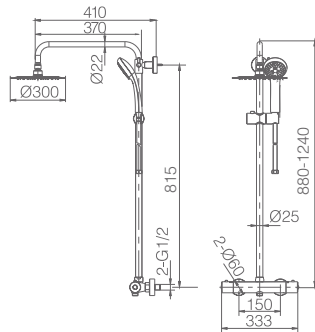



PRAGA

SERIE

Los detalles representan la perfección; sus líneas ovaladas le aportan gran belleza y distinción, siendo un modelo único y exclusivo.



Ref. : BTP012

Rociador de acero inox. ovalado 20x30 cm, extraplano, cromado y antical.
Barra extensible ovalada de 85/138 cm
Mango ducha redondo 3 posiciones.
Grifería termostática de latón cromado con distribuidor incorporado.
Presión máximo 6 at. mínimo 1.5 at.
Caudal medio 12 l/min.
Flexo PVC 1,5 m.
Cartucho termostático Sedal.

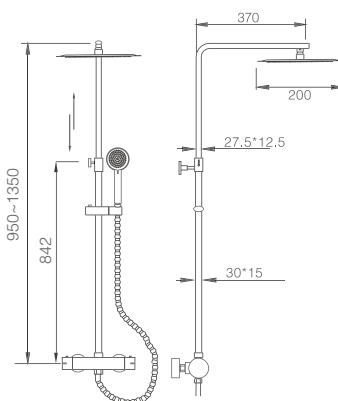



LONDRES

SERIE

Uno de los modelos más competitivos de nuestra marca, ya que su relación calidad precio es excelente.

Ref. : BTL011

Rociador de acero inox. redondo Ø20 cm, extraplano, cromado y antical.
Barra extensible de 94/130 cm
Mango ducha redondo 3 posiciones.
Grifería termostática de latón cromado con distribuidor incorporado.
Presión máximo 6 at. mínimo 1.5 at.
Caudal medio 12 l/min.
Flexo reforzado 1,5 m.
Cartucho termoestático Sedal.

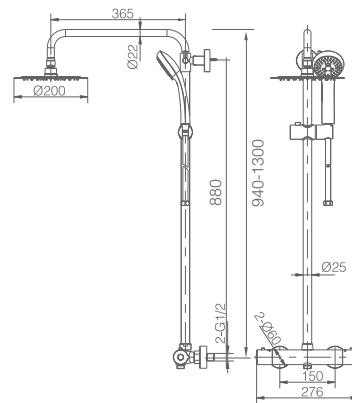

Grifería con
certificación







LONDRES NEGRO MATE

SERIE

Ref. : BTL011/NG

Rociador de acero inox redondo Ø20 cm, extraplano, negro mate y antical.
 Barra extensible de 94/130 cm
 Mango ducha redondo 3 posiciones.
 Grifería termostática de latón negro con distribuidor incorporado.
 Presión máximo 6 at. mínimo 1.5 at.
 Caudal medio 12 l/min.
 Flexo reforzado PVC negro mate 1,5 m.
 Cartucho termoestático Sedal.

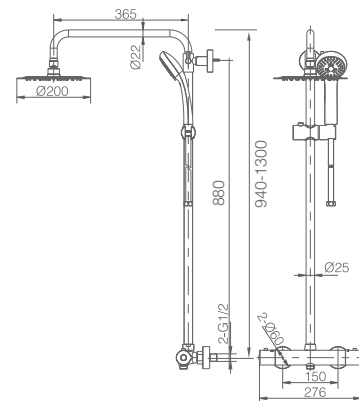

Grifería con
certificación



LONDRES

BLANCO MATE

SERIE



Ref. : BTL011/BL

Rociador de acero inox. redondo Ø20 cm, extraplano, blanco mate y antical.
 Barra extensible de 94/130 cm
 Mango ducha redondo 3 posiciones.
 Grifería termostática de latón blanco mate con distribuidor incorporado.
 Presión máximo 6 at. mínimo 1.5 at.
 Caudal medio 12 l/min.
 Flexo reforzado PVC 1,5 m.
 Cartucho termoestático Sedal.

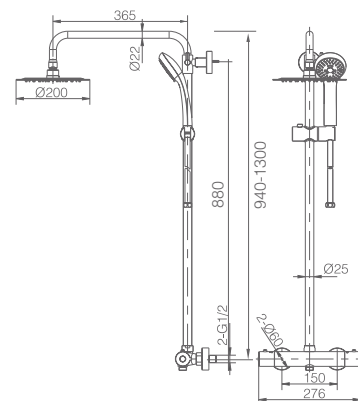

Grifería con certificación







BLED

SERIE Made in Europe

Uno de nuestros mejores productos. Durabilidad, resistencia y funcionamiento a muy baja presión hacen de este modelo uno de los más versátiles.

Ref. : BTB010

Rociador de acero inox. redondo Ø20 cm, extraplano, cromado y antical.
Barra extensible de 90/150 cm
Mango ducha redondo 3 posiciones.
Grifería termostática de latón cromado con distribuidor incorporado.
Presión máximo 6 at. mínimo 0,75 at.
Caudal medio 12 l/min.
Flexo reforzado 1,5 m.
Cartucho polímero Vernet.



Grifería con certificación

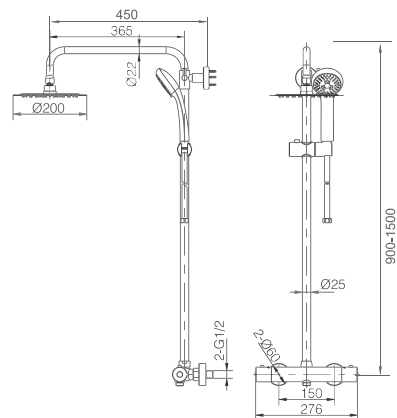



PROFESSIONAL
IMEX
DESIGN

VIGO

SERIE



Ref. : BTV013

Rociador de acero inox. cuadrado 20x20 cm, extraplano, cromado y antical.
Barra de ducha extensible de 87/130 cm
Mango ducha cuadrado.
Grifería termostática de latón cromado con distribuidor incorporado.
Presión máximo 6 at. mínimo 1,5 at.
Caudal medio 12 l/min.
Flexo reforzado 1,5 m.
Cartucho polímero Vernet.

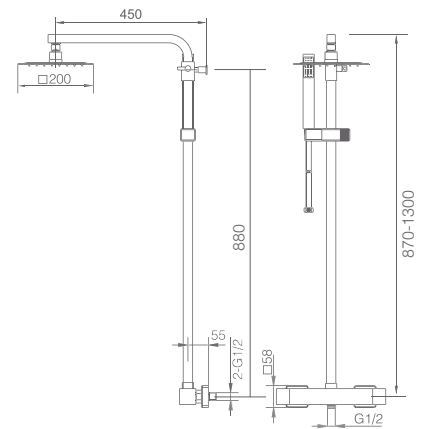

Grifería con
certificación



VIGO

NEGRO MATE

SERIE



Ref. : BTV013/NG

Rociador de acero inox. cuadrado 20x20 cm, extraplano, negro mate y antical.
Barra de ducha extensible de 87/130 cm
Mango ducha cuadrado.
Grifería termostática de latón negro mate con distribuidor incorporado.
Presión máximo 6 at. mínimo 1,5 at.
Caudal medio 12 l/min.
Flexo negro mate reforzado PVC 1,5 m.
Cartucho polímero Vernet.

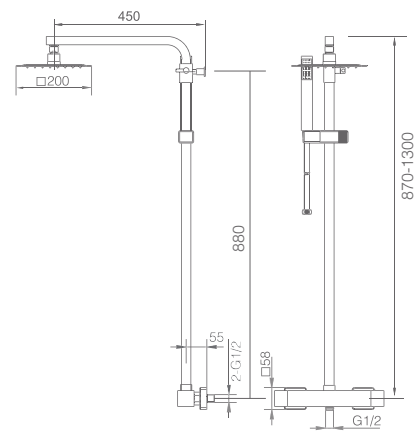

Grifería con certificación







SIDNEY

SERIE

Ref. : **BTS016**

Rociador de acero inox. ovalado 20x30 cm, extraplano, cromado y antical.

Barra de bañera extensible de 101/163,5 cm

Mango ducha redondo.

Grifería termostática de latón cromado con distribuidor incorporado y cascada.

Presión máximo 6 at. mínimo 2 at.

Caudal medio 12 l/min.

Flexo PVC 1,5 m.

Cartucho polímero Vernet.

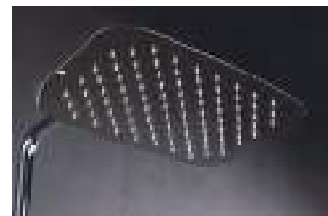
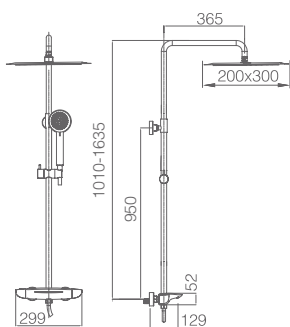

DUCHAS



EMPOTRADAS

La máxima expresión del diseño y las últimas novedades del mercado nos conducen a la integración de los productos en el baño.

IMEX se ha adaptado a los tiempos con la creación de diversas series empotradas.





ARUBA

SERIE

Líneas redondeadas y sutiles con un marcado carácter de diseño exclusivo y diferenciado.

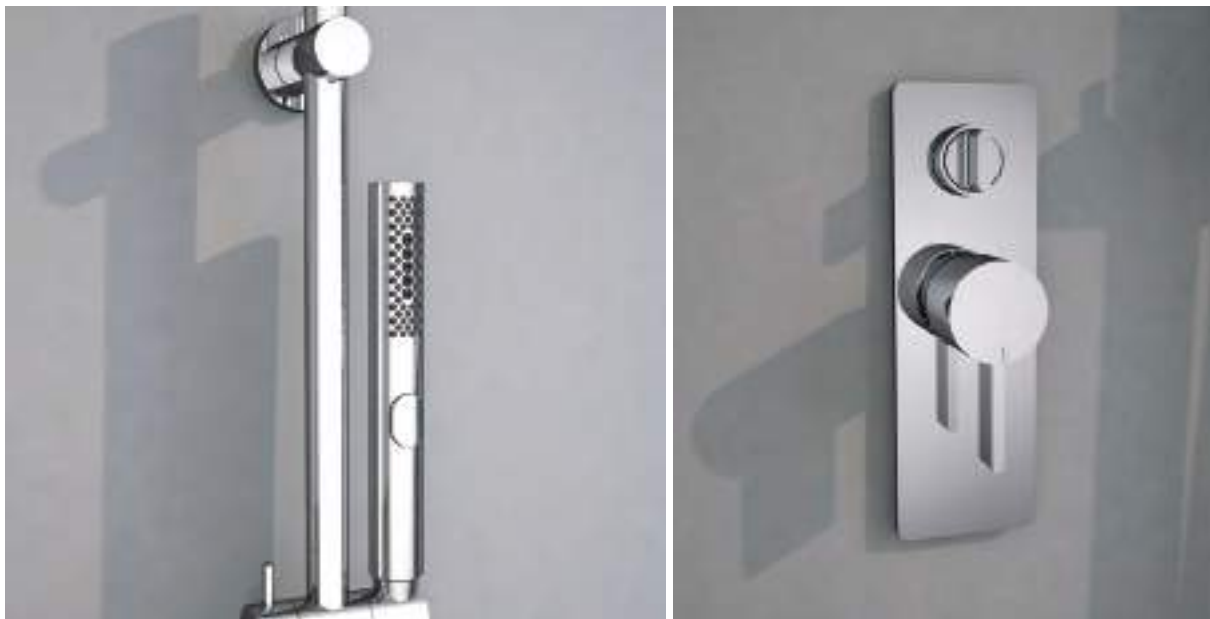

Ref. : GPA015

Rociador de acero inox. redondo 25cm, extraplano, cromado y antical.
Tubo salida pared redondo.
Barra de latón cromado con entrada de agua directa a pared y mango ducha redondo 2 posiciones.
Grifería monomando empotrada de dos vías de latón cromado.
Presión máximo 6 at,mínimo 1.5 at.
Caudal medio 12 l/min.
Flexo de PVC de 1.5 m.
Cartucho cerámico 35mm.

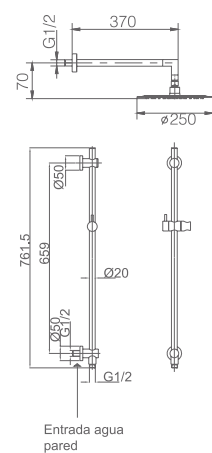



BAHAMAS

SERIE



Ref. : **GPH016/CR**

Barra de latón cromado y rociador integrado con distribuidor incorporado, dos vías, entrada de agua a pared.
Grifería monomando empotrada de una vía de latón cromado.
Presión máximo 6 at.mínimo 1.5 at.
Caudal medio 12 l/min.
Flexo de PVC de 1,5 m y mango de ducha.
Cartucho cerámico 35mm.

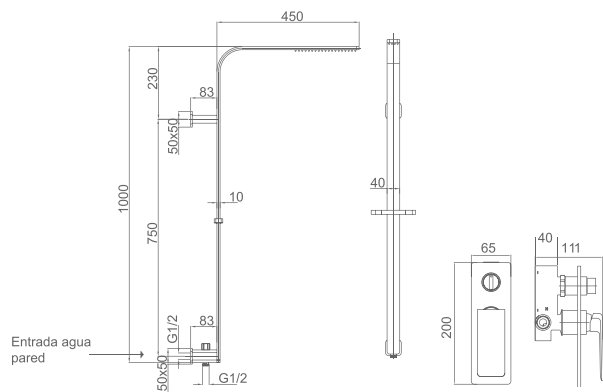

BAHAMAS BLANCO MATE

SERIE



Ref. : GPH016/BL

Barra de latón lacada blanco mate y rociador integrado con distribuidor incorporado, dos vías entrada de agua a pared.
Grifería monomando empotrada de una vía blanco mate.
Presión máximo 6 at.mínimo 1.5 at.
Caudal medio 12 l/min.
Flexo de PVC blanco mate de 1,5 m y mango de ducha blanco mate.
Cartucho cerámico 35mm.

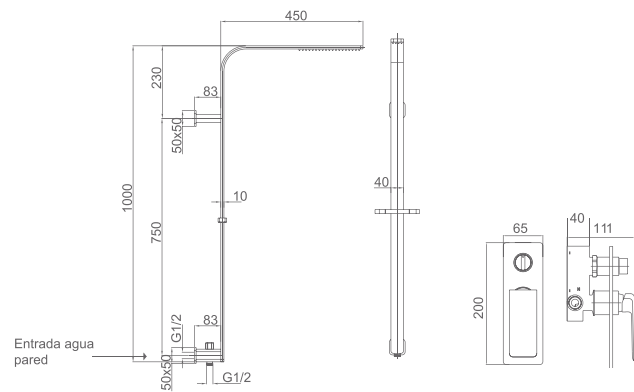





BAHAMAS

NEGRO MATE

SERIE



Ref. : GPH016/NG

Barra de latón lacada negro mate y rociador integrado con distribuidor incorporado, dos vías entrada de agua a pared.

Grifería monomando empotrada de una vía negro mate.

Presión máximo 6 at.mínimo 1.5 at.

Caudal medio 12 l/min.

Flexo de PVC negro mate de 1,5 m y mango de ducha negro mate.

Cartucho cerámico 35mm.

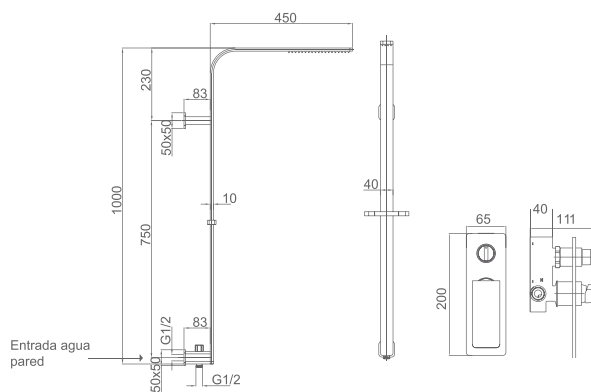

BORNEO

SERIE

Ref. : GPB022

Rociador cuadrado, acero inox. 25x25 cm, extraplano, cromado y antical.
Tubo salida pared cuadrado.
Barra de latón cromado con entrada de agua directa a pared y mango ducha cuadrado 3 posiciones.
Grifería monomando empotrada de dos vías de latón cromado.
Presión máximo 6 at, mínimo 1.5 at.
Caudal medio 12 l/min.
Flexo de PVC de 1,5 m.
Cartucho cerámico 35mm.

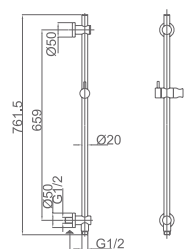
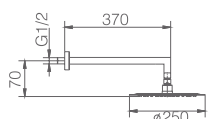

Entrada agua
pared







OSLO

SERIE



Líneas redondeadas y sutiles con un marcado carácter de diseño exclusivo y diferenciado.



OSLO

SERIE



Grifería con
certificación



MÓNACO

SERIE

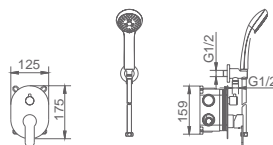
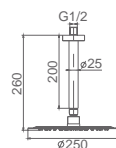

Ref. : GT003

Rociador de acero inox. redondo Ø25cm, extraplano, cromado y antical.
Tubo salida techo.
Mango ducha redondo.
Grifería monomando de latón cromado con caja de registro dos vías.
Presión máximo 6 at. mínimo 1 at.
Caudal medio 12 l/min.
Distribuidor redondo de latón cromado.
Flexo PVC 1,5 m y mango de ducha.
Cartucho monomando cerámico 35mm.
Soporte salida pared





DUBLÍN

SERIE



DUBLÍN

SERIE



BERLÍN

SERIE

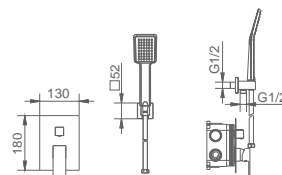
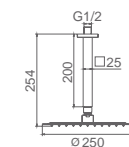

Ref. : GT006

Rociador de acero inox. cuadrado 25x25cm, extraplano, cromado y antical.
Tubo salida techo.
Mango ducha cuadrado.
Grifería monomando de latón cromado con caja de registro dos vías.
Presión máximo 6 at. mínimo 1 at.
Caudal medio 12 l/min.
Distribuidor cuadrado de latón cromado.
Flexo PVC 1,5 m y mango de ducha.
Cartucho monomando cerámico 35mm
Soporte salida pared





DUBLÍN NEGRO MATE

SERIE

Ref. : GPE006/NG

Rociador de acero inox. cuadrado 25x25cm, extraplano, negro mate y antical.
Tubo salida pared.
Mango ducha cuadrado.
Grifería monomando de latón negro con caja de registro dos vías.
Presión máximo 6 at. mínimo 1 at.
Caudal medio 12 l/min.
Distribuidor cuadrado de latón negro.
Flexo PVC negro mate 1,5 m.
Cartucho monomando cerámico 35mm.
Soporte salida pared negro.



Grifería con
certificación

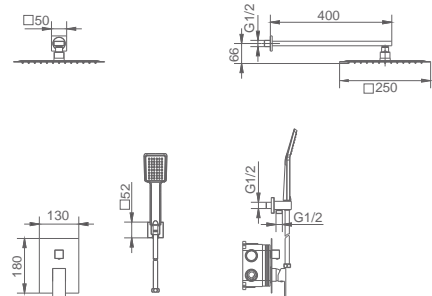
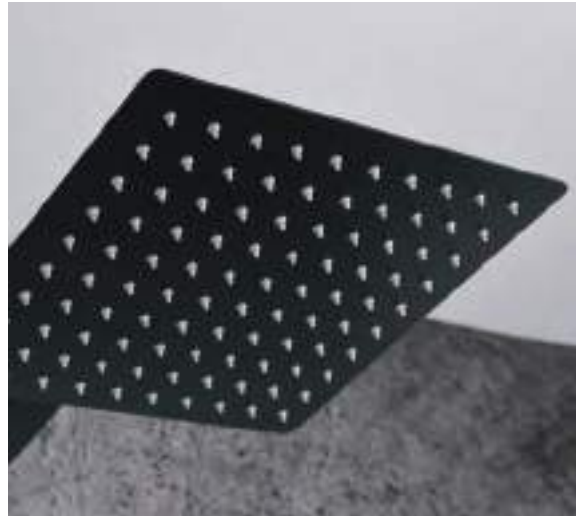



DUBLÍN
BLANCO MATE
SERIE



Ref. : GPE006/BL

Rociador de acero inox. cuadrado 25x25cm, extraplano, blanco mate y antical.
 Tubo salida pared.
 Mango ducha cuadrado.
 Grifería monomando de latón blanco con caja de registro dos vías.
 Presión máximo 6 at. mínimo 1 at.
 Caudal medio 12 l/min.
 Distribuidor cuadrado de latón blanco.
 Flexo PVC blanco mate 1,5 m.
 Cartucho monomando cerámico 35mm.
 Soporte salida pared blanco.

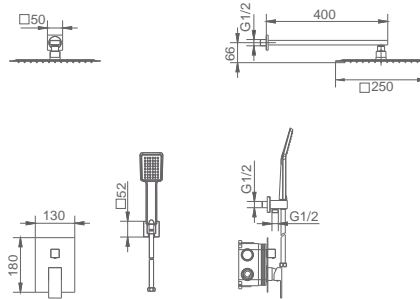

Grifería con certificación

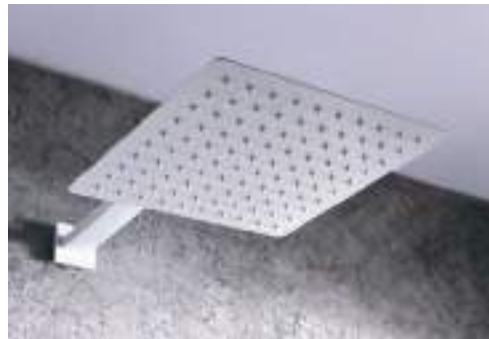





VOLGA

SERIE

Ref. : **GET015** (Encastrado a techo)

Rociador de acero inox. Cuadrado 40X40cm,extraplano,cromado y antical.
Mango ducha cuadrado.
Grifería monomando de latón cromado dos vías con caja de registro.
Presión máximo 6 at,mínimo 1 at.
Caudal medio 12 l/min.
Distribuidor cuadrado de latón cromado.
Flexo PVC 1,5 m.
Cartucho monomando cerámico 35mm.
Incluye premarco.
Soporte mango ducha salida pared

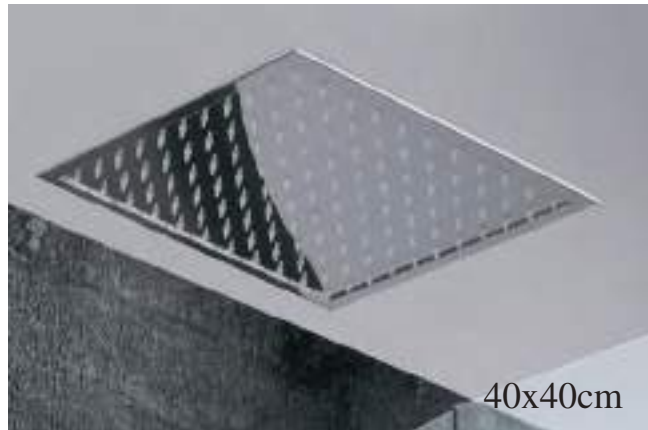

GALES

SERIE

Ref. : **GTG008** (Encastrado a techo)

Rociador de acero inox. Cuadrado 30X30cm,extraplano,cromado y antical.
Mango ducha cuadrado.
Grifería monomando de latón cromado dos vías con caja de registro.
Presión máximo 6 at,mínimo 1 at.
Caudal medio 12 l/min.
Distribuidor cuadrado de latón cromado.
Flexo PVC 1,5 m.
Cartucho monomando cerámico 35mm.
Incluye premarco.
Soporte mango ducha salida pared

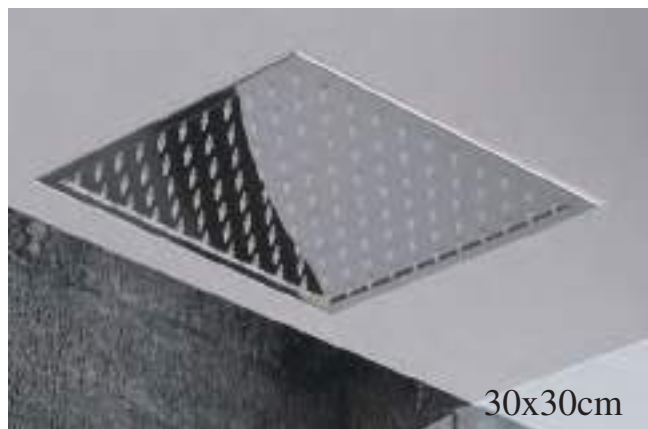

SUMATRA

SERIE

Conjunto de ducha de nueva creación. Gracias a su espectacular rociador de grandes dimensiones y diversas funciones capaces de aportar relax y confort excepcionales.



Rociador de acero inox. rectangular 48X59cm, extraplano, cromado y antical con tres salidas de agua opcionales.
 Mango ducha cuadrado.
 Grifería monomando de latón cromado 4 vías con caja de registro.
 Presión máximo 6 at. mínimo 3 at.
 Caudal medio 12 l/min.
 Distribuidor cuadrado de latón cromado.
 Flexo PVC 1,5 m.
 Cartucho monomando cerámico 35mm.
 Soporte mango ducha salida a pared.
 Incluye accesorios de montaje para instalación a techo.

Ref. : **GTS019**
SIN PREMARCO

Ref. : **GTS019/P**
CON PREMARCO (recomendado)

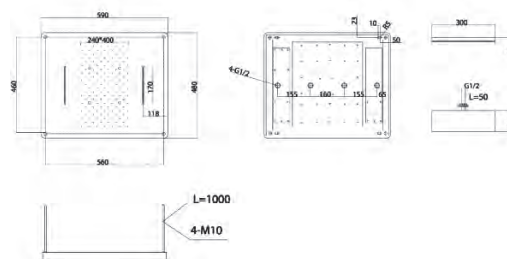







RODAS

SERIE

Conjunto de ducha de nueva creación. Gracias a su espectacular rociador de grandes dimensiones y diversas funciones capaces de aportar relax y confort excepcionales.

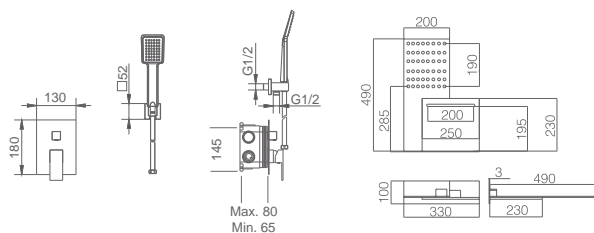
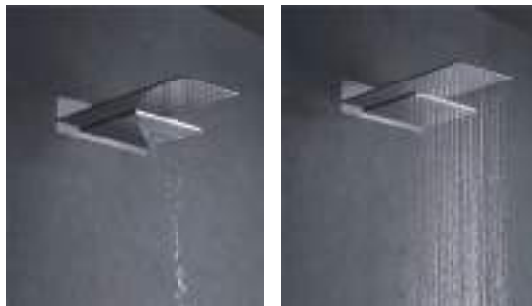

Vídeo spot



Vídeo técnico profesional



Ref. : GTR049

Rociador de acero inox. rectangular 48x33,5 cm, extraplano, cromado y antical con dos salidas de agua opcionales. Efecto lluvia y cascada. Mango ducha cuadrado.

Grifería termostática de latón cromado 3 vías con caja de registro. Presión máximo 6 at. mínimo 3 at.

Caudal medio 12 l/min.

Distribuidor cuadrado de latón cromado.

Flexo PVC 1,5 m y mango de ducha.

Cartucho termostático TURN CLEAN SYSTEM autolimpiante.

SopORTE mango ducha salida a pared.



RODAS

NEGRO MATE

SERIE

Conjunto de ducha de nueva creación. Gracias a su espectacular rociador de grandes dimensiones y diversas funciones capaces de aportar relax y confort excepcionales.

Ref. : **GTR049/NG**

Rociador de acero inox. rectangular 48x33,5 cm, extraplano, negro mate y antical con dos salidas de agua opcionales. Efecto lluvia y cascada. Mango ducha cuadrado.
Grifería termostática de latón negro mate 3 vías con caja de registro.
Presión máximo 6 at. mínimo 3 at.
Caudal medio 12 l/min.
Distribuidor cuadrado de latón negro mate.
Flexo PVC negro mate 1,5 m.
Cartucho termostático TURN CLEAN SYSTEM autolimpiable.
Soporte mango ducha salida a pared.

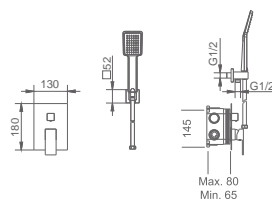
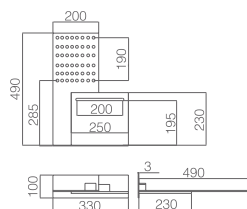

Vídeo
spot



Vídeo
técnico
profesional







MÁLAGA

SERIE

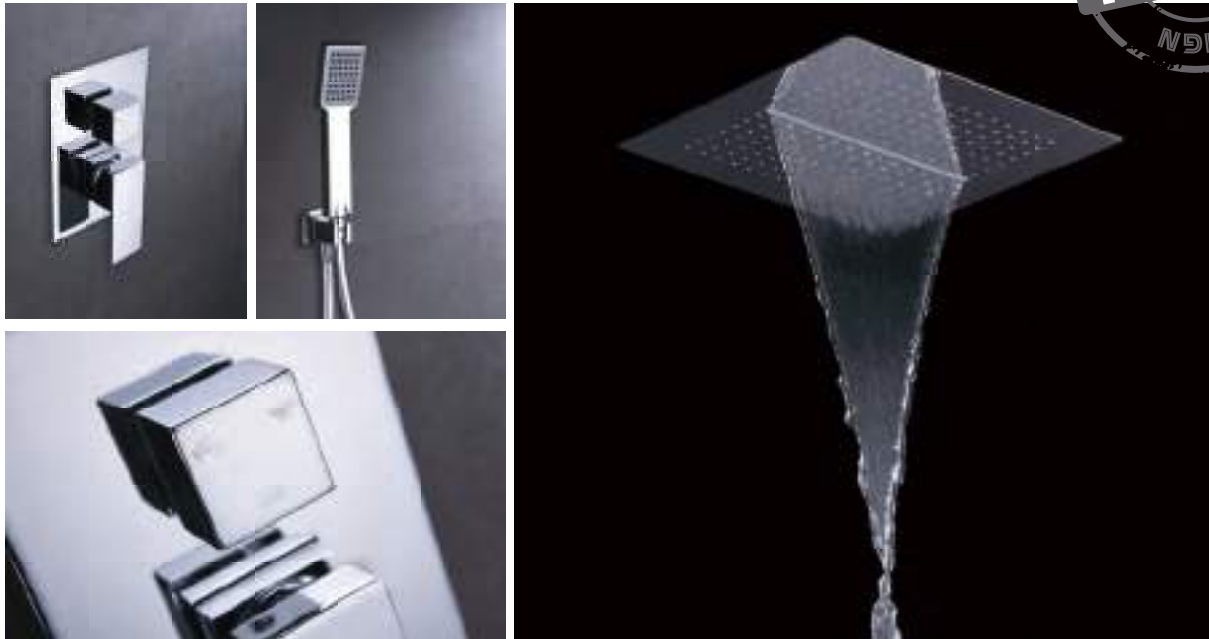

Ref. : GTS020 Incluye premarco a techo

Rociador de acero inox. cuadrado 40X40cm, extraplano, cromado y antical con dos salidas de agua opcionales.

Mango ducha cuadrado.

Grifería monomando de latón cromado 3 vías con caja de registro.

Presión máximo 6 at. mínimo 3 at.

Caudal medio 12 l/min.

Distribuidor cuadrado de latón cromado.

Flexo PVC 1,5 m.

Cartucho monomando cerámico 35mm.

SopORTE mango ducha salida a pared.

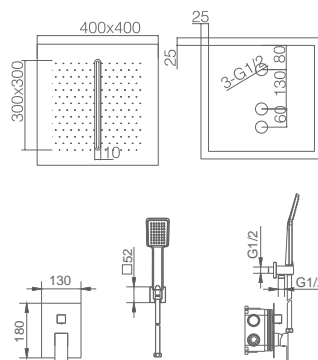

FORMENTERA

SERIE

Detalles que representan la perfección, modelo diseñado para aportar un máximo confort y elegancia, creando un espacio en el baño único e irrepetible.



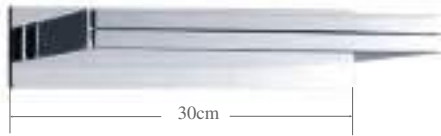

Ref. :GPE008

Rociador cascada 30 cm, cromado, acero S304.
Mango ducha Cuadrado.
Grifería monomando de latón cromado de 3 vías.
Presión máximo 6 at, mínimo 4 at.
Caudal medio 12 l/min.
Distribuidor Cuadrado de latón cromado.
Flexo PVC 1.5 m.
Cartucho monomando cerámico de 35mm.
Tres Jet Latón cromado y antical.
Soporte mango ducha salida a pared.



JAVA

SERIE

Conjunto de baño empotrado, máxima expresión del relax en su estado pleno, gracias a su cascada de grandes dimensiones. Es un producto polivalente con tres funciones de uso: llenado de bañera, rociador superior y mango de ducha.

Ref. :GPV017

Rociador Cuadrado 25x25 cm cromado y antical.
Mango ducha Cuadrado 3 posiciones.
Grifería monomando de latón cromado 3 vías.
Caño de bañera cascada de 30 cm, acero S304.
Presión máximo 6 at. mínimo 3 at.
Caudal medio 12 l/min.
Distribuidor Cuadrado de latón cromado.
Flexo PVC 1,5 m.
Cartucho monomando cerámico 35mm.
Soporte mango ducha salida a pared.
Tubo pared cuadrado

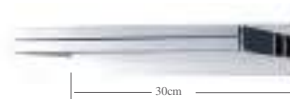
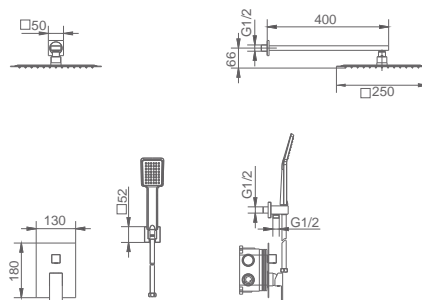





ITALIA

SERIE



ITALIA

SERIE

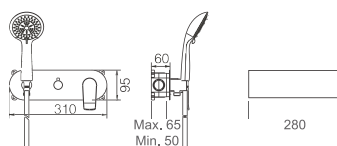
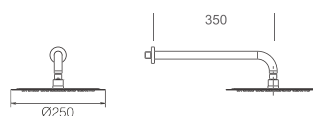
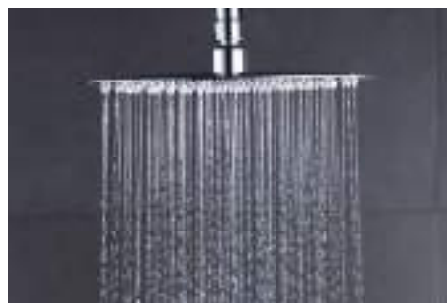

Ref. : GPI013

Rociador de acero inox. redondo Ø25cm, extraplano, cromado y antical.

Tubo salida pared de latón.

Mango ducha redondo.

Grifería monomando de latón cromado 2 vías con caja de registro.

Presión máximo 6 at. mínimo 1 at.

Caudal medio 12 l/min.

Distribuidor redondo de latón cromado.

Flexo PVC 1,5 m.

Cartucho monomando cerámico 35mm.



Grifería con certificación



FRANCIA

SERIE

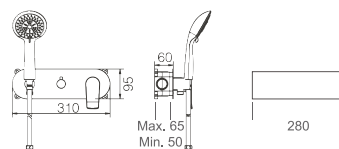

Ref. : GTF014

Rociador de acero inox. redondo Ø25cm, extraplano, cromado y antical.
Tubo salida techo de latón.
Mango ducha redondo.
Grifería monomando de latón cromado 2 vías con caja de registro.
Presión máximo 6 at. mínimo 1 at.
Caudal medio 12 l/min.
Distribuidor redondo de latón cromado.
Flexo PVC 1,5 m.
Cartucho monomando cerámico 35mm.



Grifería con certificación





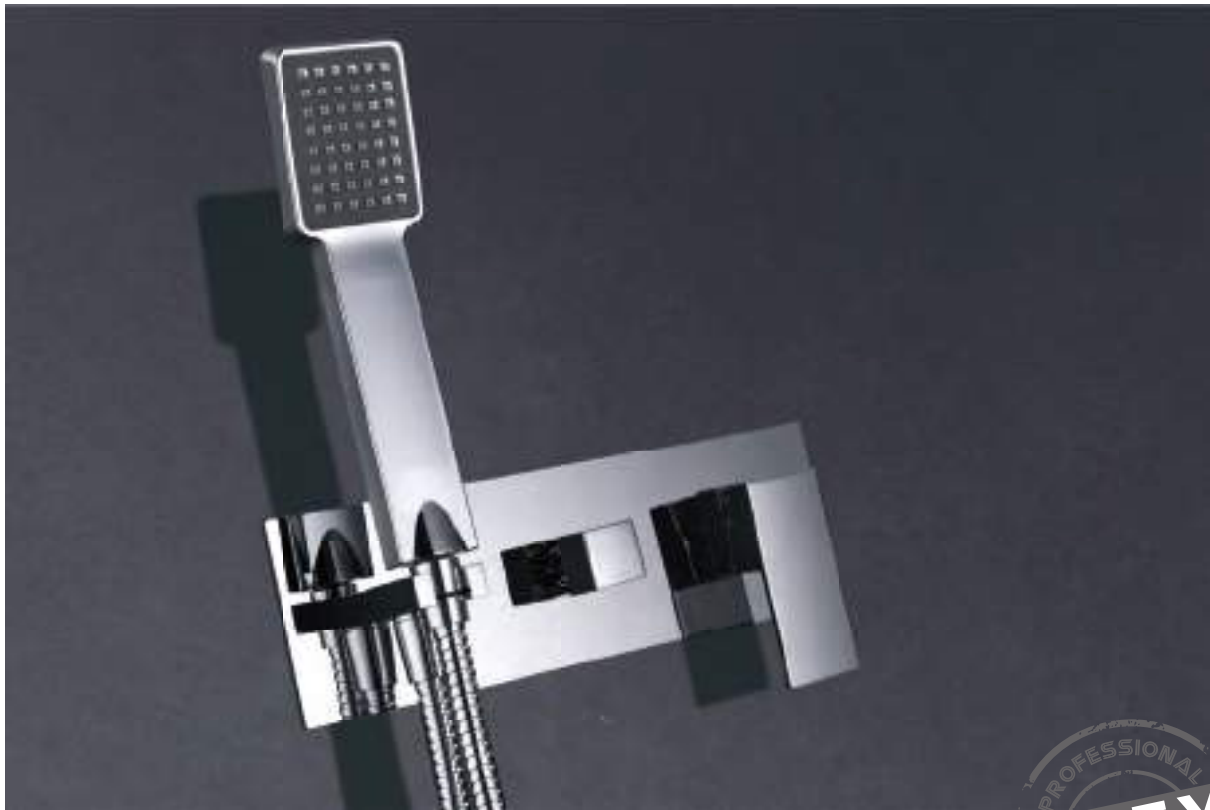

Empotrada lineal que se integra a la perfección en cualquier ambiente.



NORUEGA

SERIE

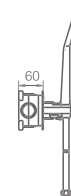
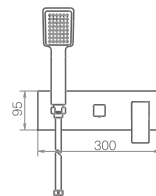

Ref. : GPN011

Rociador de acero inox. Cuadrado
25X25cm,extraplano,cromado y antical.
Tubo salida pared de latón.
Mango ducha cuadrado.
Grifería monomando de latón cromado 2 vías, caja de registro.
Presión máximo 6 at.mínimo 1 at.
Caudal medio 12 l/min.
Distribuidor cuadrado de latón cromado.
Flexo PVC 1,5 m.
Cartucho monomando cerámico 35mm.



Grifería con
certificación



FINLANDIA

SERIE

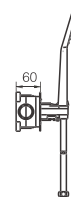
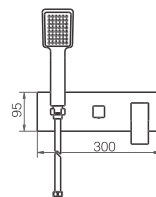

Ref. : GTF012

Rociador de acero inox. Cuadrado
25X25cm,extraplano,cromado y antical.
Tubo salida techo de latón.
Mango ducha cuadrado.
Grifería monomando de latón cromado 2 vías, caja de registro.
Presión máxima 6 at.mínimo 1 at.
Caudal medio 12 l/min.
Distribuidor cuadrado de latón cromado.
Flexo PVC 1,5 m.
Cartucho monomando cerámico 35mm.



Grifería con
certificación







Termostática empotrada de líneas cuadradas de alta precisión, la excelencia en estado puro, se la otorgan unas líneas minimalistas.

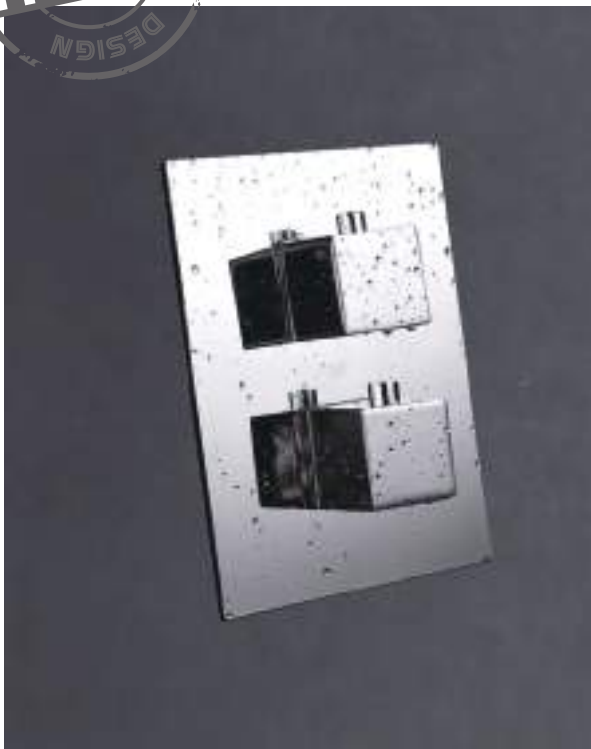

ONS

SERIE

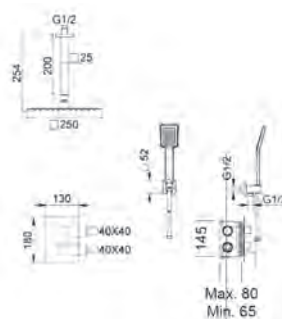

Ref. : GPC010

Rociador de acero inox. Cuadrado 25X25cm, extraplano, cromado y antical.
Tubo salida techo latón.
Mango ducha cuadrado.
Grifería termostática de latón cromado, 2 vías con caja de registro.
Presión máximo 6 at.mínimo 1 at.
Caudal medio 12 l/min.
Distribuidor cuadrado de latón cromado.
Flexo reforzado PVC 1,5 m
Cartucho termostático VERNET.
Soporte mango ducha con salida agua pared.



Grifería con certificación



CIES

SERIE

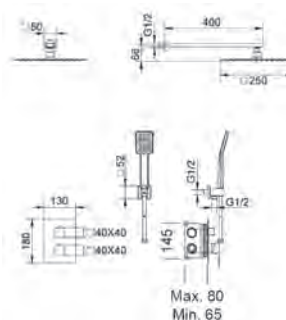

Ref. : GPC009

Rociador de acero inox. Cuadrado 25X25cm, extraplano, cromado y antical.

Tubo salida pared de latón.

Mango ducha cuadrado.

Grifería termostática de latón cromado, 2 vías con caja de registro.

Presión máximo 6 at.mínimo 1 at.

Caudal medio 12 l/min.

Distribuidor cuadrado de latón cromado.

Flexo reforzado PVC 1,5 m

Cartucho termostático VERNET

Soporte mango ducha con salida agua pared.



Grifería con certificación





Ref. : GPC009/NG

Rociador de acero inox Cuadrado 25X25cm, extraplano, negro mate y antical.

Tubo salida pared de latón.

Mango ducha cuadrado.

Grifería termostática de latón negro, 2 vías con caja de registro.

Presión máximo 6 at.mínimo 1 at.

Caudal medio 12 l/min.

Distribuidor cuadrado de latón negro.

Flexo reforzado PVC negro mate 1,5 m

Cartucho termostático VERNET

Soporte mango ducha con salida agua pared negro.

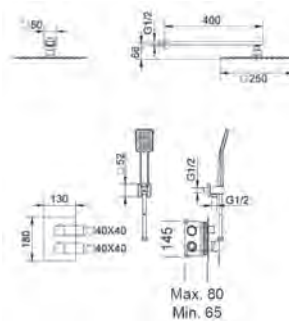

NF 77	EN 1111	ASSE 1016	ASSE 1070	ASSE 1017	NHS D08
----------	------------	--------------	--------------	--------------	------------

CIES
NEGRO MATE

SERIE



Grifería con
certificación





Ref. : GPC009/BL

Rociador de acero inox. Cuadrado 25X25cm, extraplano, blanco mate y anticál.

Tubo salida pared de latón.

Mango ducha cuadrado.

Grifería termostática de latón blanco, 2 vías con caja de registro.

Presión máximo 6 at.mínimo 1 at.

Caudal medio 12 l/min.

Distribuidor cuadrado de latón blanco.

Flexo reforzado PVC blanco mate 1,5 m

Cartucho termostático VERNET

Soporte mango ducha con salida agua pared blanco.

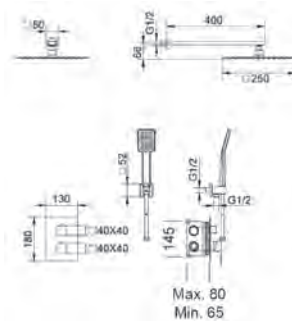

NF 77	EN 1111	ASSE 1016	ASSE 1070	ASSE 1017	NHS D08
----------	------------	--------------	--------------	--------------	------------

CIES

BLANCO MATE

SERIE



Grifería con certificación



MILOS SERIES

SERIE





THALOS SERIES

SERIE

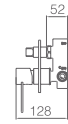
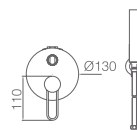
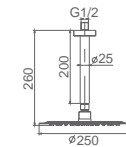

Ref. : GPT030

Rociador de acero inox. redondo 250cm, extraplano, cromado y antical.
Tubo salida techo latón cromado.
Mango ducha redondo.
Grifería monomando de latón cromado, 2 vías.
Presión máximo 6 at.mínimo 1 at.
Caudal medio 12 l/min.
Distribuidor redondo de latón cromado.
Flexo reforzado PVC 1,5 m
Cartucho monomando 35mm.
Soporte mango ducha con salida agua pared.



MILOS SERIES

SERIE

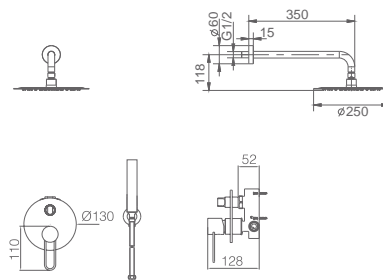

Ref. : GPM029

Rociador de acero inox. redondo 250cm, extraplano, cromado y antical.
Tubo salida pared latón cromado.
Mango ducha redondo.
Grifería monomando de latón cromado, 2 vías.
Presión máximo 6 at.mínimo 1 at.
Caudal medio 12 l/min.
Distribuidor redondo de latón cromado.
Flexo reforzado PVC 1,5 m
Cartucho monomando 35mm.
Soporte mango ducha con salida agua pared.





Ref. : GPM029/NG

Rociador de acero inox. redondo 250cm, extraplano, negro mate y antical.
 Tubo salida pared latón negro mate.
 Mango ducha redondo.
 Grifería monomando de latón negro mate, 2 vías.
 Presión máximo 6 at.mínimo 1 at.
 Caudal medio 12 l/min.
 Distribuidor redondo de latón negro mate.
 Flexo reforzado PVC 1,5 m
 Cartucho monomando 35mm.
 Soporte mango ducha con salida agua pared.

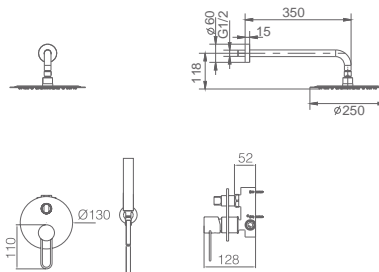

Grifería con certificación





Ref. : GPM029/BL

Rociador de acero inox. redondo 250cm, extraplano, blanco mate y antical.
 Tubo salida pared latón blanco mate.
 Mango ducha redondo.
 Grifería monomando de latón blanco mate, 2 vías.
 Presión máximo 6 at.mínimo 1 at.
 Caudal medio 12 l/min.
 Distribuidor redondo de latón blanco mate.
 Flexo reforzado PVC 1,5 m
 Cartucho monomando 35mm.
 Soporte mango ducha con salida agua pared.

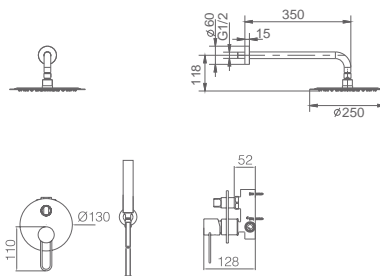

Grifería con certificación



MILOS SERIES

NEGRO ORO ROSA



SERIE





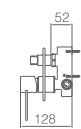
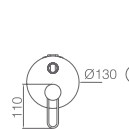
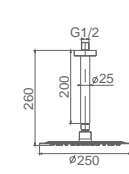

THALOS SERIES

SERIE

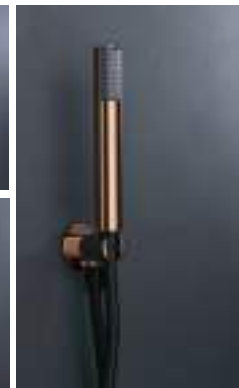

Ref. : GPT030/NOR

Rociador de acero inox. redondo 25Øcm, extraplano, oro rosa y antical.
Tubo salida techo latón negro mate, oro rosa.
Mango ducha redondo.
Grifería monomando de latón negro, oro rosa, 2 vías.
Presión máximo 6 at.mínimo 1 at.
Caudal medio 12 l/min.
Distribuidor redondo de latón negro, oro rosa.
Flexo reforzado PVC 1,5 m
Cartucho monomando 35mm.
Soporte mango ducha con salida agua pared.



MILOS SERIES

SERIE

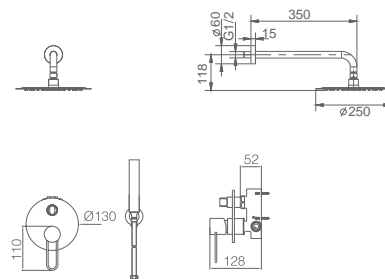

Ref. : GPM029/NOR

Rociador de acero inox. redondo 25Øcm, extraplano, oro rosa y antical.

Tubo salida pared latón negro mate, oro rosa.

Mango ducha redondo.

Grifería monomando de latón negro, oro rosa, 2 vías.

Presión máximo 6 at.mínimo 1 at.

Caudal medio 12 l/min.

Distribuidor redondo de latón negro, oro rosa.

Flexo reforzado PVC 1,5 m

Cartucho monomando 35mm.

Soporte mango ducha con salida agua pared.





ACERO
S 316
INOX

MOSCU

SERIE

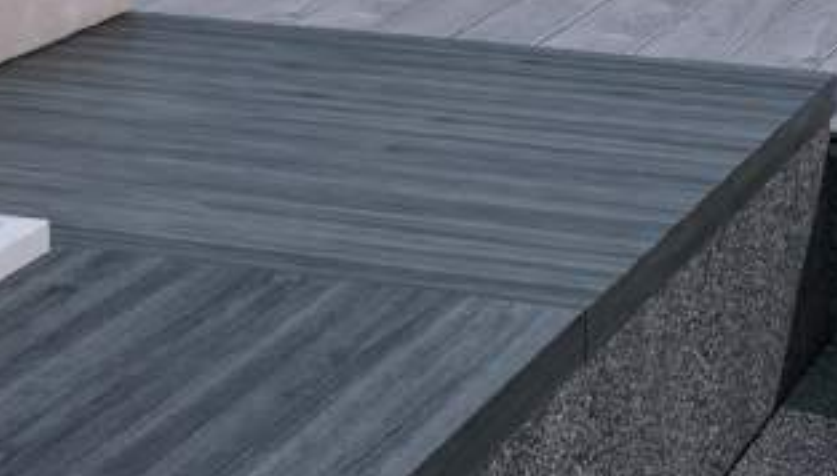



ACERO
S 316
INOX

MOSCU

SERIE





10 AÑOS
GARANTÍA
ANTICORROSIÓN
ACERO INOX. S316

Válido tanto para interior como exterior. Alta resistencia

MOSCU

SERIE

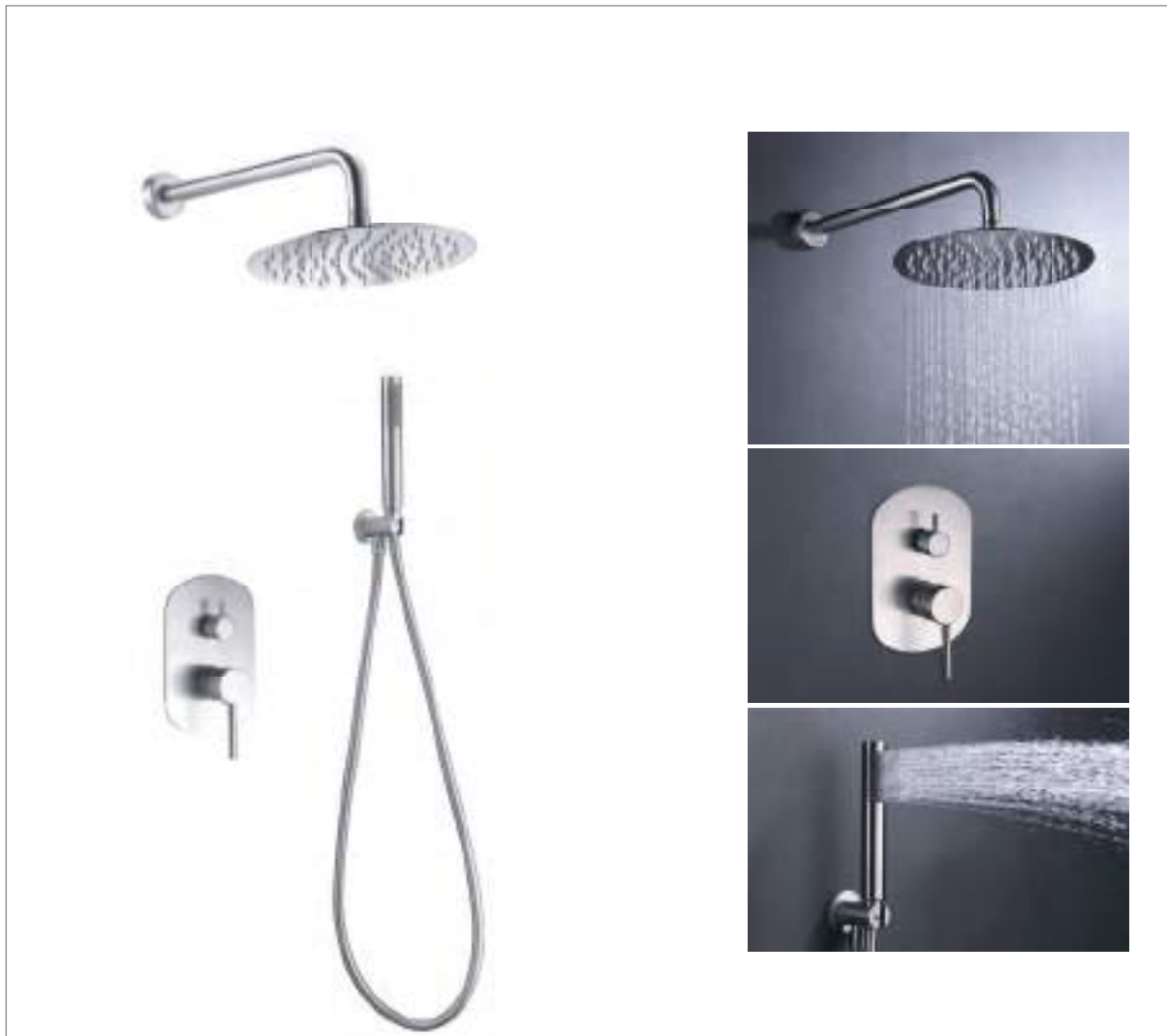

Ref. : GPK034

Rociador de acero inox. Aisi 316, máxima calidad anticorrosión y alta resistencia. Ø 25
Tubo de acero inox. Aisi 316, máxima calidad anticorrosión y alta resistencia salida pared.
Mango ducha redondo Aisi 316, máxima calidad anticorrosión y alta resistencia.
Grifería monomando, Aisi 316, máxima calidad anticorrosión y alta resistencia, 2 vías con caja de registro.
Presión máximo 6 at.mínimo 1 at.
Caudal medio 12 l/min.
Distribuidor cuadrado de acero Aisi 316.
Flexo reforzado PVC 1,5 m
Cartucho monomando 35mm.
Soporte mango ducha con salida agua pared Aisi 316, máxima calidad anticorrosión y alta resistencia

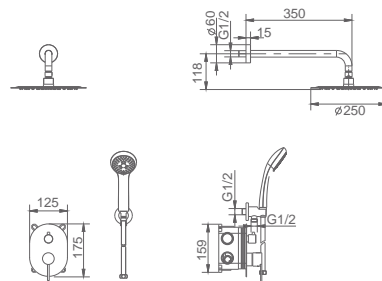

Grifería con certificación





MADEIRA

SERIE



MADEIRA

SERIE



Vídeo spot



Vídeo técnico profesional



Ref. : **GTM021**

Rociador de acero inox. Cuadrado 25X25cm, extraplano, cromado y antical.

Tubo salida pared latón cromado.

Mango ducha cuadrado.

Grifería termostática de latón cromado, 2 vías con pulsador y caja de registro.

Presión máximo 6 at.mínimo 1 at.

Caudal medio 12 l/min.

Distribuidor de pulsador de latón cromado.

Flexo reforzado PVC 1,5 m

Cartucho termostático autolimpiable TURN CLEAN SYSTEM.

Soporte mango ducha con salida agua pared.

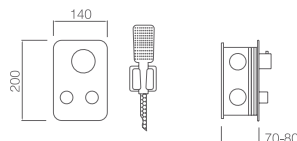
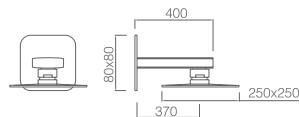

PORTUGAL

SERIE

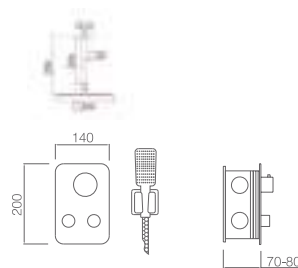

Ref. : GTP022

Rociador de acero inox. Cuadrado 25X25cm, extraplano, cromado y antical.

Tubo salida techo latón cromado.

Mango ducha cuadrado.

Grifería termostática de latón cromado, 2 vías con pulsador y caja de registro.

Presión máximo 6 at.mínimo 1 at.

Caudal medio 12 l/min.

Distribuidor de pulsador de latón cromado.

Flexo reforzado PVC 1,5 m

Cartucho termostático autolimpiable TURN CLEAN SYSTEM.

Soporte mango ducha con salida agua pared.



Vídeo
spot



Vídeo
técnico
profesional







MADEIRA NEGRO MATE

SERIE

MADEIRA

NEGRO MATE

SERIE

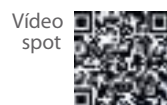

Ref. : GTM021/NG

Rociador de acero inox. Cuadrado 25X25cm, extraplano, negro mate y antical.

Tubo salida pared latón negro mate.

Mango ducha cuadrado.

Grifería termostática de latón negro mate, 2 vías con pulsador y caja de registro.

Presión máximo 6 at.mínimo 1 at.

Caudal medio 12 l/min.

Distribuidor de pulsador de latón negro mate.

Flexo reforzado PVC 1,5 m

Cartucho termostático autolimpiable TURN CLEAN SYSTEM.

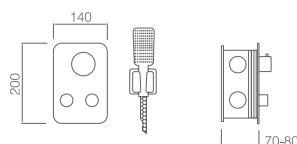
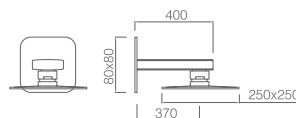

PORTUGAL

NEGRO MATE

SERIE



Vídeo spot



Vídeo técnico profesional



Ref. : GTP022/NG

Rociador de acero inox. Cuadrado 25X25cm, extraplano, negro mate y antical.
Tubo salida techo latón negro mate.
Mango ducha cuadrado.
Grifería termostática de latón negro mate, 2 vías con pulsador y caja de registro.
Presión máximo 6 at.mínimo 1 at.
Caudal medio 12 l/min.
Distribuidor de pulsador de latón negro mate.
Flexo reforzado PVC 1,5 m

Cartucho termostático autolimpiable TURN CLEAN SYSTEM.

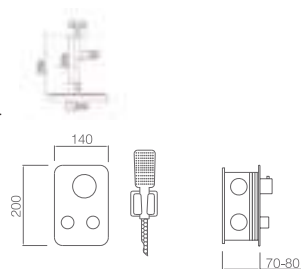

8

410201

401629



HIDRA

SERIE



HIDRA

SERIE



Vídeo spot 

Vídeo técnico profesional 



Ref. : GPH035

Rociador de acero inox. ovalado 20x30cm, extraplano, cromado y antical.
Tubo salida pared de latón..
Mango ducha ovalado.
Grifería termostática de latón cromado, 2 vías con pulsadores y caja de registro.
Presión máximo 6 at.mínimo 1 at.
Caudal medio 12 l/min.
Distribuidores con pulsador de latón cromado.
Flexo reforzado PVC 1,5 m
Cartucho termostático autolimpiante TURN CLEAN SYSTEM.
Soporte mango ducha con salida agua pared.



FEROE

SERIE



Vídeo spot



Vídeo técnico profesional



Ref. : GPF036

Rociador de acero inox. ovalado 20x30cm, extraplano, cromado y antical.

Tubo salida techo de latón..

Mango ducha ovalado.

Grifería termostática de latón cromado, 2 vías con pulsadores y caja de registro.

Presión máximo 6 at.mínimo 1 at.

Caudal medio 12 l/min.

Distribuidores con pulsador de latón cromado.

Flexo reforzado PVC 1,5 m

Cartucho termostático autolimpiable TURN CLEAN SYSTEM.

Soporte mango ducha con salida agua pared.

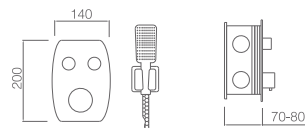
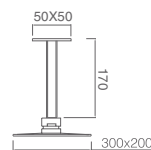



HIDRA NEGRO MATE

SERIE

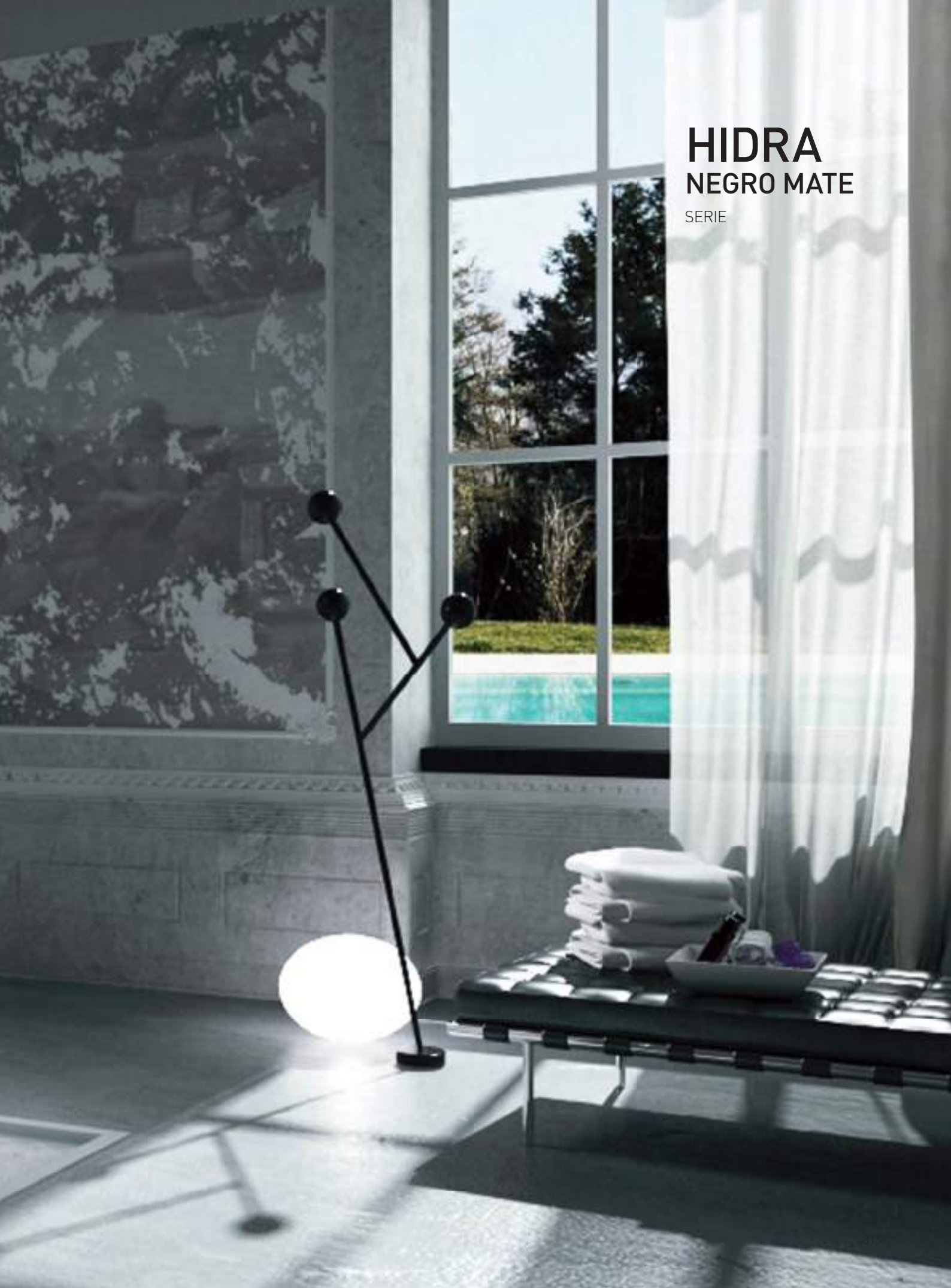

HIDRA NEGRO MATE

SERIE





TURN CLEAN SYSTEM
Sistema patentado

Ref. : GPH035/NG

Rociador de acero inox. ovalado 20x30cm, extraplano, negro mate y antical.
 Tubo salida pared de latón.
 Mango ducha ovalado.
 Grifería termostática de latón negro mate, 2 vías con pulsadores y caja de registro.
 Presión máximo 6 at.mínimo 1 at.
 Caudal medio 12 l/min.
 Distribuidores con pulsador de latón negro mate.
 Flexo reforzado PVC 1,5 m
Cartucho termostático autolimpiable TURN CLEAN SYSTEM.
 Soporte mango ducha con salida agua pared.



Vídeo spot



Vídeo técnico profesional





8 410201 522621



FEROE

NEGRO MATE

SERIE



Ref. : GPF036/NG

Rociador de acero inox. ovalado 20x30cm, extraplano, negro mate y antical.

Tubo salida techo de latón.

Mango ducha ovalado.

Grifería termostática de latón negro mate, 2 vías con pulsadores y caja de registro.

Presión máximo 6 at.mínimo 1 at.

Caudal medio 12 l/min.

Distribuidores con pulsador de latón negro mate.

Flexo reforzado PVC 1,5 m

Cartucho termostático autolimpiable TURN CLEAN SYSTEM.

Soporte mango ducha con salida agua pared.

Vídeo
spot



Vídeo
técnico
profesional

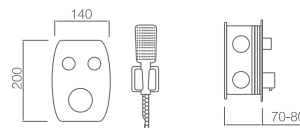
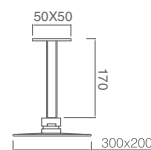

OLIMPO

SERIE





OLIMPO

SERIE

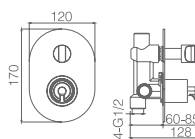
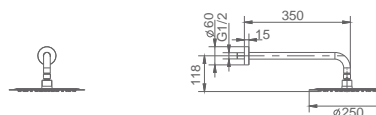

Ref. : GPC033

Rociador de acero inox. redondo Ø25cm, extraplano, cromado y antical.

Tubo salida pared de latón.

Mango ducha redondo.

Grifería monomando de latón cromado, 2 vías.

Presión máximo 6 at.mínimo 1 at.

Caudal medio 12 l/min.

Distribuidor de latón cromado.

Flexo reforzado PVC 1,5 m

Cartucho monomando 35mm.

Soporte mango ducha con salida agua pared.



VESUBIO

SERIE

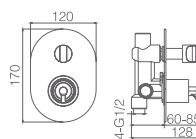
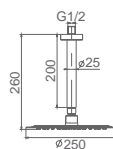

Ref. : GTV038

Rociador de acero inox. redondo Ø25cm, extraplano, cromado y antical.

Tubo salida techo de latón.

Mango ducha redondo.

Grifería monomando de latón cromado, 2 vías.

Presión máximo 6 at.mínimo 1 at.

Caudal medio 12 l/min.

Distribuidor de latón cromado.

Flexo reforzado PVC 1,5 m

Cartucho monomando 35mm.

Soporte mango ducha con salida agua pared.





OLIMPO NEGRO MATE

SERIE



OLIMPO

SERIE



Ref. : GPC033/NG

Rociador de acero inox. redondo Ø25cm, extraplano, negro mate y antical.

Tubo salida pared de latón.

Mango ducha redondo.

Grifería monomando de latón negro mate, 2 vías.

Presión máximo 6 at.mínimo 1 at.

Caudal medio 12 l/min.

Distribuidor de latón negro mate.

Flexo reforzado PVC 1,5 m

Cartucho monomando 35mm.

Soporte mango ducha con salida agua pared.



VESUBIO

SERIE



Ref. : GTV038/NG

Rociador de acero inox. redondo Ø25cm, extraplano, negro mate y antical.
Tubo salida techo de latón.
Mango ducha redondo.
Grifería monomando de latón negro mate, 2 vías.
Presión máximo 6 at.mínimo 1 at.
Caudal medio 12 l/min.
Distribuidor de latón negro mate.
Flexo reforzado PVC 1,5 m
Cartucho monomando 35mm.
Soporte mango ducha con salida agua pared.



8 410201 536628





OLIMPO NEGRO ORO ROSA

SERIE



OLIMPO

SERIE



Ref. : GPC033/NOR

Rociador de acero inox. redondo Ø25cm, extraplano, oro rosa y antical.
Tubo salida pared de latón negro mate y oro rosa.
Mango ducha redondo.
Grifería monomando de latón negro mate y oro rosa, 2 vías.
Presión máximo 6 at.mínimo 1 at.
Caudal medio 12 l/min.
Distribuidor de latón negro mate y oro rosa.
Flexo reforzado PVC 1,5 m
Cartucho monomando 35mm.
Soporte mango ducha con salida agua pared.



VESUBIO

SERIE



Ref. : GTV038/NOR

Rociador de acero inox. redondo Ø25cm, extraplano, oro rosa y antical.
Tubo salida techo de latón negro mate y oro rosa.
Mango ducha redondo.
Grifería monomando de latón negro mate y oro rosa, 2 vías.
Presión máximo 6 at.mínimo 1 at.
Caudal medio 12 l/min.
Distribuidor de latón negro mate y oro rosa.
Flexo reforzado PVC 1,5 m
Cartucho monomando 35mm.
Soporte mango ducha con salida agua pared.



SUECIA

SERIE





SUECIA

SERIE



Ref. : BDC032-6/CR

Rociador de acero inox. Cuadrado 25X25cm, extraplano, cromado y antical.
Tubo salida pared de latón.
Mango ducha cuadrado.
Grifería monomando de latón cromado, de 2 vías.
Presión máximo 6 at.mínimo 1 at.
Caudal medio 12 l/min.
Distribuidor cuadrado de latón cromado.
Flexo reforzado PVC 1,5 m
Cartucho monomando 35mm.
Soporte mango ducha con salida agua pared.



ESTOCOLMO

SERIE



Ref. : BDES37-6/CR

Rociador de acero inox. Cuadrado 25X25cm, extraplano, cromado y antical.
Tubo salida techo de latón.
Mango ducha cuadrado.
Grifería monomando de latón cromado, de 2 vías.
Presión máximo 6 at.mínimo 1 at.
Caudal medio 12 l/min.
Distribuidor cuadrado de latón cromado.
Flexo reforzado PVC 1,5 m
Cartucho monomando 35mm.
Soporte mango ducha con salida agua pared.





SUECIA NEGRO MATE

SERIE



SUECIA

SERIE



Ref. : BDC032-6/NG

Rociador de acero inox. Cuadrado 25X25cm, extraplano, negro mate y antical.
Tubo salida pared de latón.
Mango ducha cuadrado.
Grifería monomando de latón negro mate, de 2 vías.
Presión máximo 6 at.mínimo 1 at.
Caudal medio 12 l/min.
Distribuidor cuadrado de latón negro mate.
Flexo reforzado PVC 1,5 m
Cartucho monomando 35mm.
Soporte mango ducha con salida agua pared.



ESTOCOLMO

SERIE



Ref. : BDES37-6/NG

Rociador de acero inox. Cuadrado 25X25cm, extraplano, negro mate y antical.

Tubo salida techo de latón.

Mango ducha cuadrado.

Grifería monomando de latón negro mate, de 2 vías.

Presión máximo 6 at.mínimo 1 at.

Caudal medio 12 l/min.

Distribuidor cuadrado de latón negro mate.

Flexo reforzado PVC 1,5 m

Cartucho monomando 35mm.

Soporte mango ducha con salida agua pared.



SUECIA

NEGRO ORO ROSA

SERIE





SUECIA

SERIE

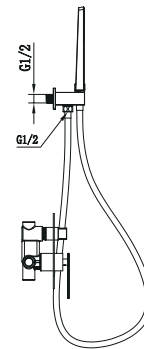
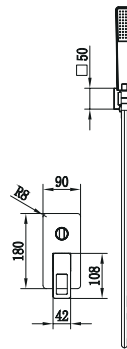
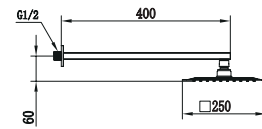
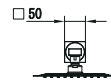

Ref. : BDC032-6/NOR

Rociador de acero inox. Cuadrado 25X25cm, extraplano, oro rosa y antical.

Tubo salida pared de latón negro mate y oro rosa.

Mango ducha cuadrado.

Grifería monomando de latón negro mate y oro rosa, de 2 vías.

Presión máximo 6 at.mínimo 1 at.

Caudal medio 12 l/min.

Distribuidor cuadrado de latón negro mate y oro rosa.

Flexo reforzado PVC 1,5 m

Cartucho monomando 35mm.

Soporte mango ducha con salida agua pared.



ESTOCOLMO

SERIE

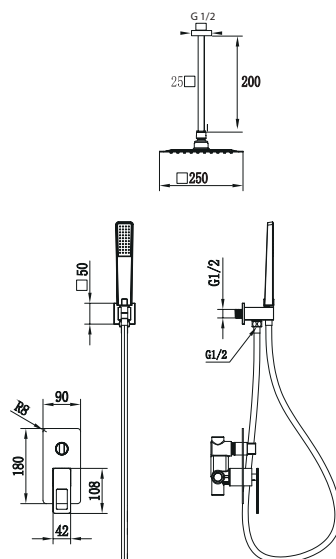

Ref. : BDES37-6/NOR

Rociador de acero inox. Cuadrado 25X25cm, extraplano, oro rosa y antical.

Tubo salida techo de latón negro mate y oro rosa.

Mango ducha cuadrado.

Grifería monomando de latón negro mate y oro rosa, de 2 vías.

Presión máximo 6 at.mínimo 1 at.

Caudal medio 12 l/min.

Distribuidor cuadrado de latón negro mate y oro rosa.

Flexo reforzado PVC 1,5 m

Cartucho monomando 35mm.

Soporte mango ducha con salida agua pared.



SUECIA NEGRO ORO

SERIE





SUECIA

SERIE

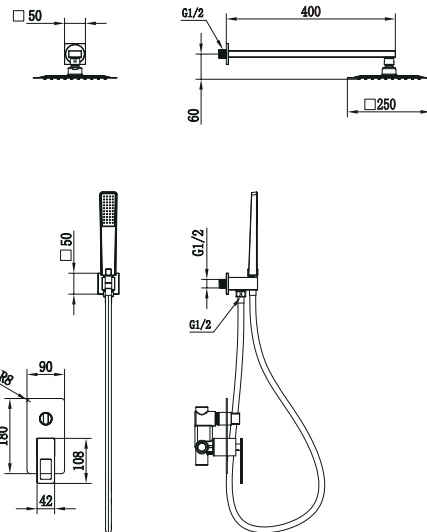

Ref. : BDC032-6/NGOLD

Rociador de acero inox. Cuadrado 25X25cm, extraplano, oro brillo y antical.
Tubo salida pared de latón negro mate y oro brillo.
Mango ducha cuadrado.
Grifería monomando de latón negro mate y oro brillo, de 2 vías.
Presión máximo 6 at.mínimo 1 at.
Caudal medio 12 l/min.
Distribuidor cuadrado de latón negro mate y oro brillo.
Flexo reforzado PVC 1,5 m
Cartucho monomando 35mm.
Soporte mango ducha con salida agua pared.



ESTOCOLMO

SERIE

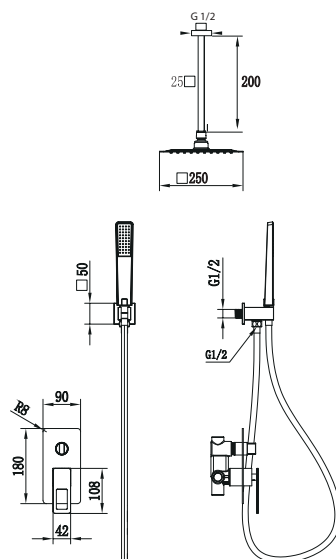

Ref. : BDES37-6/NGOLD

Rociador de acero inox. Cuadrado 25X25cm, extraplano, oro brillo y antical.

Tubo salida techo de latón negro mate y oro brillo.

Mango ducha cuadrado.

Grifería monomando de latón negro mate y oro brillo, de 2 vías.

Presión máximo 6 at.mínimo 1 at.

Caudal medio 12 l/min.

Distribuidor cuadrado de latón negro mate y oro brillo.

Flexo reforzado PVC 1,5 m

Cartucho monomando 35mm.

Soporte mango ducha con salida agua pared.



SUECIA

SERIE



Ref. : BDC032-4

Grifería empotrada monomando latón.
Cromado
Box de registro.

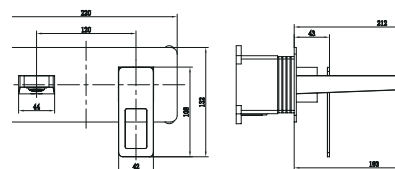

SUECIA

SERIE



Ref. : **BDC032-4NG**

Grifería empotrada monomando de latón.
Negro mate.
Box de registro.

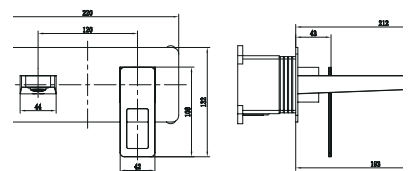

SUECIA

SERIE



Ref. : BDC032-4NOR

Grifería empotrada monomando de latón.
Negro mate, oro rosa.
Box de registro.

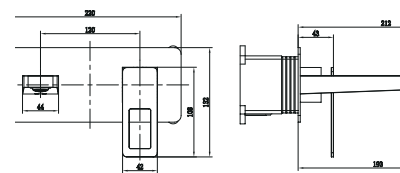

SUECIA

SERIE



Ref. : **BDC032-4NGOLD**

Grifería empotrada monomando de latón.
Negro mate, oro brillo.
Box de registro.

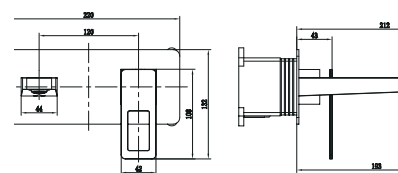

MALTA

SERIE

Ref. : GLM021

Grifería empotrada monomando
Latón cromado
Box de registro.
Rosca de 1/2" agregada al caño.
Cartucho 35mm.



Grifería con
certificación

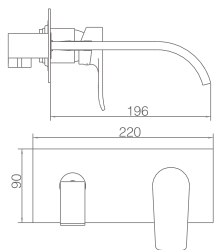

SUIZA

SERIE

Ref. : **GLE020**

Grifería empotrada monomando
Latón cromado
Box de registro.
Rosca 1/2" pieza independiente (machón)



Grifería con certificación

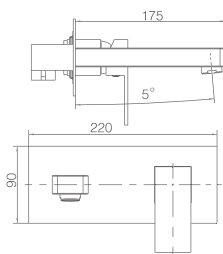

SUIZA NEGRO MATE

SERIE

Ref. : GLE020/NG

Grifería empotrada monomando
Latón negro
Box de registro.



Grifería con
certificación

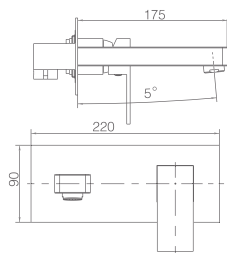

SUIZA BLANCO MATE

SERIE

Ref. : GLE020/BL

Grifería empotrada monomando
Latón blanco
Box de registro.



Grifería con
certificación

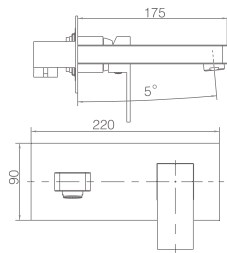



FIYI
SERIE



Ref. : GLF016

Grifería empotrada monomando
Latón cromado
En dos partes independientes.

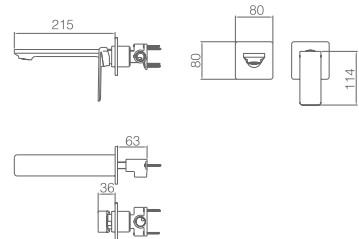



FIYI BLANCO MATE

SERIE

Ref. : **GLF016BL**

Grifería empotrada monomando.
Latón blanco mate.
En dos partes independientes.

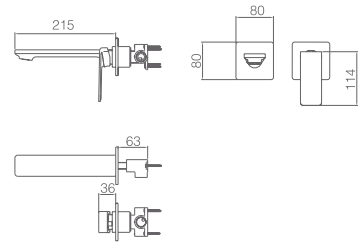



FIYI NEGRO MATE

SERIE

Ref. : GLF016NG

Grifería empotrada monomando.
Latón negro mate.
En dos partes independientes.

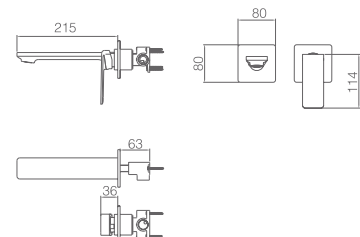



Ref. : GLI019CR

Grifería empotrada monomando
Latón cromado
En dos partes independientes.



MILOS
SERIE

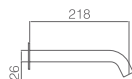



Ref. : **GLI019BL**

Grifería empotrada monomando.
Latón blanco mate.
En dos partes independientes.

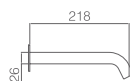

MILOS
BLANCO MATE

SERIE



Ref. : **GLI019NG**

Grifería empotrada monomando.
Latón negro mate.
En dos partes independientes.

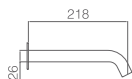

MILOS NEGRO MATE

SERIE



Ref. : GLI019/NOR

Grifería empotrada monomando.
Latón negro oro rosa.
En dos partes independientes.

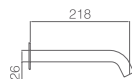

MILOS

NEGRO ORO ROSA

SERIE





ETNA

SERIE



Ref. : GLT023

Grifería empotrada monomando
Latón cromado.
En dos partes independientes.

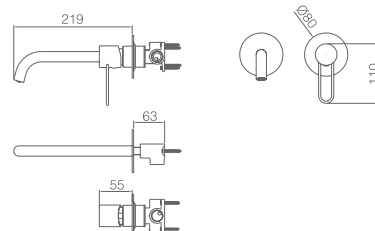

ETNA NEGRO MATE

SERIE

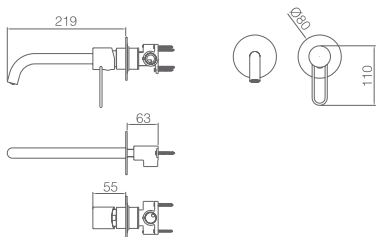

Ref. : GLT023/NG

Grifería empotrada monomando
Latón negro mate.
En dos partes independientes.







ETNA
BLANCO MATE
SERIE



Ref. : GLT023/BL

Grifería empotrada monomando
Latón blanco mate.
En dos partes independientes.

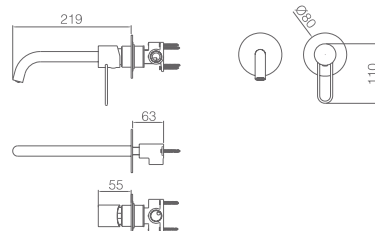

OLIMPO

SERIE





Ref. : GLC033

Grifería empotrada monomando
Laton cromado.
En dos partes independientes.

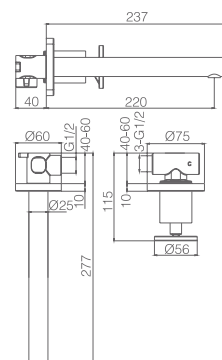



OLIMPO

SERIE



Ref. : **GLC033/NOR**

Grifería empotrada monomando
Negro mate y oro rosa.
En dos partes independientes

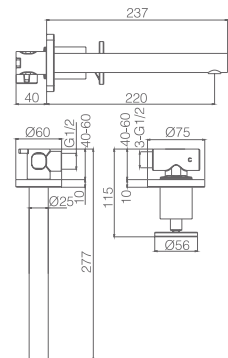



OLIMPO

SERIE

Ref. : **GLC033/NG**

Grifería empotrada monomando
 Negro mate.
 En dos partes independientes.

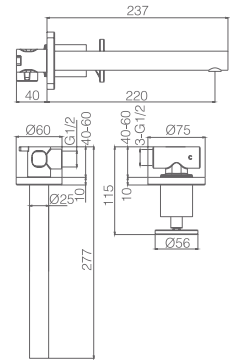

TERMOSTÁTICOS EMPOTRADOS



Ref. : GST22V (dos vías)
 Grifería empotrada termostática,
 dos vías.
 Latón cromado
 Box de registro.
 Cartucho termostático Vernet.



Ref. : GST33V (tres vías)
 Grifería empotrada termostática,
 tres vías.
 Latón cromado
 Box de registro.
 Cartucho termostático TURN
 CLEAN SYSTEM.

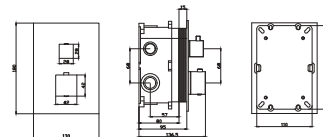

Ref. : GST44V (cuatro vías)
 Grifería empotrada termostática,
 cuatro vías.
 Latón cromado
 Box de registro.
 Cartucho termostático TURN
 CLEAN SYSTEM.

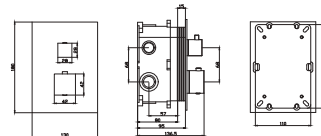

Ref. : GSP02V
 Grifería empotrada termostática
 2 vías.
 Con pulsador.
 Latón cromado
 Box de registro.
 Cartucho termostático TURN
 CLEAN SYSTEM.

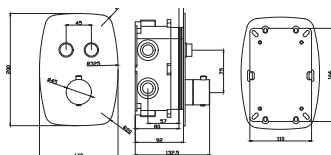

Ref. : CTP02V
 Grifería empotrada termostática
 2 vías.
 Con pulsador.
 Latón cromado
 Box de registro.
 Cartucho termostático TURN
 CLEAN SYSTEM.

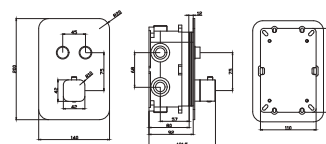

MONOMANDOS EMPOTRADOS



Ref. : GSM01V (una vía)
 Grifería empotrada monomando,
 1 vías
 Latón cromado
 Cartucho cerámico 35mm



Ref. : GSM02V (dos vías)
 Grifería empotrada monomando,
 2 vías.
 Latón cromado
 Box de registro.
 Cartucho cerámico 35mm

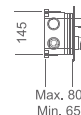

Ref. : GSM03V (tres vías)
 Grifería empotrada monomando,
 3 vías.
 Latón cromado
 Box de registro.
 Cartucho cerámico 35mm



Ref. : GSM04V (cuatro vías)
 Grifería empotrada monomando,
 4 vías.
 Latón cromado
 Box de registro.
 Cartucho cerámico 35mm

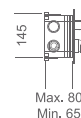

GRIFERÍA DE COCINA











TORINO

SERIE



Ref.: GCE007

Grifería monomando extraíble.
Cuerpo de grifería en Latón cromado.
Cartucho cerámico de 35 mm.
Latiguillos 50cm.



Grifería con certificación

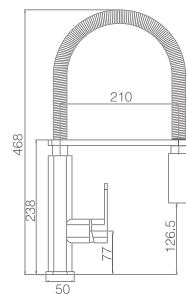



SAMOA

SERIE

Ref.: **GCE017**

Grifería monomando extraíble.
Cuerpo de grifería cromado.
Cartucho cerámico de 25 mm.
Latiguillos 50cm.

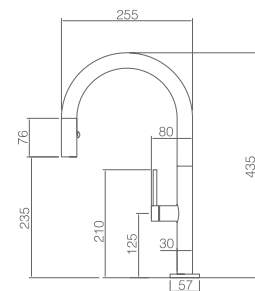



SAMOA BLANCO MATE

SERIE

Ref. : **GCE017/BL**

Grifería monomando extraíble.
Cuerpo de grifería blanco mate.
Cartucho cerámico de 25 mm.
Latiguillos 50cm.

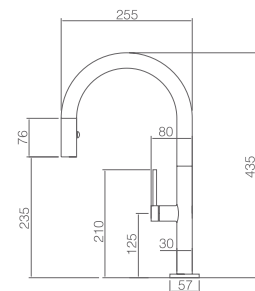



SAMOA NEGRO MATE

SERIE

Ref.: **GCE017/NG**

Grifería monomando extraíble.
Cuerpo de grifería negro mate.
Cartucho cerámico de 25 mm.
Latiguillos 50cm.

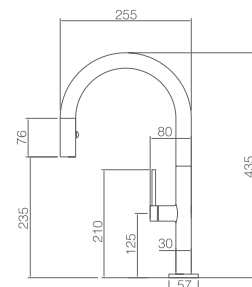



SAMOA

NEGRO ORO ROSA

SERIE

Ref. : **GCE017/NOR**

Grifería monomando extraíble.
 Cuerpo de grifería negro oro rosa.
 Cartucho cerámico de 25 mm.
 Latiguillos 50cm.

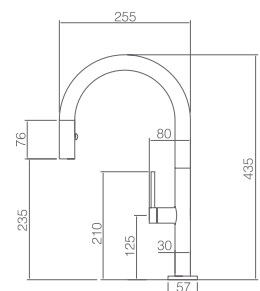





MENORCA

SERIE

Ref. : GCE019

Grifería monomando extraíble.
Cuerpo de grifería en Latón cromado.
Cartucho cerámico de 35 mm.
Latiguillos 50cm.

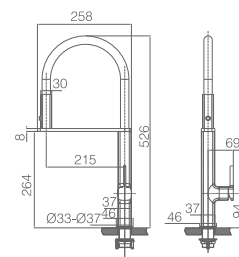

MENORCA

NEGRO MATE

SERIE



Ref.: GCE019/NG

Grifería monomando extraíble.
Cuerpo de grifería en Latón negro mate.
Cartucho cerámico de 35 mm.
Latiquillos 50cm.

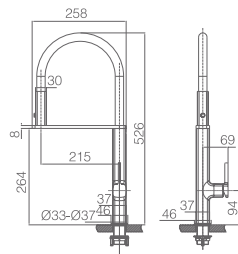





ITACA

SERIE



Ref.: **GCE018**

Grifería monomando plegable.
Cuerpo de grifería latón cromado.D
Cartucho cerámico de 25 mm.
Latiguillos 50cm.

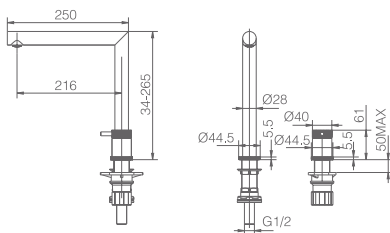

ITACA NEGRO MATE

SERIE

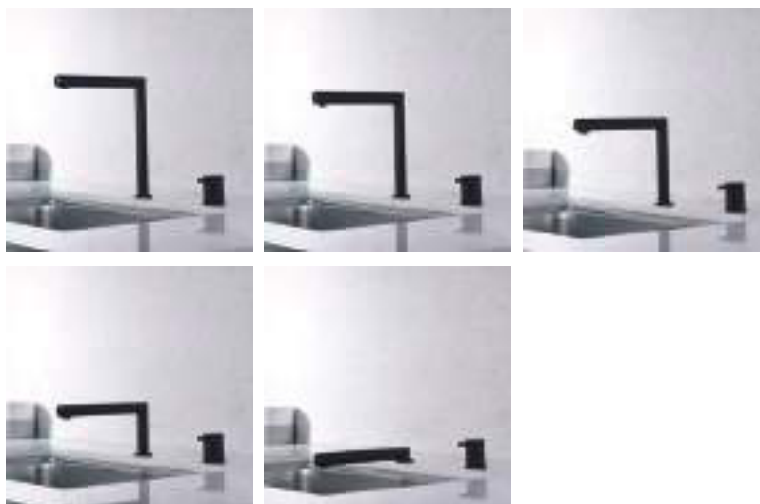

Ref.: **GCE018/NG**

Grifería monomando plegable.
Cuerpo de grifería latón negro mate.
Cartucho cerámico de 25 mm.
Latiguillos 50cm.

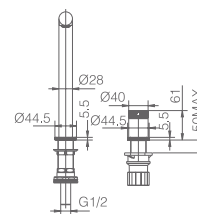
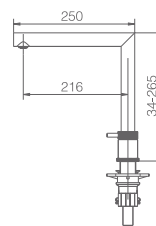





MANACOR

SERIE

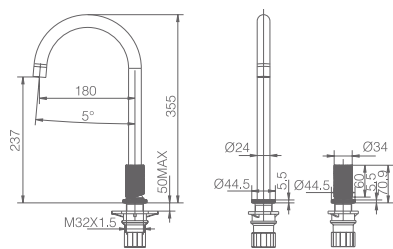

Ref. : **GCM001**

Grifería monomando.
Cuerpo de grifería latón cromado.
Cartucho cerámico de 25 mm.
Latiguillos 50cm.



MANACOR

NEGRO MATE

SERIE



Ref.: **GCM001/NG**

Grifería monomando.
Cuerpo de grifería latón negro mate.
Cartucho cerámico de 25 mm.
Latiguillos 50cm.

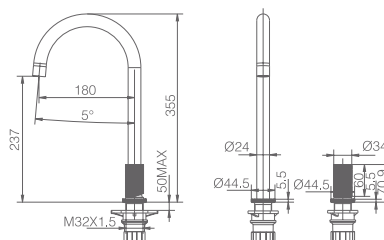

MANACOR

BLANCO MATE

SERIE



Ref.: **GCM001/BL**

Grifería monomando.
Cuerpo de grifería latón blanco mate.
Cartucho cerámico de 25 mm.
Latiguillos 50cm.

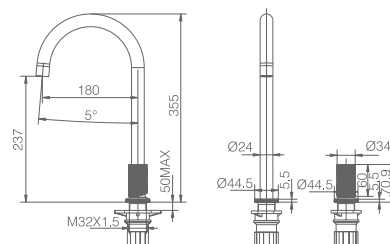



OLIMPO

SERIE



Ref. : **GCC033**

Grifería monomando.
Cuerpo de grifería latón cromado.
Cartucho cerámico de 25 mm.
Latiguillos 50cm.

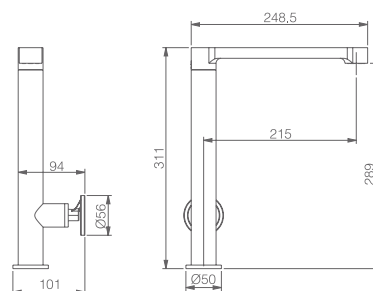

OLIMPO

NEGRO ORO ROSA

SERIE



Ref. : **GCC033/NOR**

Grifería monomando.
Cuerpo de grifería latón negro oro rosa.
Cartucho cerámico de 25 mm.
Latiguillos 50cm.

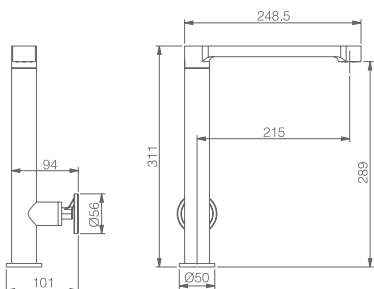





OLIMPO NEGRO MATE

SERIE



Ref. : **GCC033/NG**

Grifería monomando.
Cuerpo de grifería latón negro mate.
Cartucho cerámico de 25 mm.
Latiguillos 50cm.

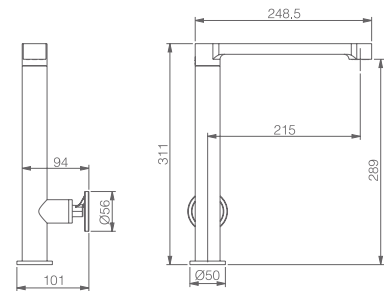

LANZAROTE

SERIE

Ref.: GCE015

Grifería monomando extraíble.
Cuerpo de grifería en Latón cromado.
Cartucho cerámico de 35 mm.
Latiguillos 50cm.

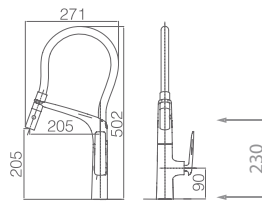





TOULOUSE

SERIE



Ref.: **GCE008**

Grifería monomando extraíble.
Cuerpo de grifería en Latón cromado.
Cartucho cerámico de 35 mm.
Latiguillos 50cm.

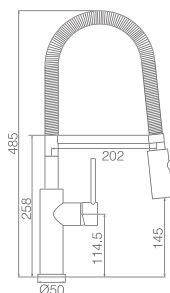

Flexible 50 cm

LAOS

SERIE

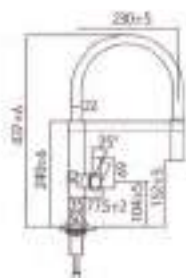

Altura
mínima 37 cm



Ref.: **GCE011**

Grifería monomando extraíble.
Cuerpo de grifería en Latón cromado.
Cartucho cerámico Sedal de 25 mm.
Latiguillos 50cm.



Ref.: **GCE012**

Grifería monomando extraíble.
Cuerpo de grifería en negro mate.
Cartucho cerámico Sedal de 25 mm.
Latiguillos 50cm.



Ref.: **GCE014**

Grifería monomando extraíble.
Cuerpo de grifería en blanco mate.
Cartucho cerámico Sedal de 25 mm.
Latiguillos 50cm.







MALTA

SERIE



Ref. : **GCE006**

Grifería monomando extraíble.
Cuerpo de grifería cromado.
Cartucho cerámico de 35 mm.
Latiguillos 50cm.



Grifería con
certificación

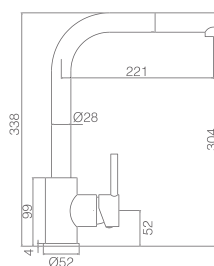

MALTA BLANCO MATE

SERIE

Ref. : **GCE006/BL**

Grifería monomando extraíble.
Cuerpo de grifería blanco mate.
Cartucho cerámico de 35 mm.
Latiguillos 50cm.



Grifería con
certificación

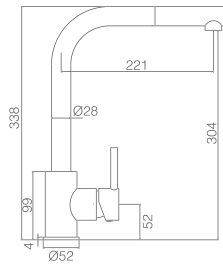





MALTA NEGRO MATE

SERIE

Ref. : GCE006/NG

Grifería monomando extraíble.
Cuerpo de grifería negro mate.
Cartucho cerámico de 35 mm.
Latiguillos 50cm.



Grifería con
certificación

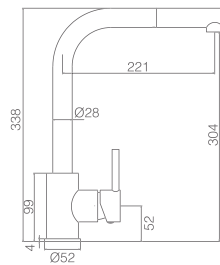

VENECIA

SERIE



Ref. : **GCE100**

Grifería monomando de cocina.
Cuerpo de grifería en Latón cromado.
Cartucho cerámico de 35 mm.
Latiguillos 50cm.

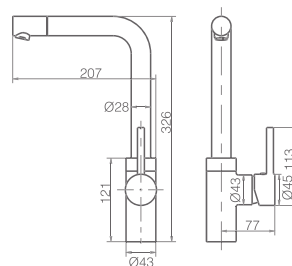

Grifería con certificación







CONSTANZA

SERIE



Ref.: **GCE005**

Grifería monomando extraíble.
Cuerpo de grifería cromado.
Cartucho cerámico de 35 mm.
Latiguillos 50cm.

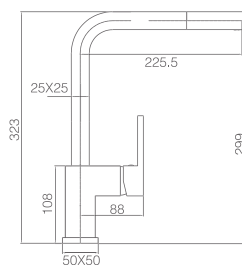

Grifería con
certificación



PIREO

SERIE



Ref. : GOS003

Grifería monomando de dos vías (osmosis)
Cuerpo de grifería en Latón cromado.
Cartucho cerámico de 35 mm.
Latiguillos 50cm.

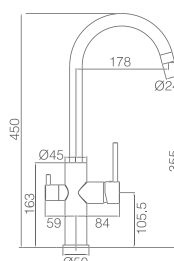

Grifería con certificación



Osmosis



Osmosis



CAPRI

SERIE



Ref.: **GOS002**

Grifería monomando de dos vías (osmosis)
Cuerpo de grifería en Latón cromado.
Cartucho cerámico de 35 mm.
Latiguillos 50cm.

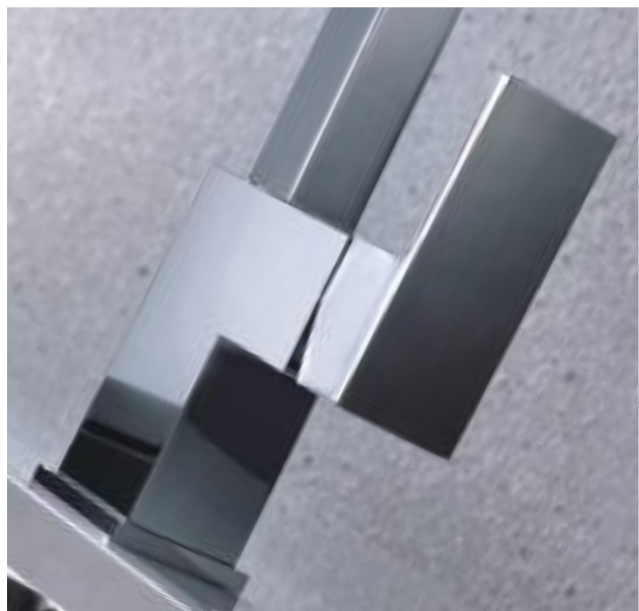
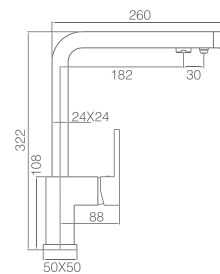

MONTECARLO

SERIE



Ref. : **GOS001**

Grifería monomando de dos vías (osmosis)
Cuerpo de grifería en Latón cromado.
Cartucho cerámico de 35 mm.
Latiguillos 50cm.

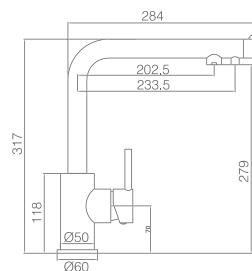

Osmosis



MARSELLA

SERIE



Ref. : **GOS004**

Grifería monomando de dos vías (osmosis)
Cuerpo de grifería en Latón cromado.
Cartucho cerámico de 35 mm.
Latiguillos 50cm.

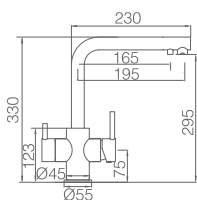

Osmosis





LYON

SERIE

Líneas simples y depuradas para un modelo que aúnan calidad y diseño.



Ref. : GCR002

Grifería monomando de cocina.
Cuerpo de grifería en Latón cromado.
Cartucho cerámico de 35 mm.
Latiguillos 50cm.

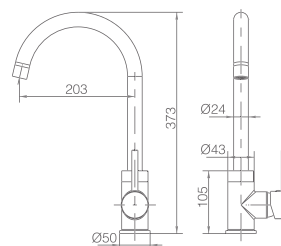

Grifería con
certificación



MIKONOS

SERIE



Ref.: GCC002

Grifería monomando de cocina.
Cuerpo de grifería en Latón cromado.
Giro 360°
Cartucho cerámico de 35 mm.
Latiguillos 50cm.



Grifería con certificación

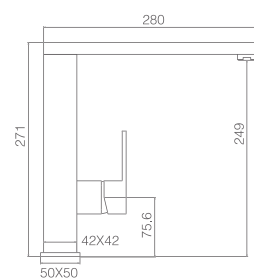





COX

SERIE



Ref. : GCC001

Grifería monomando de cocina.
Cuerpo de grifería en Latón cromado.
Cartucho cerámico de 35 mm.
Latiguillos 50cm.

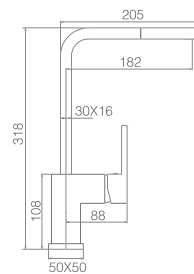

Grifería con certificación



VERONA

SERIE

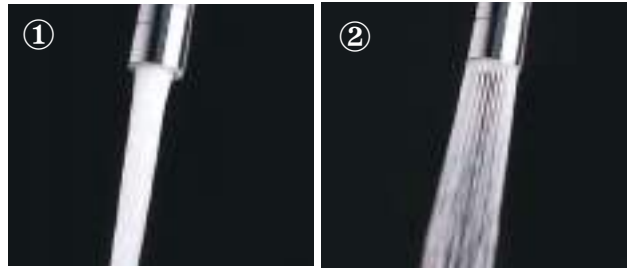

Ref. : GCE010

Grifería monomando de cocina.
Cuerpo de grifería en latón cromado y
tubo flexible en negro mate.
Cartucho cerámico de 35 mm.
Aireador de dos posiciones.
Latiguillos 50 cm.

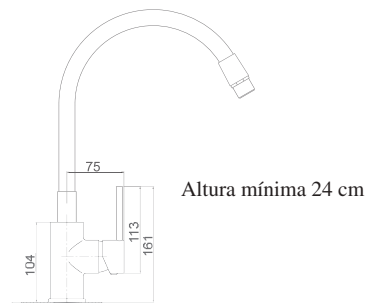

Test de la grifería
aprobado





PROFESSIONAL
IMEX
DESIGN



VIENA

SERIE

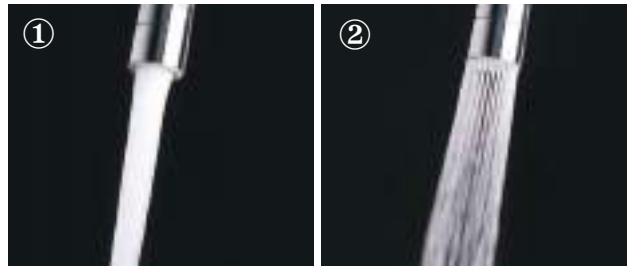

Ref. : **GCE009**

Grifería monomando de cocina.
Cuerpo de grifería en Latón cromado y tubo flexible en blanco mate.
Cartucho cerámico de 35 mm.
Aireador de dos posiciones.
Latiguillos 50cm.

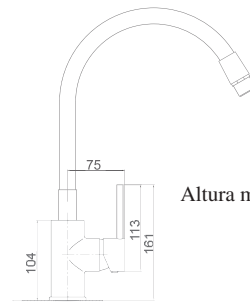

Altura mínima 24 cm



Test de la grifería aprobado



TOKYO

SERIE

Calidad y prestaciones dentro de un producto llevado a la máxima expresión. De gran utilidad son sus dos funciones de salida de agua que nos permiten aumentar la presión con un simple giro.

Ref. : GCE016

Grifería monomando de cocina.
Cuerpo de grifería en Latón cromado y tubo flexible negro mate.
Cartucho cerámico de 35 mm.
Aireador de dos posiciones.
Latiguillos 50 cm.



Test de la grifería aprobado

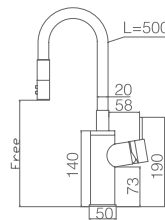

Altura máxima recomendada 47 cm





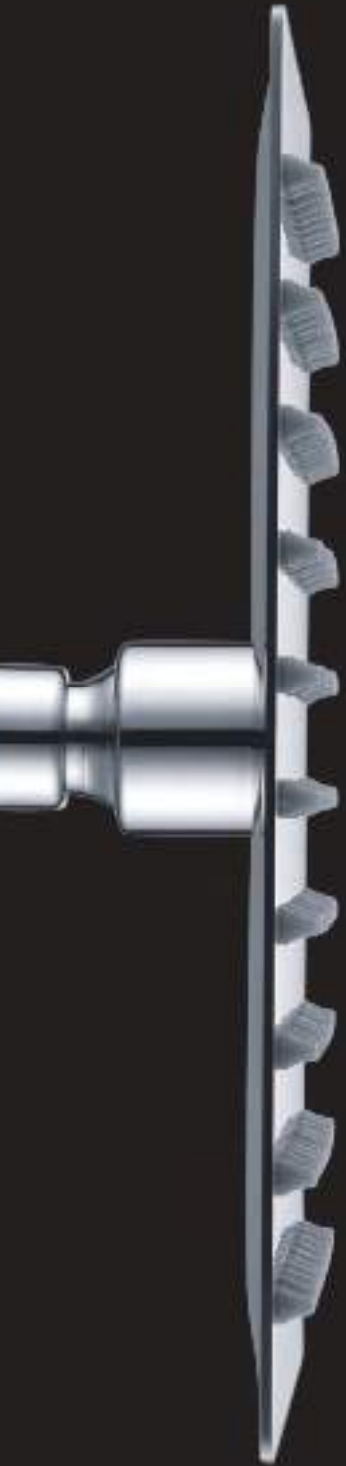

ROCIADORES

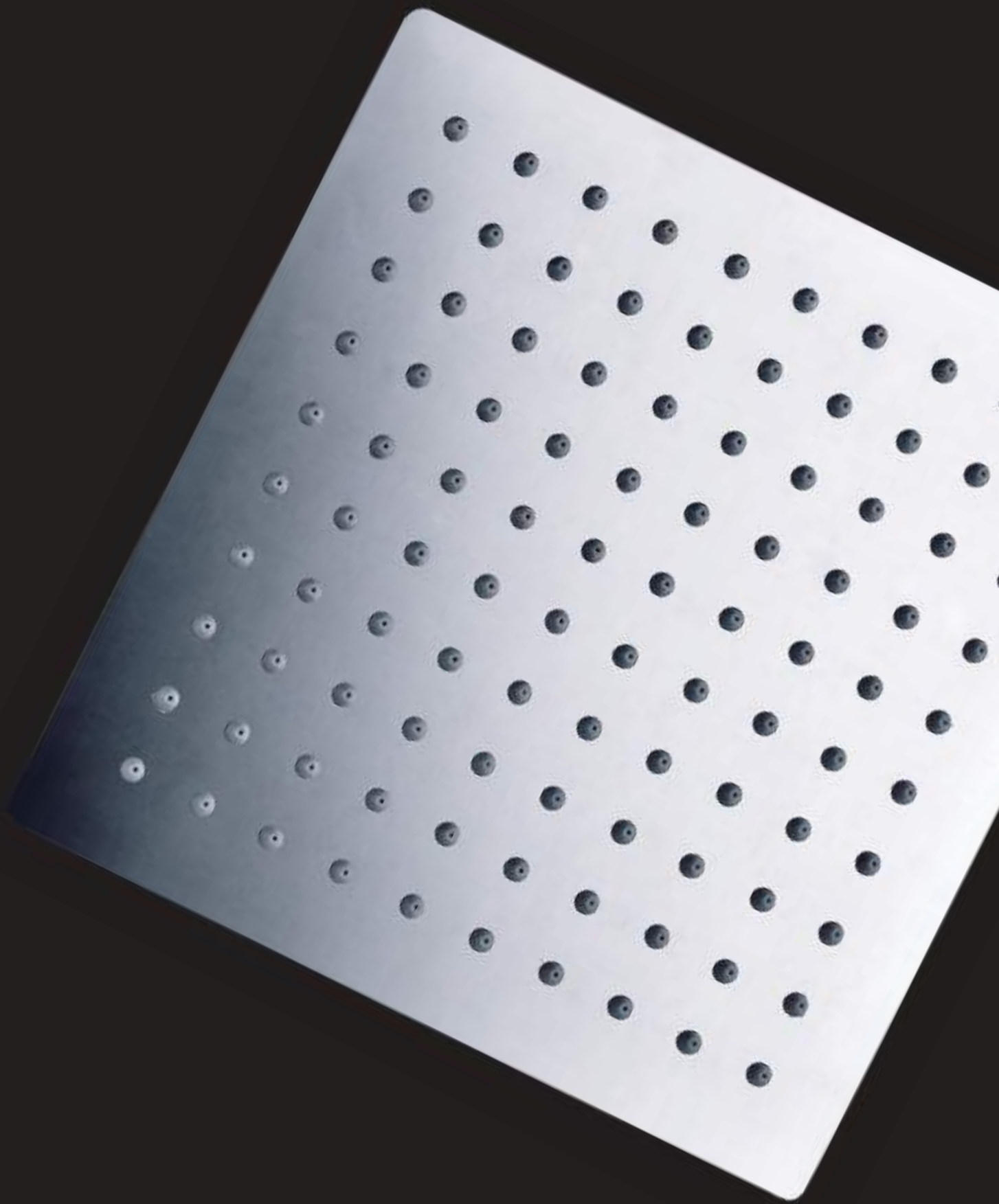





Ref. : RDN001

Dimensiones Ø20cm
Rociador Redondo Extraplano con
Material : Acero Inox S304
Acababo : Cromado



Ref. : RDN002

Dimensiones Ø30cm
Rociador Redondo Extraplano con
Material : Acero Inox S304
Acababo : Cromado



Ref. : RDN003

Dimensiones Ø25cm
Rociador Redondo Extraplano con
Material : Acero Inox S304
Acababo : Cromado



Ref. : RDN004

Dimensiones Ø40cm
Rociador Redondo Extraplano con
Material : Acero Inox S304
Acababo : Cromado





Ref. : RDC001

Dimensiones 20X20cm
Rociador Cuadrado Extraplano
Material : Acero Inox S304
Acababo : Cromado



9 780201 373226



Ref. : RDC003

Dimensiones 30X30cm
Rociador Cuadrado Extraplano
Material : Acero Inox S304
Acababo : Cromado



9 780201 373424



Premarco 30x30cm

Ref.: **PTC030**



6 410201 169628

Premarco 30x30cm blanco

Ref.: **PTC030/BL**



6 410201 319627

Premarco 30x30cm negro

Ref.: **PTC030/NG**



6 410201 320623



Ref. : RDC002

Dimensiones 25X25cm
Rociador Cuadrado Extraplano
Material : Acero Inox S304
Acababo : Cromado



9 780201 373325



Ref. : RDC004

Dimensiones 40X40cm
Rociador Cuadrado Extraplano
Material : Acero Inox S304
Acababo : Cromado



9 780201 373523



Premarco 40x40cm

Ref.: **PTC040**



6 410201 170624

Premarco 40x40cm blanco

Ref.: **PTC040/BL**



6 410201 321620

Premarco 40x40cm negro

Ref.: **PTC040/NG**



6 410201 322627

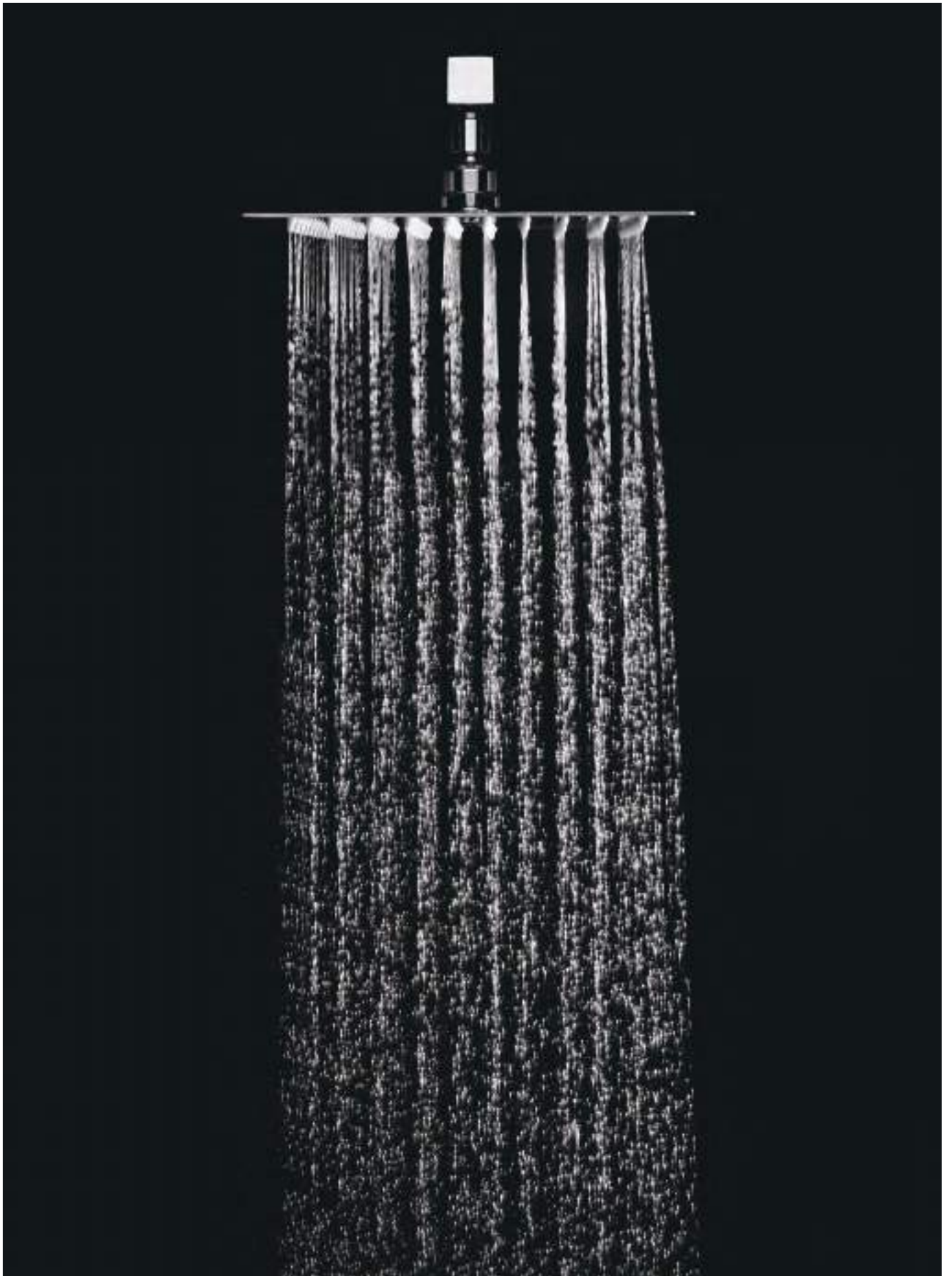



Ref. : RDN001/BL

Dimensiones Ø20cm
Rociador Redondo
Acabado : Blanco mate



Ref. : RDN001/NG

Dimensiones Ø20cm
Rociador Redondo
Acabado : Negro mate



Ref. : RDN002/BL

Dimensiones Ø25cm
Rociador Redondo
Acabado : Blanco mate



Ref. : RDN002/NG

Dimensiones Ø25cm
Rociador Redondo
Acabado : Negro mate



Ref. : RDN003/BL

Dimensiones Ø30cm
Rociador Redondo
Acabado : Blanco mate



Ref. : RDN003/NG

Dimensiones Ø30cm
Rociador Redondo
Acabado : Negro mate





Ref. : RDC001/BL

Dimensiones 20X20cm
Rociador Cuadrado
Acabado : Blanco mate



Ref. : RDC001/NG

Dimensiones 20X20cm
Rociador Cuadrado
Acabado : Negro mate



Ref. : RDC002/BL

Dimensiones 25X25cm
Rociador Cuadrado
Acabado : Blanco mate



Ref. : RDC002/NG

Dimensiones 25X25cm
Rociador Cuadrado
Acabado : Negro mate



Ref. : RDC003/BL

Dimensiones 30X30cm
Rociador Cuadrado
Acabado : Blanco mate



Ref. : RDC003/NG

Dimensiones 30X30cm
Rociador Cuadrado
Acabado : Negro mate





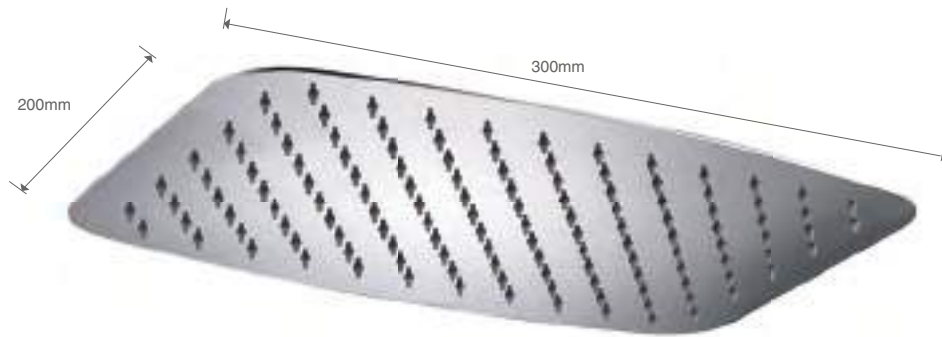

Ref. : RDR001

Dimensiones 20x30 cm
Rociador ovalado extraplano
Material : Acero Inox S304
Acabado : Cromado



Ref. : RDR002

Dimensiones 25x40 cm
Rociador ovalado extraplano
Material : Acero Inox S304
Acabado : Cromado







Ref. : RDF002

Material : Acero Inox S304
Acabado : Cromado

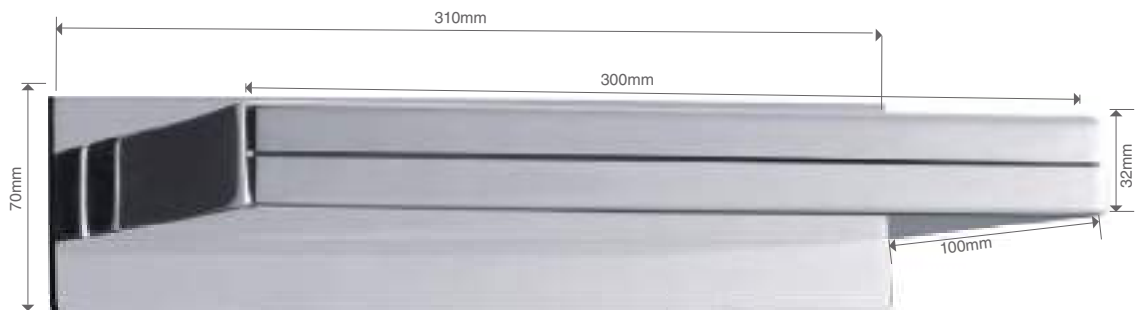

Ref. : RDF003

Material : Acero Inox S304
Acabado : Cromado







Material : Acero Inox S304
 Acabado : Cromado
 Tres salidas
 Incluye premarco

Ref. : **RDG590**
 (dimensiones 59x48 cm)
 Sin premarco

Ref. : **RDG590/P**
 Con premarco (recomendado)



8 410201 234623



8 410201 544623

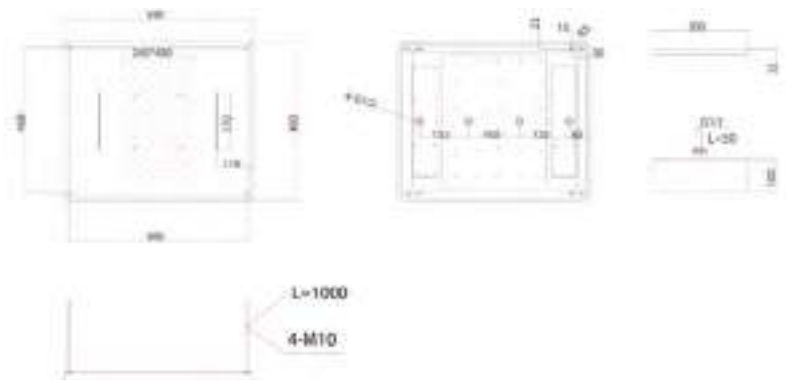

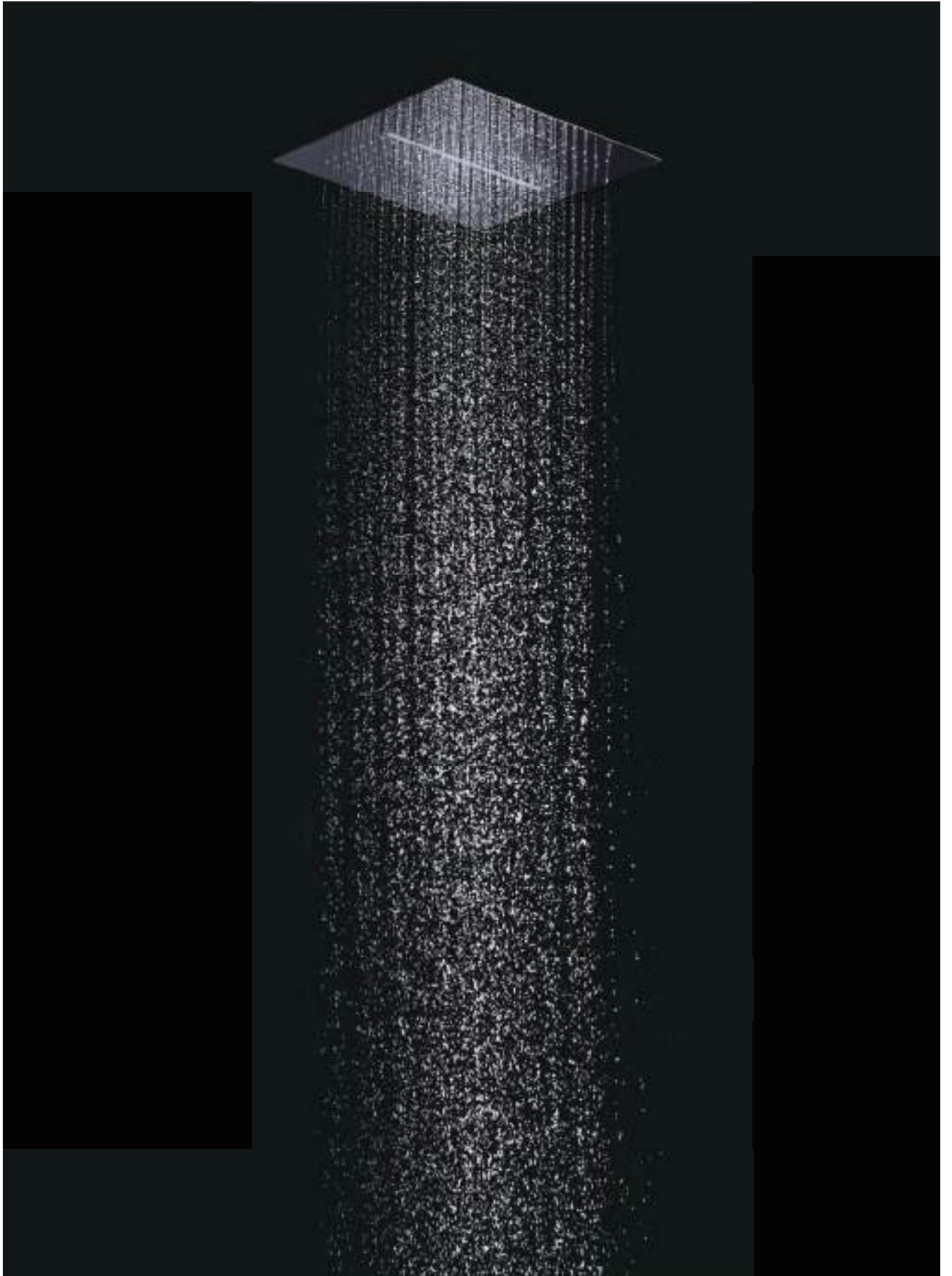



Ref. : **RDG400** (dimensiones 59x48 cm)

Material : Acero Inox S304
Acabado : Cromado
Dos salidas
Incluye premarco

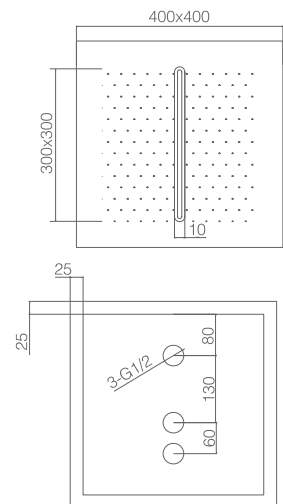





Ref. : RPS490

Material : Acero Inox S304
 Acabado : Cromado
 Rociador cuadrado salida pared
 2 funciones. Efecto lluvia y efecto cascada.

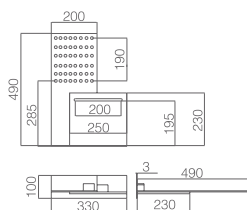

Ref. : RPS490/NG

Material : Acero Inox S304
 Acabado : Negro mate
 Rociador cuadrado salida pared
 2 funciones. Efecto lluvia y efecto cascada.

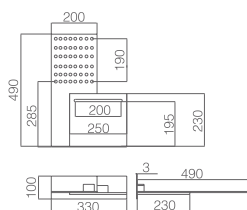

BIDÉS EMPOTRADOS

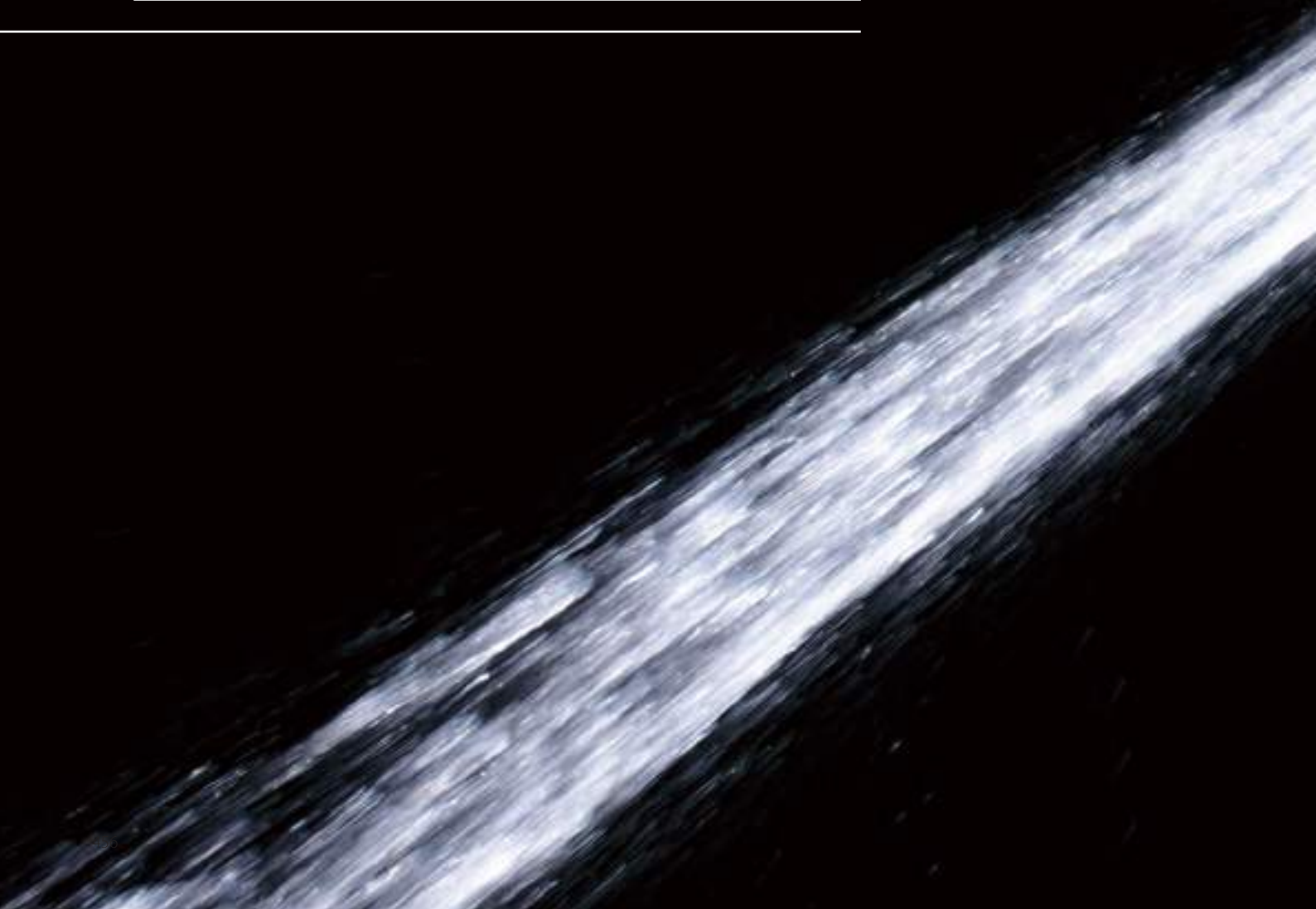





MUNICH

SERIE



Ref. : RDM001

Grifería empotrada de bidé.
Agua fría y caliente.
Mango de 1 posición.
Latón cromado.
Flexo de acero reforzado de 100 cm antiexplosión.
Tapón especial pre-montaje en latón cromado, alta resistencia.



MUNICH NEGRO MATE

SERIE

Ref. : RDM001/NG

Grifería empotrada de bidé.

Agua fría y caliente.

Mango de 1 posición.

Latón negro mate.

Flexo de acero reforzado de 100 cm antiexplosión.

Tapón especial pre-montaje en latón cromado, alta resistencia.







SUECIA

SERIE

Ref. : **BDC032-5/CR**

Grifería empotrada de bidé.
Agua fría y caliente.
Mango de 1 posición.
Latón cromado.
Flexo de acero reforzado de 100 cm antiexplosión.

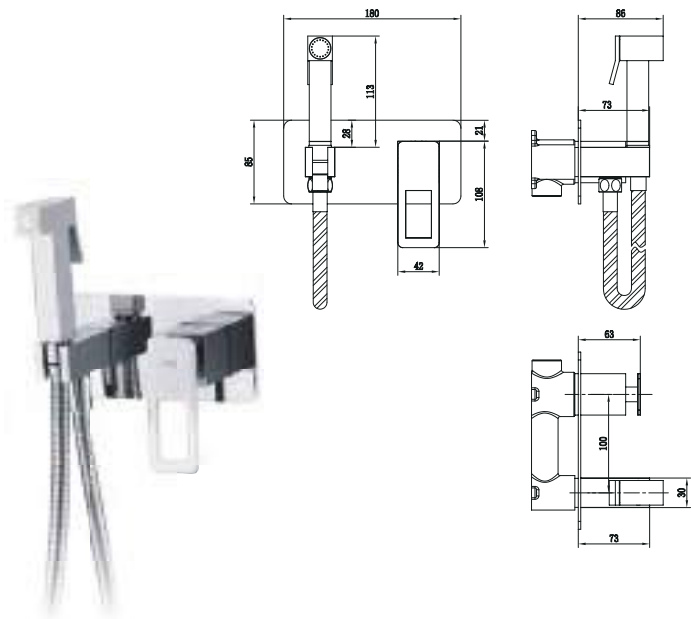



SUECIA

SERIE

Ref. : **BDC032-5/NG**

Grifería empotrada de bidé.
 Agua fría y caliente.
 Mango de 1 posición.
 Latón negro mate.
 Flexo de acero reforzado de 100 cm antiexplosión.

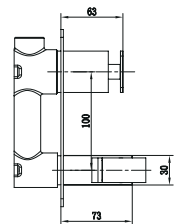
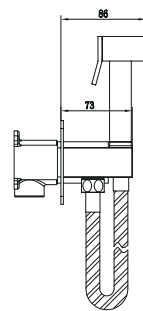
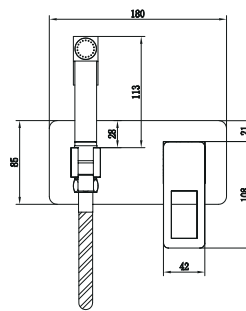





SUECIA

SERIE

Ref. : **BDC032-5/NOR**

Grifería empotrada de bidé.
Agua fría y caliente.
Mango de 1 posición.
Latón negro mate oro rosa.
Flexo de PVC de 100 cm.

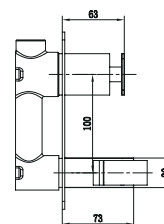
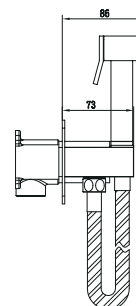
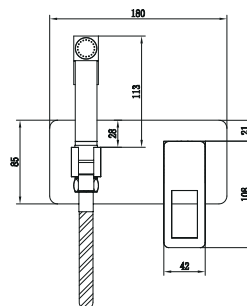



SUECIA

SERIE

Ref. : **BDC032-5/NGOLD**

Grifería empotrada de bidé.
 Agua fría y caliente.
 Mango de 1 posición.
 Latón negro mate oro brillo.
 Flexo de PVC de 100 cm.

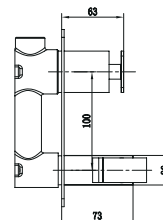
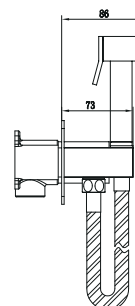
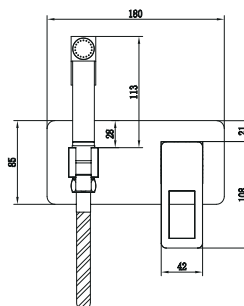





MAUI

SERIE



Ref. : RDM004/CR

Grifería empotrada de bidé.

Agua fría y caliente.

Mango de dos posiciones.

Latón cromado.

Flexo de acero reforzado de 100 cm antiexplosión.





IRLANDA

SERIE



Ref. : **RDM003**

Grifería empotrada de bidé.

Agua fría y caliente.

Mango de 1 posición

Latón cromado.

Flexo de acero reforzado de 100 cm antiexplosión.

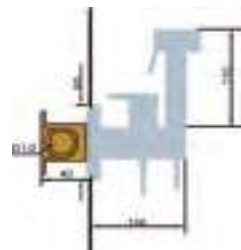

Conexion W.C.



NESS

SERIE



Conexion W.C.

Ref. : **RDM005**

Grifería empotrada de bidé.

Agua fría.

Mango dos posiciones.

Latón cromado.

Flexo acero reforzado de 100 cm.

Latiguillo de conexión al WC no incluido.



ACCESORIOS DE DUCHA



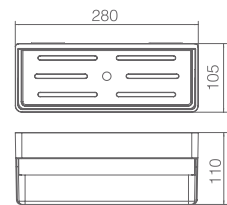

Ref. : **ABL006**

Material : PVC
Acabado : Blanco mate

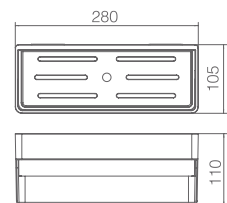

Ref. : **ANG005**

Material : PVC
Acabado : Negro mate





BARRA TOALLERO INTERIOR MUEBLE

Ref.: SPA001

Material : Acero
Acabado : Cromo

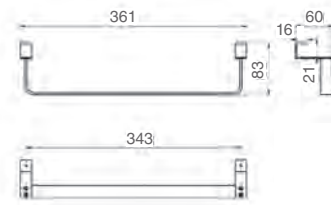

Ref.: SPA001/NG

Material : Acero
Acabado : negro mate







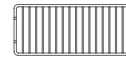
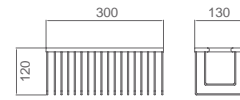

Ref. : **ADF002**

Material : Acero Inox S304
Acabado : Cromado

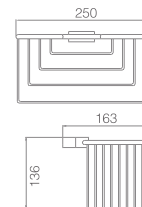

Ref. : **ADB001**

Material : Acero Inox S304
Acabado : Cromado



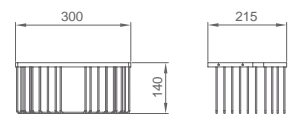

Ref. : **ADR001**

Material : Acero Inox S304
Acabado : Cromado





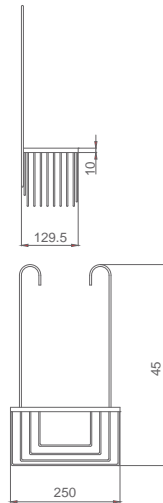
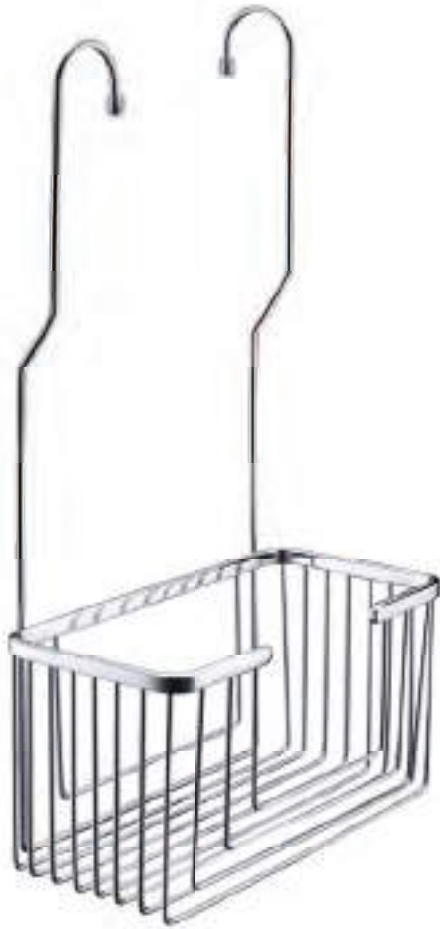

Ref. : ADG003 (PARA GRIFERIA)

Material : Acero Inox S304
Acabado : Cromado



9 780201 374124

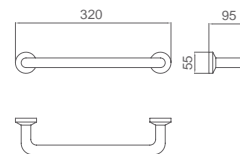

Ref. : AAS004

Material : Latón
Acabado : Cromado



9 780201 374322



MANGOS DE DUCHA



AUSTIN

SERIE



Ref.: MDA008/CR

Modelo Austin cromado
Mangos de ducha 3 posiciones
Mango de ducha de ABS, ergonómico y antical.
Diámetro 12 cm



Ref.: MDA008/NG

Modelo Austin, acabado negro mate.
Mangos de ducha 3 posiciones
Mango de ducha de ABS, ergonómico y antical.
Diámetro 12 cm



Ref.: MDA008/BL

Modelo Austin, acabado blanco mate.
Mangos de ducha 3 posiciones
Mango de ducha de ABS, ergonómico y antical.
Diámetro 12 cm



NEW YORK

SERIE



Ref.: MDN009/CR

Modelo New York

Mango de ducha con pulsador de 3 posiciones

Mango de ducha de ABS, ergonómico y antical

Diámetro 8 cm



Ref.: MDN009/NG

Modelo New York, acabado negro mate.

Mango de ducha con pulsador de 3 posiciones

Mango de ducha de ABS, ergonómico y antical

Diámetro 8 cm



Ref.: MDN009/BL

Modelo New York, acabado blanco mate.

Mango de ducha con pulsador de 3 posiciones

Mango de ducha de ABS, ergonómico y antical

Diámetro 8 cm



HENK

SERIE



Ref.: MDH013

Modelo Henk cromado
Mangos de ducha 1 posición.
Mango de ducha de ABS, ergonómico y antical.



Ref.: MDH013/NG

Modelo Henk negro
Mangos de ducha 1 posición.
Mango de ducha de ABS, ergonómico y antical.



Ref.: MDH013/BL

Modelo Henk blanco
Mangos de ducha 1 posición.
Mango de ducha de ABS, ergonómico y antical.



GENOVA

SERIE



Ref.: MDV014

Modelo Génova
Mango de ducha con pulsador de 1 posición.
Mango de ducha de ABS, ergonómico y antical



Ref.: MDV014/NG

Modelo Génova
Mango de ducha con pulsador de 1 posición.
Mango de ducha de ABS, ergonómico y antical



Ref.: MDV014/BL

Modelo Génova
Mango de ducha con pulsador de 1 posición.
Mango de ducha de ABS, ergonómico y antical



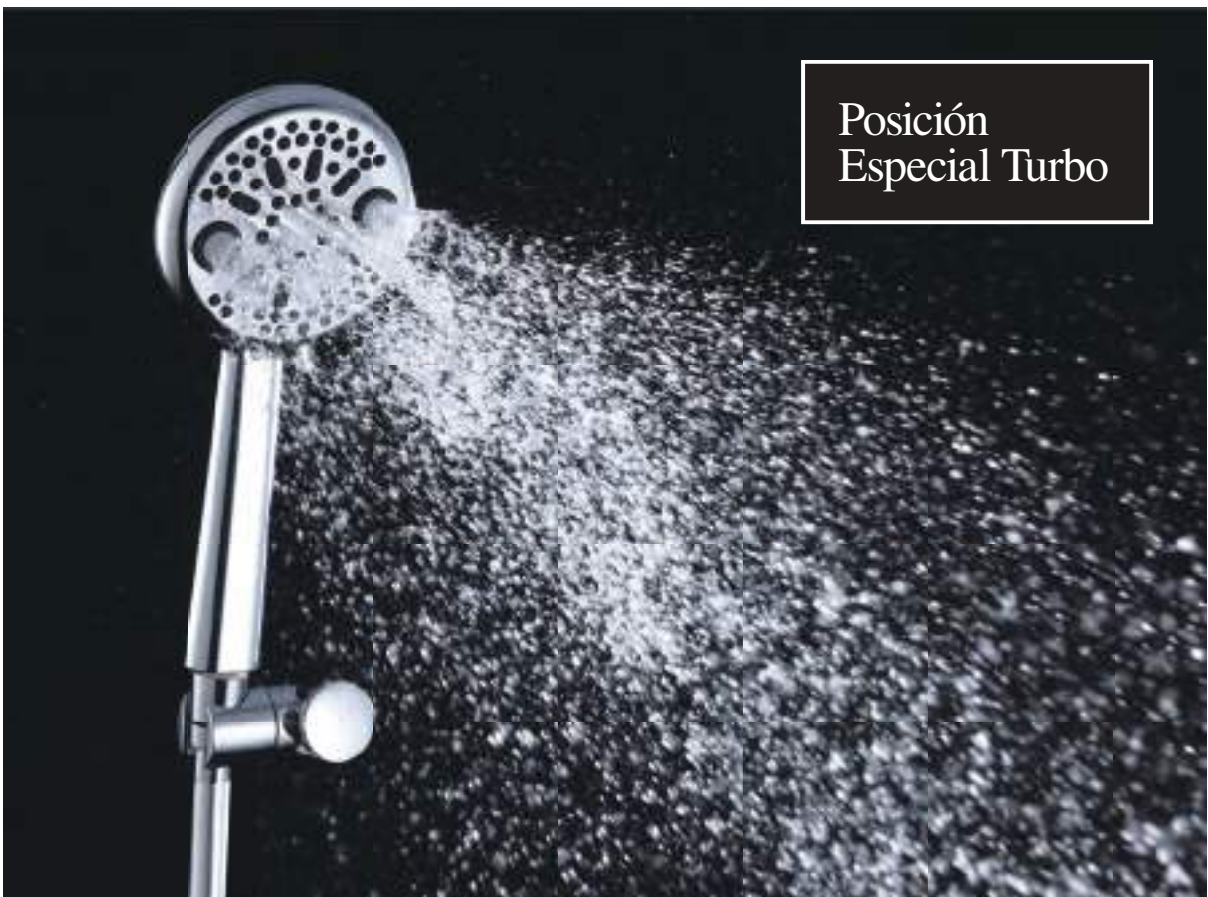



KANSAS

SERIE

Ref. : **MDK011**

Modelo Kansas
Mango de ducha con pulsador de 2 posiciones,
de ABS, ergonómico y antical



NEVADA

SERIE

Ref. : **MDN012**

Modelo Nevada
Mango de ducha 4 posiciones de ABS,
ergonómico y antical
Diámetro 8,5 cm





Ref.: MDD010

Modelo Denver
Mangos de ducha 3 posiciones
Mango de ducha de ABS,
ergonómico y antical
Diámetro 10 cm



Ref.: MDM006

Modelo Miami
Mangos de ducha 3 posiciones
Mango de ducha de
ABS,ergonómico y antical
Diámetro 10 cm



Ref.: MDG004

Modelo Houston
Mangos de ducha 3 posiciones.
Mango de ducha de
ABS,ergonómico y antical
Diámetro 9,5 cm





Ref.: MDC003

Modelo Orlando
Mangos de ducha 2 posiciones.
Mango de ducha de
ABS,ergonómico y antical
Diámetro 9,5 cm



Ref.: MDL005

Modelo Chicago
Mangos de ducha 5 posiciones.
Mango de ducha de
ABS,ergonómico y antical
Diámetro 8,5 cm



Ref.: MDB002

Modelo Boston.
Mangos de ducha 1 posición
Mango de ducha de
ABS,ergonómico y antical
Diámetro 10 cmv



Ref.: MDL001

Modelo Dallas
Mangos de ducha 1 posición
Mango de ducha de
ABS,ergonómico y antical
Diámetro 6 cm



VÁLVULAS DE CLICK CLACK Y COMPLEMENTOS





Ref. : VCC007(blanco mate)

Apta para todos los lavabos y bidés, con o sin rebosadero.
 Sistema de apertura/cierre garantizado para ciclos de 20.000 usos.
 Rosca inferior de 1 1/4.
 Sistema antical.
 Fabricadas en latón, blanco mate integral.
 Montaje rápido y sencillo.



Ref. : VCC003(cerámica blanco brillo)

Apta para todos los lavabos y bidés, con o sin rebosadero.
 Sistema de apertura/cierre garantizado para ciclos de 20.000 usos.
 Rosca inferior de 1 1/4.
 Sistema antical.
 Fabricadas en latón, cromado, con tapa cerámica blanca.
 Montaje rápido y sencillo.



Ref. : VCC008(negro mate)

Apta para todos los lavabos y bidés, con o sin rebosadero.
 Sistema de apertura/cierre garantizado para ciclos de 20.000 usos.
 Rosca inferior de 1 1/4.
 Sistema antical.
 Fabricadas en latón, negro mate.
 Montaje rápido y sencillo.

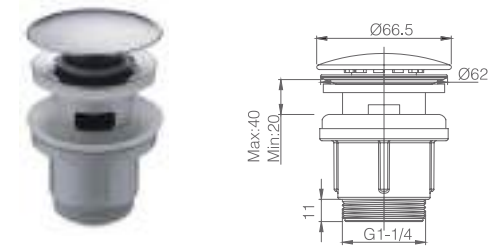

Ref. : VCC009

Apta para todos los lavabos y bidés, con o sin rebosadero.
 Sistema de apertura/cierre garantizado para ciclos de 20.000 usos.
 Rosca inferior de 1 1/4.
 Sistema antical.
 Fabricadas en PVC y acero S304, cromado.
 Montaje rápido y sencillo.



Ref. : VCC010

Apta para todos los lavabos de sobremesa tipo bol.
 Sistema de apertura/cierre garantizado para ciclos de 20.000 usos.
 Rosca inferior de 1 1/4.
 Sistema antical.
 Fabricadas en latón, cromado.
 Montaje rápido y sencillo.
 Sin rebosadero.



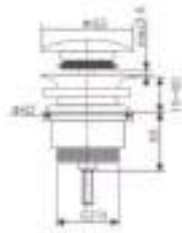

Ref. : VCC001

Apta para todos los lavabos y bidés, con o sin rebosadero.
Sistema de apertura/cierre garantizado para ciclos de 20.000 usos.
Rosca inferior de 1 1/4.
Sistema antical.
Fabricadas en latón,cromado.
Montaje rápido y sencillo.



Ref. : VCC006

Apta para todos los lavabos y bidés, con o sin rebosadero.
Sistema de apertura/cierre garantizado para ciclos de 20.000 usos.
Rosca inferior de 1 1/4.
Sistema antical.
Fabricadas en latón,cromado.
Montaje rápido y sencillo.



Ref. : VCC002

Apta para todos los lavabos y bidés, con o sin rebosadero.
Sistema de apertura/cierre garantizado para ciclos de 20.000 usos.
Rosca inferior de 1 1/4.
Sistema antical.
Fabricadas en latón, cromado.
Montaje rápido y sencillo.



Ref. : VCC005 (Larga)

Apta para todos los lavabos y bidés, con o sin rebosadero.
Sistema de apertura/cierre garantizado para ciclos de 20.000 usos.
Rosca inferior de 1 1/4.
Sistema antical.
Fabricadas en latón, cromado.
Montaje rápido y sencillo.





Ref. : FLX001

Flexo de ducha de acero reforzado,
extensible de 150 a 170 cm.



Ref. : FLX002

Flexo de ducha de PVC de 150cm.



Ref. : FLX003 (Peso 370 gr.)

Flexo de ducha de latón reforzado,
extensible de 150 a 170 cm.



Ref. : FLX004

Flexo de ducha de acero reforzado,
extensible de 170 a 190 cm.



Ref. : FLX005/BL (Blanco mate)

Flexo de ducha de PVC de 150cm.



Ref. : FLX005/NG (Negro mate)

Flexo de ducha de PVC de 150cm.





Ref.: **SFR001**



Ref.: **SFR001/BL** (Blanco mate)



Ref.: **SFR001/NG** (Negro mate)



Ref.: **SFD002**



Ref.: **SFD002/BL** (Blanco mate)



Ref.: **SFD002/NG** (Negro mate)





Ref.: KITR01

Modelo Rex
 Mango de ducha 5 posiciones, de ABS,
 ergonómico y antical.
 Flexo de acero reforzado extensible
 170/190cm, con terminaciones en latón cromado.
 Soporte de ABS orientable y dirigible



Caño de bañera de latón plegable

Material : Latón
 Acababo : Cromado

Ref.: CBP001



Ref.: SCL001

Sifon cromado visto redondo
 Bote sifónico



Material : Latón y zamak
 Acababo : Cromado

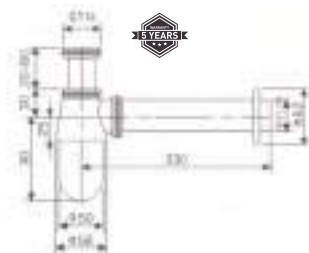



Ref.: **SCL002**

Sifon cromado visto redondo
Bote sifónico



Material : Latón y zamak
Acababo : Cromado

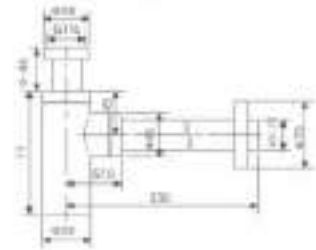

Ref.: **SCL002/BL**

Sifon blanco mate visto redondo
Bote sifónico



Material : Latón y zamak
Acababo : Blanco mate

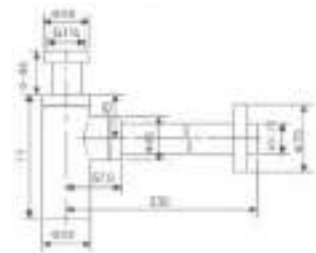

Ref.: **SCL002/NG**

Sifon negro mate visto redondo
Bote sifónico



Material : Latón y zamak
Acababo : Negro mate

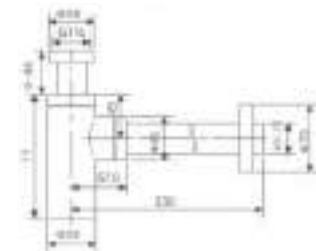

Ref.: **SCL003**

Sifon cromado visto cuadrado
Bote sifónico



Material : Latón y zamak
Acababo : Cromado

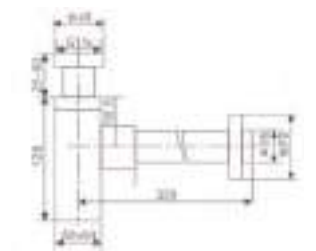

COMPLEMENTOS Y REPUESTOS



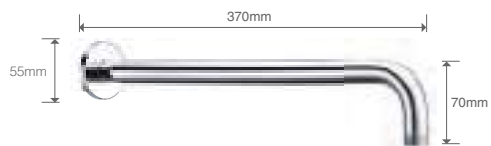

Ref. : **BPR001** (latón)



Ref. : **BPR001/NG**

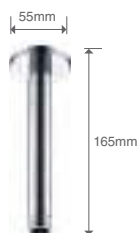

Ref. : **BTR006** (latón)



Ref. : **BTR006/NG**

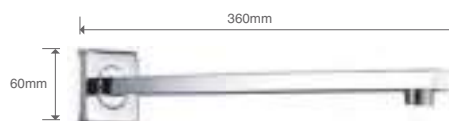

Ref. : **BPC003** (latón)



Ref. : **BPC003/NG**



Ref. : **BTC007** (latón)



Ref. : **BTC007/NG**







Ref.: **BPF002** (latón)



Ref.: **BPC005**



Ref.: **BPC005/NG**



Ref.: **BPE004** (latón)

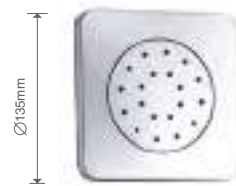

Ref.: **JCD002** (latón)





Ref. :SMD005



8 410201 187622

G1/2"



G3/4"

Ref. :RR0001



8 410201 172628



G3/4"

Ref. :RR0002



8 410201 189626



Ø24mm

Ref. :RR0003



Ø28mm

Ref. :RR0004



8 410201 173625

8 410201 174622



Ref. :SMD006



8 410201 204626



Ref. :RR0006

Cartucho cerámico 35 mm



8 410201 176626



Ref. :RR0007

Cartucho cerámico 35 mm



8 410201 177623



Ref. :RR0005



8 410201 175629



Ref. :SMD004



8 410201 186625



Ref. :RR0017



8 410201 205623



Ref. :RR0008

Cartucho termostatico VERNET



8 410201 176620



Ref. : RR0009

Cartucho termostatico SEDAL



8 410201 179627





Ref.: RR0011

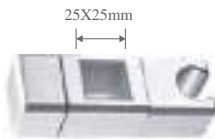

Ref.: RR0016



Ref.: SMD003



Ref.: RR0012

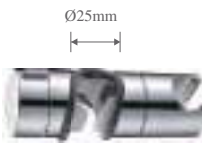

Ref.: RR0014



Ref.: SMD002



Ref.: RR0013

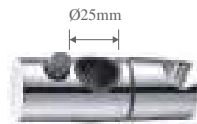

Ref.: RR0015



Ref.: SMD001



MONTAJE SISTEMAS DE DUCHA

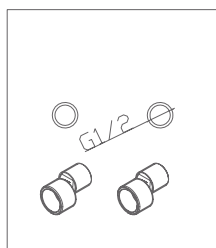

Paso 1

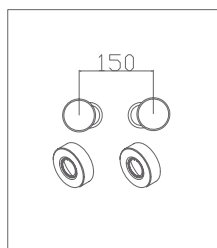

Paso 2

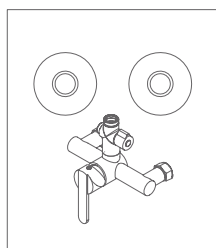

Paso 3

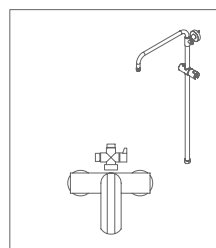

Paso 4

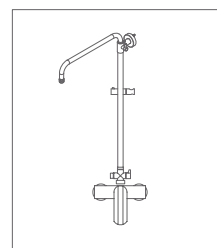

Paso 5

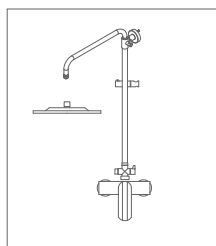

Paso 6

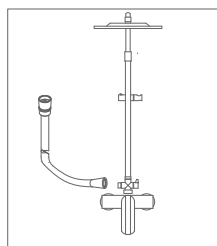

Paso 7

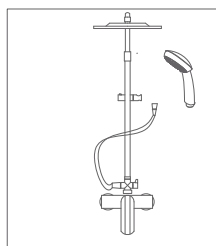

Paso 8

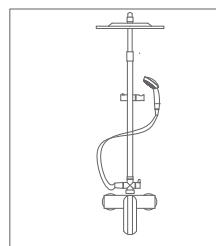

Paso 9

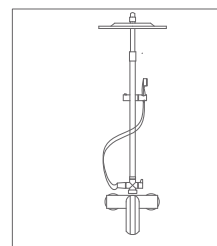

Paso 10

INSTRUCCIONES DE MONTAJE EMPOTRADAS DE DUCHA



Paso 1



Paso 2



Paso 3



Paso 4



Paso 5



Paso 6



Paso 7



Paso 8



Paso 9

INSTRUCCIONES DE MONTAJE MODELO MAUI

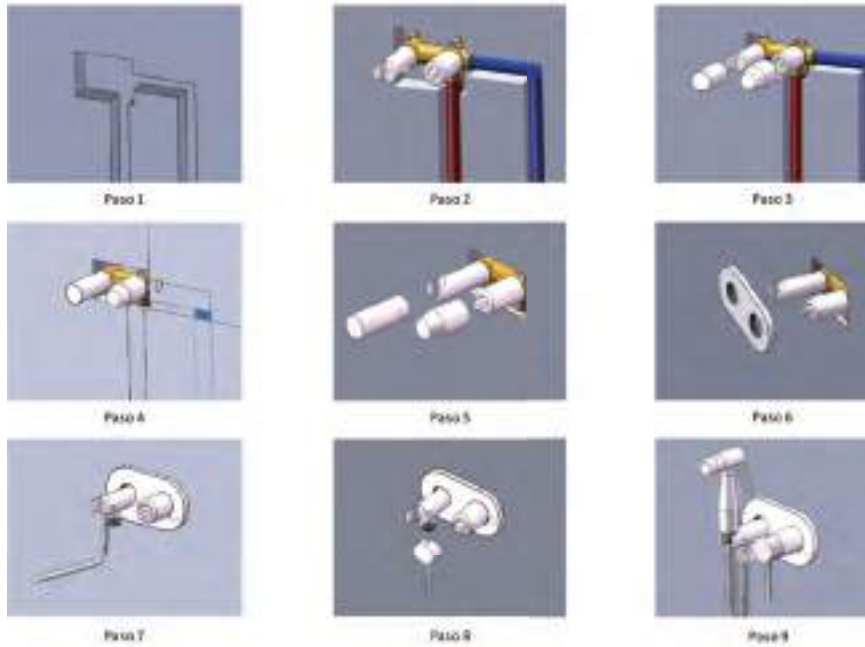

INSTRUCCIONES DE MONTAJE MODELO MUNICH

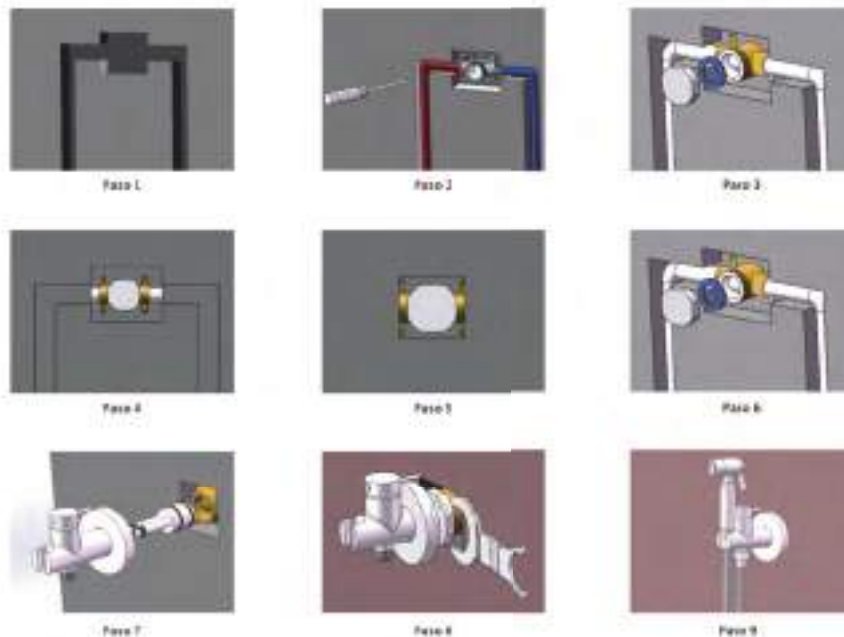

DATOS TÉCNICOS MODELOS MUNICH Y MAUI

- Presión de ejercicio recomendada 1-5 BAR
- Presión máxima de prueba -16 BAR
- Temperatura máxima del agua -80
- Temperatura recomendada -40
- Diferencia de presión entre agua caliente y fría 1.5 BAR
- Se aconseja la instalación de filtros en las entradas de agua.

INSTRUCCIONES DE MONTAJE

- Montar la parte empotrada y poner el azulejo. Respetar las indicaciones de nivel mínimo de azulejo especificado en la pieza.
- Una vez acabado el montaje del azulejo proceder a desmontar la placa protectora desenroscando los tornillos
- Sacar la placa
- Montar el cuerpo vigilando que la goma en forma de 8 (fig. 5/3) no se mueva de la posición original. Posicionar primero los dos tornillos laterales y después los siguientes.

EXPOSITORES



Ref.: 1EXP0015-N



Ref.: 1EXP0015-B



Ref.: 1EXP0017-N



Ref.: 1EXP0017-B

EXPOSITORES



Ref.: 1EXP0020



Ref.: 1EXP0022



Ref.: 1EXP0014-N

EXPOSITORES

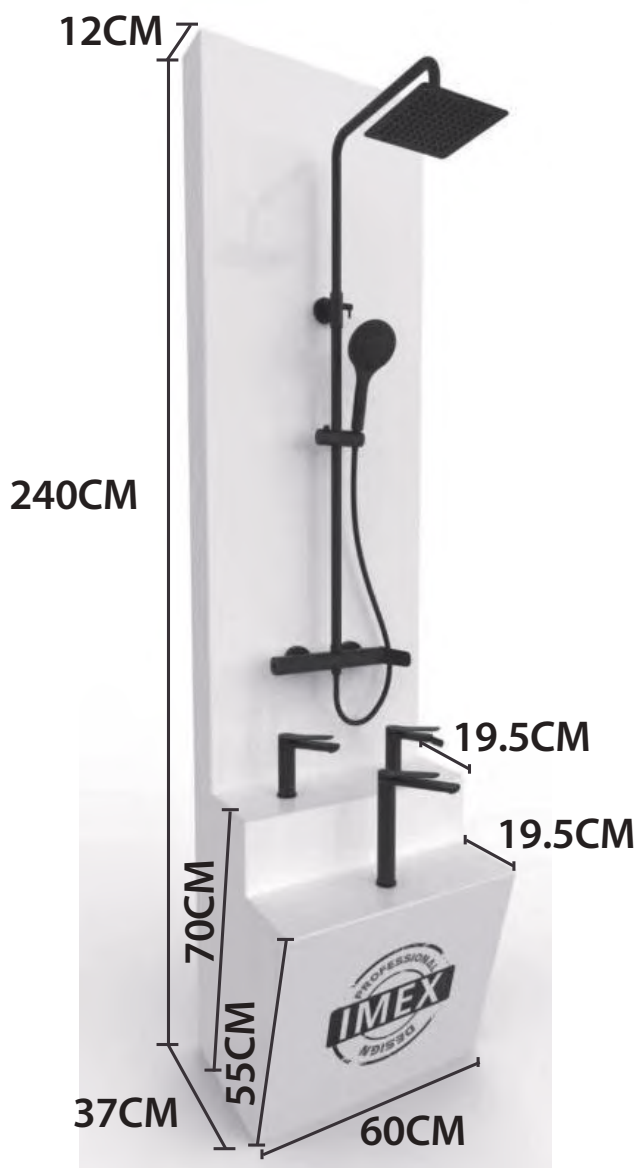

Ref. : 1EXP0019-B



Ref. : 1EXP0019-N

EXPOSITORES



Ref. : 1EXP0024



Ref. : 1EXP0023



Ref. : 1EXP0013-B



Ref. : 1EXP0013-N



Ref. : 1EXP0025

CONDICIONES GENERALES DE VENTA



ENTREGAS

Revise la mercancía a la recepción de la misma.No se aceptará ninguna reclamación sobre mercancía no revisada en el momento de su recepción.El transportista indicará tal efecto en el albarán de entrega.

DEVOLUCIONES

En caso de devolución defina claramente el motivo de la misma.
IMEX aceptará toda devolución que cumpla las siguientes premisas:
-El material deberá tener algún defecto de fabricación.
-El embalaje deberá estar en perfecto estado,de no ser así se le aplicará un recargo de un 10% en factura en concepto de recepción,revisión y manipulación.

FORMA DE PAGO

Se emitirá recibo a través de entidad bancaria.
Giro máximo 30 días fecha factura
Cualquier impagado que se produzca conllevará el pago de la factura más todos los gastos bancarios ocasionados y retención de todos los pedidos hasta el pago del mismo.

TRIBUNALES

En caso de litigio ambas partes se someterán a los tribunales de Torrent (VALENCIA).

PORTES

Se cargarán 5,50 € de portes para aquellos pedidos que no superen 80 €.



IMEX PRODUCTS, S.L.

C/ Hort de Soriano, no 24-26. (Polígono Industrial Mas del Jutge)
46909 Torrent (Valencia)
C.I.F.:B-98301732

AT.CLIENT:

Tel: +34 96 065 12 74

Tel: +34 96 156 63 87

Tel: +34 630 402 947

www.griferiasdeducha.com

e-mail: imex@gestioncompras.com (pedidos y consultas)

exportimex@gestioncompras.com (exportación)

imexproductsserviciotecnico@gmail.com (SAT)